



**HAL**  
open science

# EMR modelling of tidal turbines integrated into Orkney grid

Ahmed Al Ameri, Abdoulaye Koita, Alireza Payman, Mamadou Baïlo  
Camara, Brayima Dakyo

► **To cite this version:**

Ahmed Al Ameri, Abdoulaye Koita, Alireza Payman, Mamadou Baïlo Camara, Brayima Dakyo. EMR modelling of tidal turbines integrated into Orkney grid. *Electric Power Systems Research*, 2021, 201, pp.107548. 10.1016/j.epsr.2021.107548 . hal-03883960

**HAL Id: hal-03883960**

**<https://normandie-univ.hal.science/hal-03883960v1>**

Submitted on 16 Oct 2023

**HAL** is a multi-disciplinary open access archive for the deposit and dissemination of scientific research documents, whether they are published or not. The documents may come from teaching and research institutions in France or abroad, or from public or private research centers.

L'archive ouverte pluridisciplinaire **HAL**, est destinée au dépôt et à la diffusion de documents scientifiques de niveau recherche, publiés ou non, émanant des établissements d'enseignement et de recherche français ou étrangers, des laboratoires publics ou privés.



Distributed under a Creative Commons Attribution - NonCommercial 4.0 International License

# EMR Modelling of Tidal Turbines Integrated into Orkney Grid

Ahmed AL AMERI<sup>1,2</sup>, Abdoulaye KOITA<sup>1</sup>, Alireza PAYMAN<sup>1</sup>, Mamadou Baïlo CAMARA<sup>1</sup>, Brayima DAKYO<sup>1</sup>

<sup>1</sup>GREAH, EA 3220, Université du Havre, 76600 Le Havre, France (ahmed.al-ameri@univ-lehavre.fr)

<sup>2</sup>Electrical Department, University of Kufa, AL Najaf, Iraq ([ahmeds.alameri@uokufa.edu.iq](mailto:ahmeds.alameri@uokufa.edu.iq))

**Abstract**— The main challenges for renewable energy integration in electrical grid system are their variability and prediction. Tidal renewable energy is considered low variability in comparison to wind energy generation and due to tides regular periodicity, it is often quoted as predictable. This paper presents the modeling of Orkney's distribution network with the integration of tidal energy. This multi-physics model is based on the graphical formalism tool, Energetic Macroscopic Representation (EMR). This tool has been used to analyze the Tidal energy conversion (TEC) system based on the behavior of permanent magnet synchronous machine (PMSM). The daily, monthly and yearly variations of marine water speed in Orkney were observed. The EMR has been efficiently used in the representation of Orkney energy system integration of Orbital O2 tidal systems, and showing its effectiveness to adopt the control strategy. More precisely, the data of current water profile for 2009 has been chosen from 10 years big data to test the adopted deduced control technique. The methodology of this tool is described in details and the simulation results obtained in MATLAB environment are presented.

**Keywords**— Tidal energy conversion; Energetic Macroscopic Representation; permanent magnet synchronous machine.

## 1. INTRODUCTION

Long before humans catch fossil fuels, it learned how to harness the power of water to do the work. Subsequent generations realized that mobile water could be used to power an electric turbine. Government and academic estimates indicate that marine renewable energy can provide a large share of electricity used in coastal areas, tidal energy products often indicating that technologies provide reliable and in-place electricity. After all, waves and tides can be predicted.

The power generation systems of marine current are produced by converting the mass of water flow (kinetic energy) into electrical energy. The marine current speed is daily changed through two tidal phases when the water level is falling (Ebb) and rising (flood) as shown in Fig. (1a). In addition, the system has a season variation due to the speed change of marine current during the high tides months (at spring tides when sun, moon and earth are aligned) to the low tides (at neap tides when moon is perpendicular on earth) as shown in Fig. (1b)[1]. **Compared to other renewable energies such as (wind and solar), the tidal turbines have higher efficiency (80%).**

As the ocean energy has the largest renewable resource on the world (approximately  $2 \times 10^3$  tW, many countries have been invested to accelerate the development of this energy. In France, the oldest and second biggest station of tidal

power has been operational with 240MW since 1966 [2]. The Électricité de France (EDF) which is the biggest utility company in France, has an annual capacity of 540 GWh generation from La Rance tidal power plant.

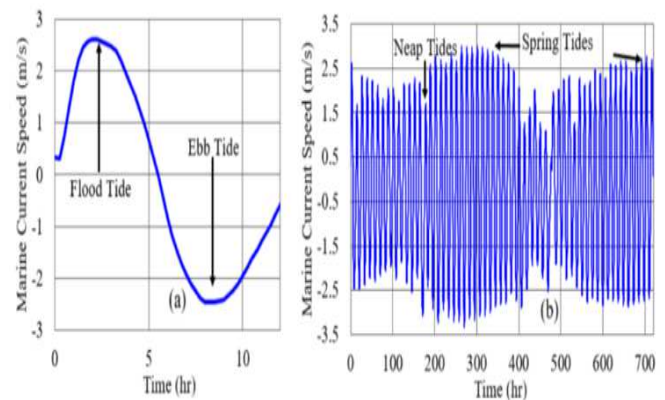


Fig. 1 Variation of Marine Current Speed by a) day b) season

Many other countries recently starting to put a lot of attention in this kind of energy such as UK, Canada, Russia, China, India, Brazil, South Korea, etc. In 2011, the world's largest station of tidal power has been completed with 254MW total power capacity [3]. This plant was constructed by Daewoo Engineering & Construction and designed to produce 552.7GWH annual generation capacity for the owner (Korea Water Resources Corporation). In 2013, the planning for project of 240MW has been approved to be construct at Swansea Bay in the UK. The Swansea Bay Tidal Lagoon has been estimated to generate 400GWh annual power capacity [4], that will make it upon completion as the world's third biggest project in tidal energy.

Numerous states of the arts have been performed onto tidal energy simulation and technologies. The general tidal signals have been studies based on the review of tidal wave theory principle, sedimentary successions, and several tidal coasts (mega, macro, micro and meso) [5]. The development of tidal technologies has been more interested to reduce the initial cost, maintenance cost, and improve the two-way efficiency. The new turbines with possible range applications of tidal has been selected includes Archimedes screw, a counter-rotating turbine, the modified bulb turbine with two groups of guide vanes, and a gyro device [6].

That has been so interesting for the researchers to explore the different aspects of usage the tidal energy systems. Therefore, the development of mathematical models has been simulated with several methods to analyze the fundamental interaction between the various parts of a power conversion system. The European Centre for Marine Energy

(EMEC) as built in UK as one of the most important development centers. The world leader center in the investigation of “instream tidal energy has been constructed in Canada as known Fundy Ocean Research Centre (FORCE) [7].

Several tidal technologies have been simulated to integrate into grid. Numerical simulations to analyze the tidal plant in French Atlantic coast has developed to improve the economic issues [8]. Authors proposed storage strategy based on the underwater pumped storage energy. In Canada, because of the installation policy limits, it has been proposed to use the tidal energy of the Bay of Fundy to be installed and integrated into grid. The energy storage system (ESS) has presented into model to enable the installation of tidal energy converter (TEC) [9].

Another proposal to reduce the highly fluctuation into tidal energy system has been modeled based on Maximum Power Point Tracking (MPPT) and (ESS). The supercapacitor (SC) has been used to compensate and control the fluctuation of power injected into the grid [10]. Tidal energy as part of hybrid renewable system has been evaluated based on the real data for three regions of Iran [11]. In China, Jiangxia Tidal Power Station (JTSP) has been analyzed and evaluated in term of economic and energy compared to other types of renewable energies [12].

The graphical formalism tool is one of the most interesting methods which have been used represent the complex and multi-physic systems. In 2000, the Energetic Macroscopic Representation (EMR) as new graphical formalism method was developed to describe conversion systems [13]. EMR has been proposed to analyze many conversion systems: Koita et al [14] have used the EMR tool to control a wind energy conversion system include permanent magnet synchronous generator (PMSG).

Hydrogen energy system converted to electricity by using Proton Exchange Membrane (PEM) electrolyzers and PEM fuel cells used to back-up renewable energy sources based on the EMR model [15]. Barakat et al [16] have studied a 1.5 MW wind turbine based on PMSG using EMR to minimize the generation losses by controlling the converter systems. The EMR modelling approach has been applied on the French railway company (SNCF) to evaluate the efficiency of new railcar based on the performance of reverse engineering [17].

Also, several researchers have applied Energetic Macroscopic Representation to storage energy systems such as a fuel cell supercapacitor system [18], Proton Exchange Membrane (PEM) electrolyser [19], and hybrid storage system used fuel cell battery and supercapacitor for electrical vehicle [20]. The EMR has been used to model the hybrid powertrain simulator based on the dynamic system of supercapacitor and fuel cell [21]. Internal Combustion Engine (ICE) has been modelled by EMR to explore the heat energy on the vehicle subsystems behaviors. The methodology of EMR enables the developed EMR simulator and the integration elements of inversed-based control loops guaranties the simplicity to study the multiphysical system.

More complex electromechanical systems has been represented by EMR tools to model the dynamic nonlinear [22]. The EMR modeling of multi-physics presented here allows the highlights the interactions of simple subsystems the heat transfer, electromechanical, and fluid mechanics that occur in Compressed Air Energy Storage system. Another research in dynamical multi-physical model of vehicle engine is developed by EMR tools in [23]. Various models of the Internal Combustion Engine subsystems has been interconnected in EMR design to compare the simulation of quasi-static and dynamical model.

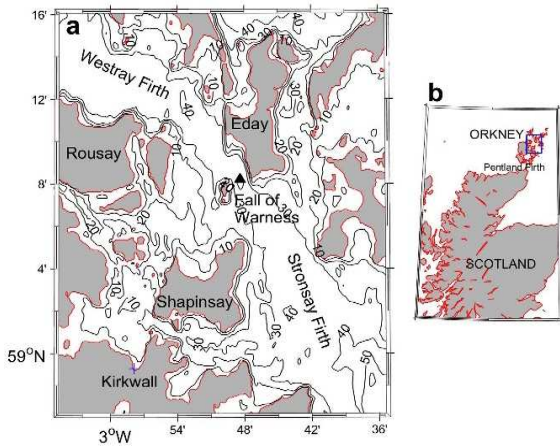
Energy is play important role to drive the modern economy, therefore analysis, modeling and simulation of complex energy systems (such as tidal energy) has received significant research attention. The marine current energy conversion system is convert the water kinetic energy to electrical energy. The process of conversion system required to develop different subsystems such as (tidal turbine, permanent magnet synchronous generator, the power electronic converters and the demand side). In additional, the dynamic behavior of each subsystem can be described as multivariable system. The main contribution of this work is to analysis and modelling the tidal energy system and the control strategy based on MPPT by using the EMR approach and read data. The EMR of the tidal conversion system facilitates the understanding of the interactions between its different subsystems. This work is a case study focus on tidal energy in Orkney Islands, UK which is part of a European project under construction. Real data of 10 years water profile has analyzed to apply in this model by using EMR tools. This method has been applied to control the injected of reactive power into grid the speed of PMSG and the voltage of DC bus.

This paper has organized firstly by disciple the system components and data. Next, the methodology of EMR has been figure out in details. In third section, model of each part has been illustrated then graphical tools represent the whole system. The simulation results and conclusion has been demonstrated in sections four and five respectively.

## 2. OKNEY SYSTEM

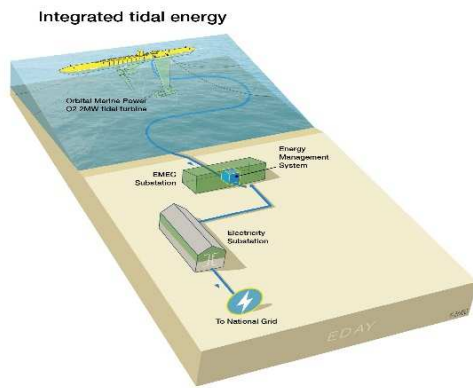
The west coast of Orkney has lot of interesting in research as it consider one of the largest tidal energy in the world. Many extensively studies has been researched for this region and it selected to be host test centers with support of academic and governmental of Scotland. That lead to established the European Marine Energy Centre (EMEC) in 2003 to develop the marine energy industry and enhance the marketing progress of tidal energy [24].

This paper will consider the integration of 2MW tidal energy (Orbital O2) into Orkney grid which is belong to project lead by Interreg North-West Europe and EMEC. In this site, the speed of tidal currents exceed 3m/s with suitable water depths in many locations in the Firths of Orkney and Pentland Firth as shown in Fig. 2.



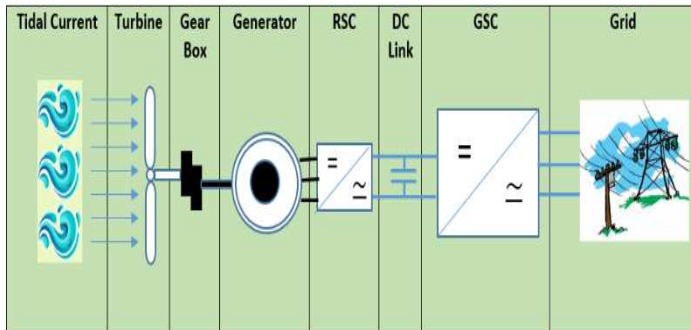
**Fig. 2 a/** the Firths of Orkney, **b/2MW** tidal turbine site of installation

The Orbital O2 turbine connected to Orkney grid through energy management system (EMS), Fig. 3. The strategy of controlling the power flow can be presented by control generator side converter (GSC), grid side converter (GSC), and DC link. This turbine has been designed to 16m rotor diameter, 11kv, 50 Hz, and 16rpm. The rated current speed is 3m/s while the cut in and cut out current speed rated 1m/s and 4.5m/s respectively.



**Fig. 3** system configuration

The main parts of Integrating Tidal energy into the European Grid (ITEG) project shown in the single line diagram include all sub-systems Fig. 4.



**Fig. 4** Single line diagram for ITEG project

### 3. ORKNEY WTARE PROFILE

When the water is constrained by channels, islands and headlands, the tide drives water movement and consequently the tidal currents occur. The main advantage of tidal resources compared to other renewable energies is the predictability of its characteristic. The power produce by tidal farm can be accurately estimated and its influence on the grid can be forecasted. However, the large tidal variability will present challenges for the power system.

The rotational and gravitational forces between the earth, sun and moon that lead to move water (drive tides) in different directions. The main cause of the tide currents is the moon; however, the sun and moon have relative influence over the seasons of a year. This outcome in variations in the height of tide on a number of time (daily, monthly and yearly) scales.

Generally, in several regions, the speed rate of tidal currents is under 1 m/s, but the spring tidal current amplitude in many locations in Scotland exceed 2.5 m/s. In particular, the tidal stream energy of Orkney is recognized by EMEC as the one of the largest potential tidal resource sites in the world. An extensively studied has been focused in this region and several models proposed [24] and [25]. These research illustrates that tidal wave required 2.5h to propagate around Orkney in a clockwise direction. Thus, a strong gradient flow generates through the Firths of Orkney and Pentland (Fig. 5), which make it suitable for generation of tidal turbine with present of water depth.



**Fig. 5** Charts of Orkney

In 2003, EMEC as established to be hos test center include different supports such as government, academic local industrial and natural environment. In addition to offer “open sea sites”, EMEC has extended to develop “scale tide site”. The collected data and models have been extensively focused on the tidal speed profiles for the Firths of Orkney (more than 7 Berths). The data of speed profiles was for different periods (daily, monthly and yearly) during 10 years (from 1 Jan 1996 to 31 Dec 2005) (Fig. 6).

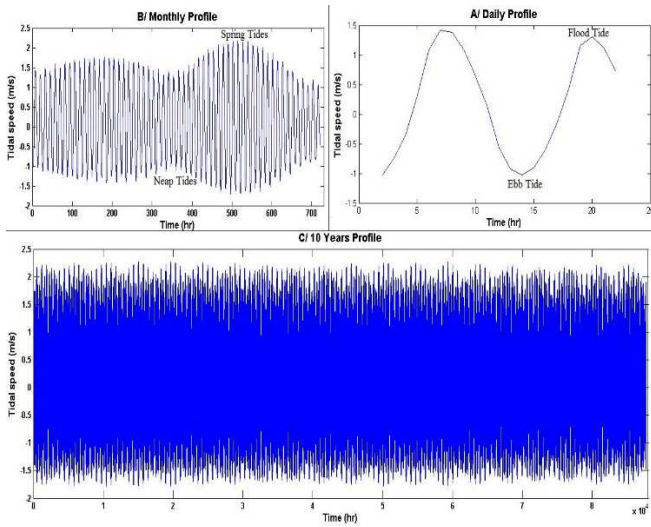


Fig. 6 10 years current speed profiles for Orkney

To precise the effect of current speed profile on the tidal turbine energy system, daily, monthly and yearly models has been initiated.

#### 4. ENERGETIC MACROSCOPIC REPRESENTATION FOR ORKNEY SYSTEM

As the Orkney system consist of tidal energy system, several conversion units and grid, the EMR can be accurate tool to represent these parts. Moreover, compared to other graphical tools, EMR is more readability with a clear synthetically and easily to model the multi-physical systems.

The main elements of EMR are: the source elements, conversion elements, accumulation and coupling elements as shown in Table 1. It is mentioned that in this graphical tool, the output of the action vector by the reaction vector is normally equivalent to the energy at the entry and exit points of each element. Furthermore, the connection of two different elements is possible only if the exit of element 1 is equal to the entry of next element and the entry of element 1 is equal to the exit of next element.

Table 1 EMR elements

Element	Source	Conversion	Accumulation	Coupling
Diagram		<p>Mono-physical</p> <p>Multi-physical</p>		<p>Mono-physical</p> <p>Multi-physical</p>

In order to explain the application EMR, an example of a conversion system from electrical to thermal domain is

figure out in Fig. 7. In this form of energy conversion, the actions are represented by the current and entropy flow in electrical and thermal domain, respectively, while the reaction variables are highlighted by the overvoltage and temperature [26].

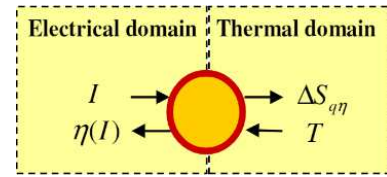


Fig. 7 Energetic conversion from electrical to thermal domain

EMR provides insights into the operation of real energy systems and permits a deep comprehension of its abilities from a dynamic viewpoint. Compared with other non-causal modelling tools, EMR give attention to function of the system in additional to the structure. Moreover, it has contributes to the control design of system much greater than causal modelling tools. The main differences between the graphical formalism tools that used to analysis the multi physical conversion systems has presented in Table 2.

Table 3 Comparison of graphical tools

BG	CIG	PFD	EMR
Ability to multi physical modeling			
++	+	+	+
Ability to control			
-	+	-	+
Physical causality			
Integral/derivative	Integral	Integral	Integral
Structural systemic			
Structural	Functional	Functional	Structural/Functional

The application of the EMR to the different parts of the system can be demonstrated in the following sections.

#### 5. APPLICATION OF THE EMR TO THE TEC SYSTEM

The Orkney system consist of tidal energy conversion (TEC) system integrated into Orkney grid (Fig. 4). The chain of TEC consists of a tidal turbine based on PMSG after used the blade and gearbox to have the mechanical energy. Electrical conversion and control system representing by three phase bridge rectifier, a DC-bus step then an inverter.

The tidal power generation systems convert the water kinetic energy into electrical energy. The tidal conversion system consists of mainly of the tidal turbine and the PMSG. Each component of system has the equations that describe its performance. The control model to find the MPPT (Maximum Power Point Tracking) of tidal turbine based mainly on setting control values. The main elements of EMR are represented by the source elements (marine current and network), conversion elements (blades, rectifier, inverter and

transformer), accumulation (shaft, DC bus, and transmission line), and coupling elements (TEC control system).

As indicated before, the tool of EMR is based on the connected elements and their action and reaction. The EMR block-diagram form for the Orkney system is shown in Fig. 7. Then, Fig. 8 show the structure of EMR after added specific TEC control by using inversion rules. These structures in details are explained as follows.

### 5.1 EMR without control

The transition from Fig. 7 to the EMR of Orkney system with controlling in Fig. 8 by identifying the functions of the parts and the equivalent elements for each of them, which can details as follows:

#### Blades

The blades convert tidal source as kinetic energy into mechanical energy in the shaft, which can be represented as:

$$\Gamma_{Blades} = \frac{P_{Blades}}{\Omega_{Shaft}} = \frac{\rho_{air} \cdot \pi \cdot R_{turbine} \cdot C_p \cdot V_{tidal}^3}{\Omega_{Shaft}} \quad (1)$$

$\Gamma_{turbine}$  is turbine torque,  $P_{turbine}$  is turbine power, and  $\Omega_{Shaft}$  is shaft speed.

$R_{turbine}$  is turbine radius,  $V_{tidal}$  is speed of tidal current, and  $C_p$  is power coefficient of the turbine. The relation between the rotation speed of blades and the output power characteristics is shown in Fig. 8. The EMR of this part is a mono physical conversion because it convert the kinetic energy into mechanical energy.

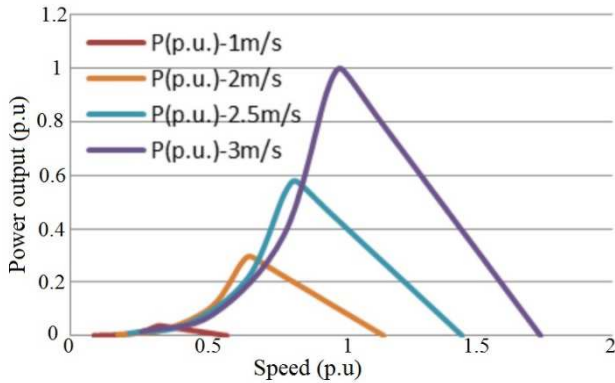


Fig. 8 Set of power output of the tidal turbine system

#### Shaft

The speed rotation of the turbine shaft can be calculated by equations below:

$$J_{shaft} \frac{d\Omega_{shaft}}{dt} = \Gamma_{pmsg} - \Gamma_{Blades} - f_v \cdot \Omega_{shaft} \quad (2)$$

$\Gamma_{pmsg}$  is the mechanical torque of the PMSG,  $\Gamma_{Blades}$  is the shaft torque of the load,  $f_v$  is friction, and  $J_{shaft}$  is inertia constant.

The tidal turbine can modeling mathematically by considering these equation as in Fig. 7.

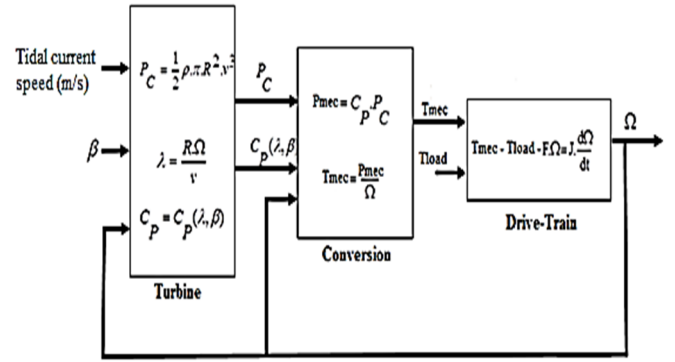


Fig. 9 Mathematical model of tidal turbine

#### PMSG conversion

The PMSG is represented in EMR by a multi-physical elements, firstly conversion element that derived by [14]

$$\Gamma_{pmsg} = 1,5 \cdot P \cdot \phi \cdot I_{q_{pmsg}} \quad (3)$$

$P$  number of poles pair,  $i_{dq_{pmsg}}$  PMSG current in  $dq$  axis and  $\phi$  magnetic induced flux.

Then secondly by accumulation element

$$I_{d_{pmsg}} = \frac{1}{L_d} \int (e_{d_{pmsg}} + V_{d_{pmsg}} - R_s \cdot I_{d_{pmsg}}) \cdot dt \quad (4)$$

$$I_{q_{pmsg}} = \frac{1}{L_q} \int (-e_{q_{pmsg}} + V_{q_{pmsg}} - R_s \cdot I_{q_{pmsg}}) \cdot dt \quad (5)$$

$I_{dq_{pmsg}}$ , PMSG current in  $dq$  axis,  $V_{dq_{pmsg}}$ , stator voltage in  $dq$  axis.

#### Rectifier

$$I_{rect} = -\left(\frac{V_{r1}}{U_{cap}} I_a + \frac{V_{r2}}{U_{cap}} I_b + \frac{V_{r3}}{U_{cap}} I_b\right) \quad (6)$$

$I_{abc}$ ,  $I_{rect}$  PMSG current in  $abc$  axis and current for rectifier respectively, and  $U_{cap}$ , DC bus voltage, PWM switching signals,.

#### DC bus

$$U_{cap} = \frac{1}{C} \int (I_{rect} - I_{inv}) \cdot dt \quad (7)$$

$I_{inv}$  is DC bus current.

#### Inverter

$$I_{inv} = \frac{U_{inv13}}{U_{cap}} i_{line1} + \frac{U_{inv23}}{U_{cap}} i_{line23} \quad (8)$$

$U_{inv13}$ ,  $U_{inv23}$  voltage between inverter phases.

#### Line impedance

$$i_{line1} = \frac{-K_{line}}{3(\tau_{line.s+1})} [2(U_{tr13} - U_{inv13}) - (U_{tr23} - U_{inv23})] \quad (9)$$

$$i_{line2} = \frac{-K_{line}}{3(\tau_{line} \cdot s + 1)} [2(U_{tr23} - U_{inv23}) - (U_{tr13} - U_{inv13})] \quad (10)$$

$U_{tr13}$ ,  $U_{tr23}$ , is voltage between transformer phases,  $K_{line}$ , static gain of the line,  $\tau_{line}$ ,  $i_{line1}$ ,  $i_{line2}$ , time constant, lines currents.

### Transformer

$$i_{tr1} = m_{tr} \cdot i_{line1} \quad (11)$$

$$U_{tr13} = m_{tr} \cdot U_{grid13} \quad (12)$$

$i_{tr1}$ ,  $i_{tr2}$ , current injected into the network and  $m_{tr}$  is transformer transformation ratio.

Each part of conversation system has been represented as one a conversion element such us rectifier, inverter and transformer. The accumulation elements has been used to model the continuous bus and line impedance.

## 5.2 EMR and control structure

The control structure of the system is consist of into two main parts, firstly the speed control of PMSG by using the MPPT in the tidal side and secondly in the grid side by

using PI controllers for reactive power into DC bus voltage. These control elements to represent these two static converters are added to EMR diagram as blue blocks in Fig. 9. To deduce the chain of control structure for the tidal energy conversion system, the following inversion procedures will be considered:

### Shaft inversion:

$$\Gamma_{shaft\_ref} = Cont_{shaft} \cdot (\Omega_{shaft\_ref} - \Omega_{shaft\_mes}) \quad (13)$$

$\Gamma_{shaft\_ref}$ , static gain for shaft equation inversion,  $\Omega_{shaft\_mes}$ , shaft speed measured,  $Cont_{shaft}$  correction coefficient for shaft torques and  $\Omega_{shaft\_ref}$ , shaft speed reference.

### PMSG Conversion and accumulation inversion

$$iq_{pmsg\_ref} = \frac{1}{1.5} \phi \cdot P \cdot \Gamma_{pmsg} \quad (14)$$

$$Vd_{pmsg\_ref} = Cont_{PMSG} (id_{pmsg\_ref} - id_{pmsg\_mes}) - ed_{pmsg\_mes} \quad (15)$$

$$Vq_{pmsg\_ref} = Cont_{PMSG} (iq_{pmsg\_ref} - iq_{pmsg\_mes}) + ed_{pmsg\_mes} \quad (16)$$

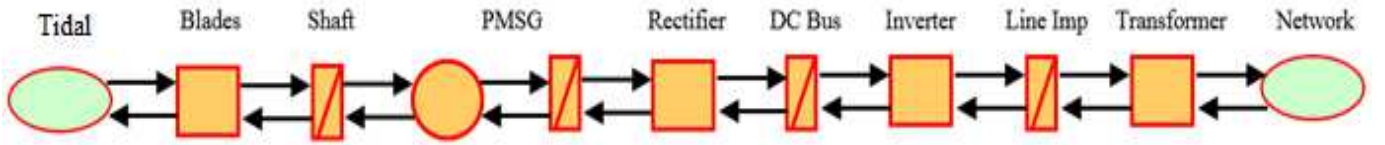


Fig. 10 elements of the tidal energy conversion

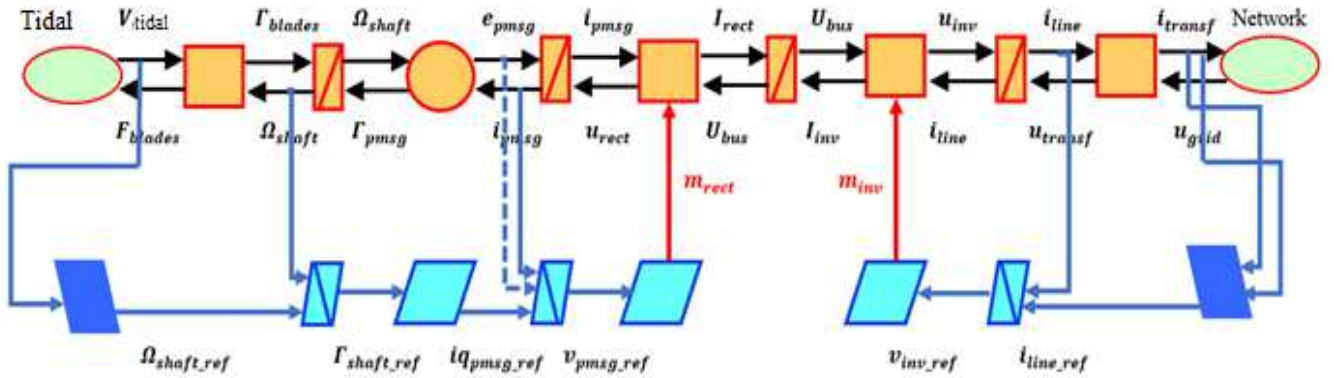


Fig. 11 Structure of EMR for TEC control

### Line impedance inversion

$$Vd_{inv\_ref} = Cont_{line} \cdot (Id_{line\_ref} - Id_{line\_mes}) \quad (17)$$

$$Vq_{inv\_ref} = Cont_{line} \cdot (Iq_{line\_ref} - Iq_{line\_mes}) \quad (18)$$

$Cont_{line}$ , voltage correction coefficient for inversion,  $Id_{line\_ref}$ ,  $Id_{line\_mes}$ ,  $Iq_{line\_ref}$ ,  $Iq_{line\_mes}$  currents reference and measured for rectifier line.

### Control Strategies:

$$\Omega_{shaft\_ref} = \frac{\lambda_{opt}}{R_{turbine}} \quad (19)$$

$$Id_{line\_ref} = (U_{dc\_ref} - U_{dc\_mes}) \cdot Cont_{dc} \quad (20)$$

$$Iq_{line\_ref} = (Q_{ref} - Q_{mes}) \cdot Cont_q \quad (21)$$

$$Q_{mes} = U_q \cdot I_d - U_d \cdot I_q \quad (22)$$

$\lambda_{opt}$ , optimal ratio between tidal speed and turbine,  $U_{dc_{ref}}$ ,  $U_{dc_{mes}}$ , dc bus voltage reference and measured,  $Q_{ref}$ ,  $Q_{mes}$ , reactive power reference and measured,  $Cont_{dc}$ , corrector coefficient for reactive power in DC bus.

## 6. SIMULATION RESULTS

The Orkney system has been represented by EMR for the tidal energy system including the schematic of the control chain as in Fig. 9. The simple structure of this diagram is one of the main advantages of this graphical tool, compared to the simulation on MATLAB Simulink, this scheme can be readable more easily.

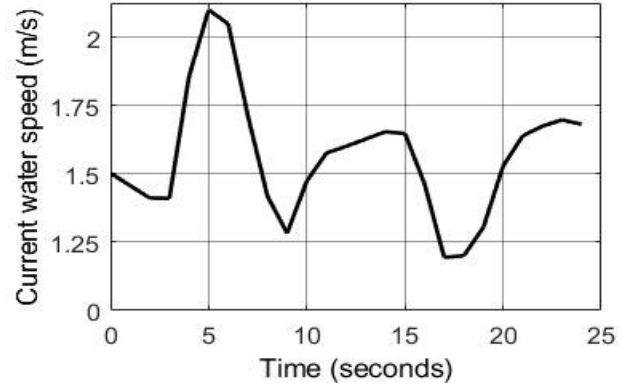
The setting parameters for the system has been details in Table 2. The simulation was performed in different duration (1 day, 1 month and 1 year) to examine the influence of water profile in the grid connected tidal energy. Indeed, the velocity vector of water flow around Orkney Island is complicated pattern. In practical, the magnitude and direction of tidal current velocity vector change with time. In this study, the rapidly change in time for the tidal current direction will not considered. The tidal speed profiles have been measured and extensively focused on for the Firths of Orkney (more than 7 Berths). The total periods for data of speed profiles (daily, monthly and yearly) were collected during 10 years (from 1 Jan 1996 to 31 Dec 2005). **The mode, median and percentile (1m/s=44th) of current water profile are (0.953367, 0.0532844, 46.96), respectively.**

**Table 4** Data for Orkney system

Power coefficient of the turbine	$C_{pmax} = 0.5439$
Cut-in, Cut-out, average water speed	1m/s, 4.5m/s, 3m/s
Turbine radius	16 m
PMSG Machine data	$R=6.25m\Omega$ , $L=4.229$ mH and $\varphi=11.1464$ Wb
Impedance of line	0.5 mH
Capacitance of DC bus	0.06 F

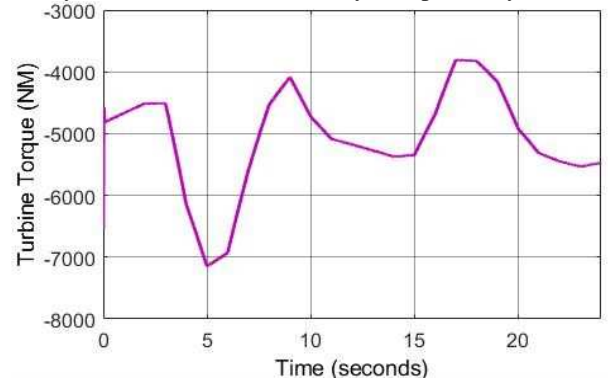
For the simulation, a water profile of an average value of 1.6 m/s (Fig. 10 ) is used for (24, 720 and 8784) seconds for represent (daily, monthly and yearly) duration, respectively. The effective rotor turbine has a diameter of 20 m **and the rated voltage is 11 Kv**. The smooth pole machine is used with  $L=4.229$  mH and  $\varphi=11.1464$  Wb. The line has an impedance of 0.5 mH and  $0\Omega$ . The DC bus has a capacity of 0.06 F.

The profile of the power of the turbine developed during 24 seconds (such as each 1 second represent 1 hour). In the Fig. 11, it can see the torque control of the turbine is well proportional to the turbine power and the speed of PMSG follows well the reference speed imposed (Fig. 12).



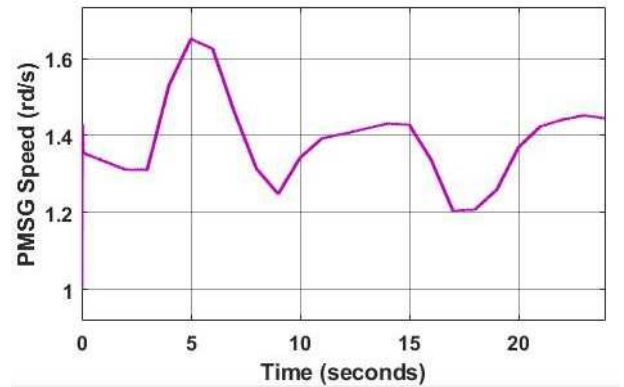
**Fig. 12** Current water profile

The DC bus voltage is controlled to avoid undesired effects on power electronics components. By acting on the current to be injected the reactive power into the network, control strategy is made PMSGP of both the DC bus voltage (Fig. 13). The simulation has successfully applied to the water profile for 1 month and 1 year for Firth number 7 in Orkney. While the time of simulation for 1 days took 26 minutes, the 1 month and 1 year data of current water velocity exceed 14 hours and 6 days, respectively.



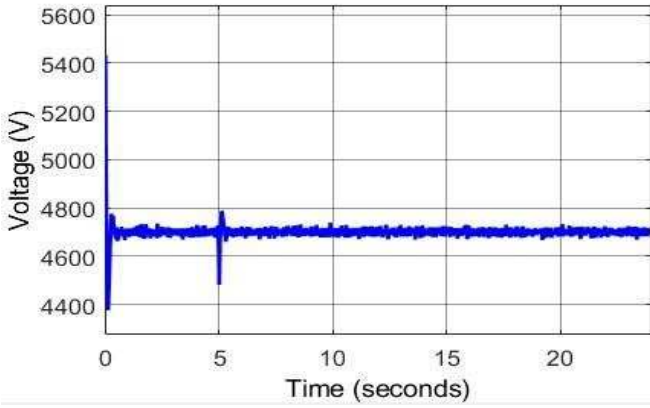
**Fig. 13** Turbine Torque

The results in Fig. 14 shows the capability of control technique to keep the speed of PMSG that drive by torque of tidal turbine within limited values. The voltage has been controlled to be in same limits for 1 year current water profile as shown in Fig. 15.



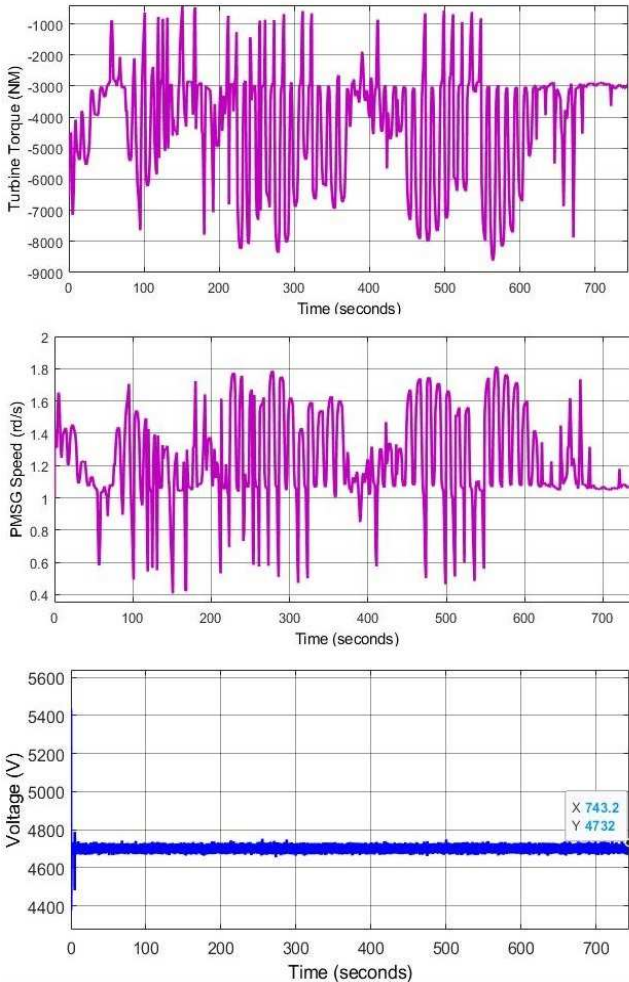


**Fig. 14** PMSG Speed Control



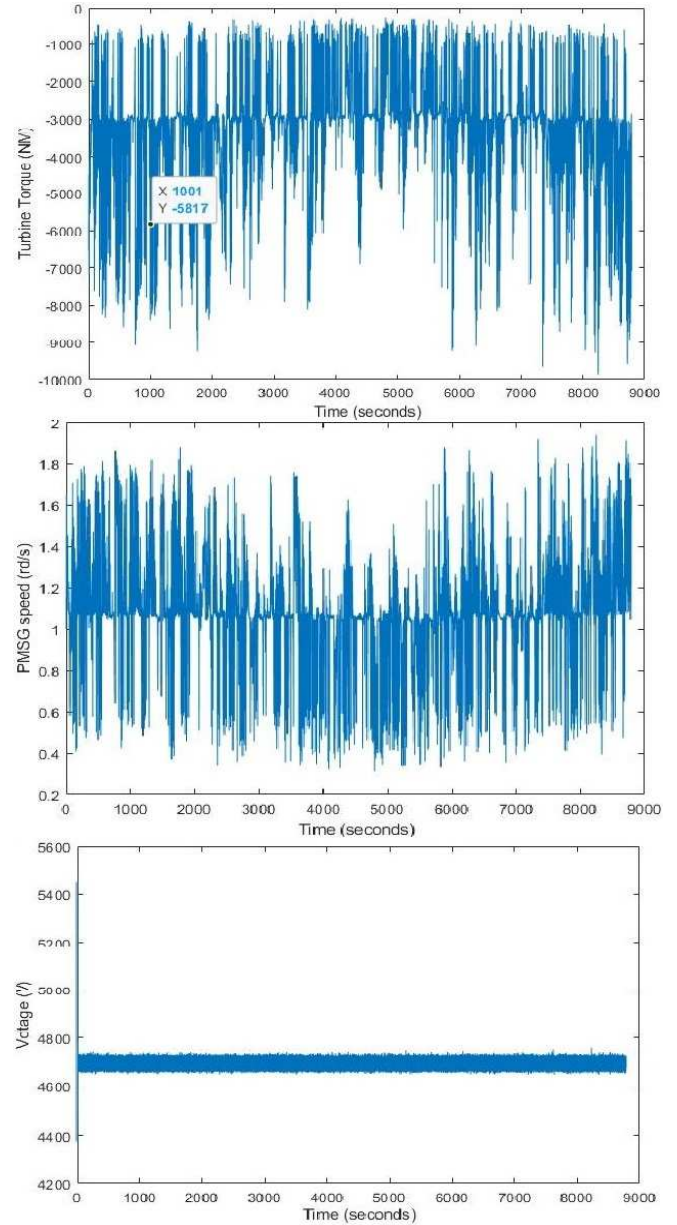
**Fig. 15** DC bus voltage

The high and low values of PMSG speed and Torque of tidal turbine has been increased and decreased not more than 15% than results for 1 month water profile. **The output voltage of DC bus is still in same required limit as shown in Fig. 16**



**Fig. 16** Results of EMR model for 1 month

**Fig. 17** shows that the average rate of water profile for 1 month and 1 year were 1.44 and 1.13, respectively. **The control of DC bus voltage has fluctuated within limited.** The EMR model has well adopted for Orkney system and the proposed control was follow the variation of water profile as shows in DC bus voltage figures. The control system and EMR model were efficient to keep the average values of system parameters not changes for all profiles (daily, monthly and yearly. This simulation has been implemented by Simulink/MATLAB environment under PC (Intel Xeon CPU 3.5 GHz, RAM 128 G, x64 bit, Windows 10).



**Fig. 17** Results of EMR model for 1 year

## 7. CONCLUSION

The tidal energy conversion system represents a complex multi-physics energetic system with multi variable produced by the interactions between its subsystems. In this study, a simulation was carried out using the Energy Macroscopic Representation (EMR) model which is developed for a case study (Orkney system). The data of velocity vector of tidal current around highly energetic location (Orkney Island) has been applied to the tidal system (Orbital O2) in this simulation. The EMR has also be used to represent the control of PMSG to operate at MPP and reactive power at DC bus. Different duration (daily, monthly and yearly) of current water profile for Orkney Island has been used to study the validation of the proposed control strategy. The results shows the ability of the proposed system to keep the variability of control parameters (the speed of the PMSG, DC bus voltage and the injected reactive power) within tolerable limits by using the deduced control technique. The results shows that the EMR was efficient to analyze and modelling the complex Orkney system and enables to design different control strategies under various operating modes of the system. Therefore, the proposed EMR model has the ability to adapt and develop more renewable sources such as the hydrogen electrolyzer in the future work.

## Acknowledgement

This work was supported by Integrating Tidal energy into the European Grid, which is funded by European Regional Development Fund. The project handles energy concerning carbon emissions in North West Europe (Orkney) and adopt technologies of low carbon such as tidal turbine, electrolyzer and Energy Management System. The ITEG project include the partners from across the UK, France, Belgium and the Netherlands.

## References

- [1] C. Nichita, M. Ashglaf, Y. Amara, and C. H. Jo, "Preliminary study of a concept of wind-tidal turbine coupling using functional similarities of real time emulation," *Renew. Energy Power Qual. J.*, vol. 17, pp. 371–376, 2019.
- [2] N. Khan, A. Kalair, N. Abas, and A. Haider, "Review of ocean tidal, wave and thermal energy technologies," *Renewable and Sustainable Energy Reviews*, vol. 72, pp. 590–604, 2017.
- [3] Y. S. Cho, J. W. Lee, and W. Jeong, "The construction of a tidal power plant at Sihwa Lake, Korea," *Energy Sources, Part A Recover. Util. Environ. Eff.*, vol. 34, no. 14, pp. 1280–1287, 2012.
- [4] S. Waters and G. Aggidis, "A world first: Swansea Bay tidal lagoon in review," *Renewable and Sustainable Energy Reviews*, vol. 56, pp. 916–921, 2016.
- [5] S. G. Longhitano, D. Mellere, R. J. Steel, and R. B. Ainsworth, "Tidal depositional systems in the rock record: A review and new insights," *Sedimentary Geology*, vol. 279, pp. 2–22, 2012.
- [6] S. Waters and G. Aggidis, "Tidal range technologies and state of the art in review," *Renewable and Sustainable Energy Reviews*, vol. 59, pp. 514–529, 2016.
- [7] A. Fernández-Jiménez, D. F. la Cruz, J. Ruiz-Torres, J. L. Perrino-Blanco, and R. Jimeno-Almeida, "Harnessing the Energy of Tidal Currents: State-of-the-Art and Proposal of Use in EV Charging Points," *Proceedings*, vol. 2, no. 23, p. 1504, 2018.
- [8] R. Loisel, M. Sanchez-Angulo, F. Schoefs, and A. Gaillard, "Integration of tidal range energy with undersea pumped storage," *Renew. Energy*, vol. 126, pp. 38–48, 2018.
- [9] S. Manchester, B. Barzegar, L. Swan, and D. Groulx, "Energy storage requirements for in-stream tidal generation on a limited capacity electricity grid," *Energy*, vol. 61, pp. 283–290, 2013.
- [10] Z. Zhou, F. Sculler, J. F. Charpentier, M. Benbouzid, and T. Tang, "Grid-connected marine current generation system power smoothing control using supercapacitors," in *IECON Proceedings (Industrial Electronics Conference)*, 2012, pp. 4035–4040.
- [11] A. Naderipour *et al.*, "Comparative evaluation of hybrid photovoltaic, wind, tidal and fuel cell clean system design for different regions with remote application considering cost," *J. Clean. Prod.*, vol. 283, 2021.
- [12] L. X. Zhang, S. J. Tang, Y. Hao, and M. Y. Pang, "Integrated energy and economic evaluation of a case tidal power plant in China," *J. Clean. Prod.*, vol. 182, pp. 38–45, 2018.
- [13] K. Chen, A. Bouscayrol, A. Berthon, P. Delarue, D. Hissel, and R. Trigui, "Global modeling of different vehicles," *IEEE Veh. Technol. Mag.*, vol. 4, no. 2, pp. 80–89, 2009.
- [14] A. Koita, A. Payman, B. Dakyo, and D. Hissel, "Control of a Wind Energy Conversion System using the Energetic Macroscopic Representation," in *7th International IEEE Conference on Renewable Energy Research and Applications, ICRERA 2018*, 2018, pp. 1460–1465.
- [15] D. S. Falcão and A. M. F. R. Pinto, "A review on PEM electrolyzer modelling: Guidelines for beginners," *Journal of Cleaner Production*, vol. 261, 2020.
- [16] Y. D. Wankam, P. Sicard, and A. Bouscayrol, "Maximum control structure of a five-drive paper system using energetic macroscopic representation," *IECON Proceedings (Industrial Electronics Conference)*, pp. 5332–5337, 2006.
- [17] K. S. Agbli, D. Hissel, M. Sorrentino, F. Chauvet, and J. Pouget, "Reverse engineering of a railcar prototype via energetic macroscopic representation approach," *Energy Convers. Manag.*, vol. 112, pp. 61–80, 2016.

- [18] L. Boulon, M. C. Péra, D. Hissel, A. Bouscayro, and P. Delarue, "Energetic macroscopic representation of a fuel cell-supercapacitor system," in *VPPC 2007 - Proceedings of the 2007 IEEE Vehicle Power and Propulsion Conference*, 2007, pp. 290–297.
- [19] K. S. Agbli, M. C. Péra, D. Hissel, O. Rallires, C. Turpin, and I. Doumbia, "Multiphysics simulation of a PEM electrolyser: Energetic Macroscopic Representation approach," *Int. J. Hydrogen Energy*, vol. 36, no. 2, pp. 1382–1398, 2011.
- [20] L. Gauchia, A. Bouscayrol, J. Sanz, R. Trigui, and P. Barrade, "Fuel cell, battery and supercapacitor hybrid system for electric vehicle: Modeling and control via energetic macroscopic representation," in *2011 IEEE Vehicle Power and Propulsion Conference, VPPC 2011*, 2011.
- [21] G. Lopez Lopez, R. Schacht Rodriguez, V. M. Alvarado, J. F. Gomez-Aguilar, J. E. Mota, and C. Sandoval, "Hybrid PEMFC-supercapacitor system: Modeling and energy management in energetic macroscopic representation," *Appl. Energy*, vol. 205, pp. 1478–1494, 2017.
- [22] M. Heidari, S. Wasterlain, P. Barrade, F. Gallaire, and A. Rufer, "Energetic Macroscopic Representation of a linear reciprocating compressor model," *Int. J. Refrig.*, vol. 52, pp. 83–92, 2015.
- [23] L. Horrein, A. Bouscayrol, Y. Cheng, and M. El Fassi, "Dynamical and quasi-static multi-physical models of a diesel internal combustion engine using Energetic Macroscopic Representation," *Energy Convers. Manag.*, vol. 91, pp. 280–291, 2015.
- [24] S. P. Neill *et al.*, "The wave and tidal resource of Scotland," *Renew. Energy*, vol. 114, pp. 3–17, 2017.
- [25] M. Lewis *et al.*, "Power variability of tidal-stream energy and implications for electricity supply," *Energy*, vol. 183, pp. 1061–1074, 2019.
- [26] A. Koita, A. Payman, M. B. Camara, B. Dakyo, and D. Hissel, "Hydrogen vector in the exploitation of a wind farm," in *2018 13th International Conference on Ecological Vehicles and Renewable Energies, EVER 2018*, 2018.