



HAL
open science

Kerosene flame behaviour of C/PEKK composite laminates: Influence of exposure time and laminates lay-up on residual mechanical properties

Benoît Vieille, Alexis Coppalle, L. Le Pluart, E. Schuhler, A. Chaudhary, B. Rijal, Adem Alia, Nicolas Delpouve

► To cite this version:

Benoît Vieille, Alexis Coppalle, L. Le Pluart, E. Schuhler, A. Chaudhary, et al.. Kerosene flame behaviour of C/PEKK composite laminates: Influence of exposure time and laminates lay-up on residual mechanical properties. *Composites Part B: Engineering*, 2021, 222, pp.109046. 10.1016/j.compositesb.2021.109046 . hal-03250836

HAL Id: hal-03250836

<https://normandie-univ.hal.science/hal-03250836v1>

Submitted on 13 Jun 2023

HAL is a multi-disciplinary open access archive for the deposit and dissemination of scientific research documents, whether they are published or not. The documents may come from teaching and research institutions in France or abroad, or from public or private research centers.

L'archive ouverte pluridisciplinaire **HAL**, est destinée au dépôt et à la diffusion de documents scientifiques de niveau recherche, publiés ou non, émanant des établissements d'enseignement et de recherche français ou étrangers, des laboratoires publics ou privés.



Distributed under a Creative Commons Attribution - NonCommercial 4.0 International License

Kerosene flame behaviour of C/PEKK composite laminates: influence of exposure time and laminates lay-up on residual mechanical properties

Vieille B.¹, Coppalle A.², Le Pluart L.³, Schuhler E.², Chaudhary A.², Rijal B.³, Alia A.¹, Delpouve N.¹

¹ Normandie Univ, UNIROUEN Normandie, INSA Rouen, CNRS, Groupe de Physique des Matériaux
76800 St Etienne du Rouvray

² Normandie Univ, UNIROUEN Normandie, INSA Rouen, CNRS, CORIA, 76800 St Etienne du Rouvray

³ Normandie Univ, ENSICAEN, UNICAEN, CNRS, Laboratoire de Chimie Moléculaire et
Thioorganique, 14000 Caen, France

Abstract

This work examines the influence of a kerosene flame on the residual mechanical tensile properties of composite laminates manufactured by thermo-consolidation process from unidirectional (UD) carbon fibers and a Polyether Ketone Ketone (PEKK) thermoplastic. Considering laminates with two stacking sequences (orthotropic or quasi-isotropic - QI), the influence of a kerosene flame exposure (116 kW/m² and 1100°C) on the composites structural integrity was examined as a function of exposure time (5-10-15min). The discussions on fire- and mechanically-induced damage mechanisms are supported by fractographic analysis of specimens. Not surprisingly, longer exposures to kerosene flame lead to gradually increasing damages within the laminates at different scales (micro-meso-macro), ultimately resulting in degrading the bearing capabilities of the material. With respect to virgin specimens, the axial strength decreases by almost 60 and 40% (after a 15min exposure) in orthotropic and QI laminates, respectively. At the same time, the axial stiffness is about 30 and 20% lower (after a 15min exposure). Contrary to orthotropic laminates, two well-defined areas are observed through the thickness in QI laminates: a severely degraded one and a virtually undamaged one. The first one corresponding to the exposed surface side is significantly damaged (fibers oxidation and pyrolysis of the PEKK matrix leading to an extensive delamination). The second one corresponding to the back-surface side is characterized by two plies with very little damage. When loaded in tension, the “undamaged” plies are characterized by the breakage of 0° fibers. This failure mechanism shows that these “undamaged” plies are capable to bear significant portions of the tensile loading contrary to orthotropic specimens in which extensive delamination prevails through the whole thickness.

Keywords: kerosene flame; thermoplastic laminates, mechanical testing, fractographic analysis

1. Introduction

The recent air disasters have revealed that the issue of fire is at the heart of the concerns of the aeronautics industry. The use of polymer matrix composite materials in aeronautic applications is today confronted with ever more demanding safety standards to which it is imperative to provide reliable and measurable answers [1-8]. Therefore, it is essential to enable manufacturers to

understand/predict the thermomechanical response of composite materials in different configurations of use and, ultimately, of their parts and assemblies. The demand for experimental characterization means representative of critical conditions in service is therefore strong from industrialists who have identified a technological barrier in the fire resistance of polymer matrix composite materials [9].

Thermosetting (TS) polymers have been the mainstays of aerospace composites since their introduction to aircraft [10]. Over the past thirty years, thermoplastics (TP) based composites represent a promising alternative in aeronautics. These qualities make TP polymers attractive as a matrix in fibers reinforced Polymer Matrix Composites (PMCs). The main drawback of high-performance thermoplastics (like PEEK, PEKK and PPS) concerns their processability that is more difficult than that of thermosetting composite systems [13]. Significant efforts have been devoted to developing melt-processable solutions and high compatibility with carbon fibers [14-15]. However, high-temperature resistance and impact toughness are the two most important technical requirements for practical applications of thermoplastic composites especially in aerospace [12][16]. TP composites are usually considered as secondary structural parts to replace TS composites in aeronautics [11-12].

Thermoplastics generally exhibit superior impact toughness, fire/smoke/toxicity (FST) performance and chemical resistance (with the exception of PEIs). For high-temperature applications, PPS, PEI and PEEK polymers also offer excellent thermal stability — a critical property in a number of military, aeroengine and prospective supersonic business jet programs where aerofrictional heating can generate continuous service temperatures beyond the capabilities of high-temperature epoxy thermosets [17].

Typically, the Airbus A350 engine mast consists of carbon reinforced PEEK laminates which may experience critical service conditions such as an aircraft engine fire. In this event, it is utmost important that the structural capabilities of the composite part are preserved for 15 min, as defined by the requirements of the Federal Aviation Regulations (FAR) standard FAA AC20-135 [18]. Aircraft-powerplant certification guidelines require large-scale fire tests to assess the ability of materials to act as firewalls. In their work, Chavez et al. developed a small-scale screening method [19]. Bare and protected carbon/epoxy specimens, with a configuration similar to components found in aircraft-powerplant firewalls, were exposed to an 1100 °C flame for 15 minutes, in accordance with service conditions met in aviation regulations. Thus, in order to test the fire resistance of PMCs, several standard tests specific to aeronautical applications are commonly used [20]. In particular, two different types of burner are described in the international standards for civil aircraft fire resistance [19-20], one type of burner using propane as fuel [8] and the other type using kerosene [21]. Chazelle et al. have compared the degradation induced by kerosene and propane flames providing the same heat flux (110kW/m²). They concluded that the mass loss rate is slower with the kerosene flame [22]. The maximum temperature value at the back surface is lower (about 150°C) compared to the value obtained with a propane flame. A high amount of soots is observed in the laminates exposed to a kerosene flame. It results in the formation of a char layer on the exposed surface which may contribute to reduce the heat transfer between the impinging flame and the specimen surface. Similarly, Le Neve

et al. have pointed out differences on the qualification results depending on the burner type [23]. Even though flame exposure presents multiple advantages, so far, most of the laboratory scale studies are performed with a cone calorimeter to apply a radiative heat flux on the sample [24]. However, a direct flame impact is a more realistic thermal stress [25-27] and heat flux greater than 100 kW/m^2 can be easily reached for many fire scenarios [28].

Ultimately, the present paper is not intended to give insight into the real-time fire performance and mechanical behavior of composites parts experiencing an aircraft engine fire. Instead, it provides information on the reaction-to-fire and the thermally-induced damages as well as on the post-fire tensile mechanical properties of TP-based laminates upon cooling after different kerosene flame exposure times. Therefore, it is not expected to be representative of a real fire scenario for which both thermal aggressions (from the kerosene flame) and mechanical loading are combined.

1.1 Polymer Matrix Composites (PMCs) under fire conditions

When composites are exposed to high temperatures, the organic matrices start to decompose with the release of heat, toxic gases and smoke [29-38]. Therefore, it is very important to understand the structural properties of TP-based composites under fire and to assess their residual mechanical properties. The combustion of polymeric-based materials is a complex process, involving many steps including some that are still unexplored [17]. They cannot be described quantitatively but can be described in a qualitative way. There are four primary stages: heating, decomposition, ignition and fire propagation. Heat diffuses deeply by conduction and generates physical and chemical transformations through-the-thickness [18]. The mesophase represents the area of the material where phase transitions and chemical reaction occur. In such mesophase, gas bubbles are formed within a condensed phase, the viscosity of which decreases as temperature increases. On the exposed surface, these bubbles burst and release combustible gases (pyrolysis gases) that will feed the flame. If any fractions of melt polymer remain ungasified, then they form viscous tar that accumulates on the exposed surface.

Most literature references are focused on the reaction-to-fire of thermosetting-based composites and the rapid heat-up on their thermal degradation [9][39]. More specifically, the influence of flame-retardants [40-41], laminates thickness [42], the reinforcement architecture [43], the orientation of carbon fibres on the reaction-to-fire characteristics of a layered composite [44-45] have been investigated in the literature. Many issues have been addressed including the health hazard of carbon fiber reinforced plastic material after a fire [46], the fire-performance and the residual mechanical properties. In the case of UD and quasi-isotropic laminates exposed to heat fluxes up to 80 kW/m^2 (resulting from a cone calorimeter), it appears that the temperature distribution through the laminate showed that the velocity and degree of combustion are dominated by fibre orientation for a given resin (TS - epoxy and TP – polyethersulfone) [42]. In general, a quasi-isotropic fibre orientation leads to faster ignition, because of preferred delaminations, but delays combustion processes more effectively than a unidirectional lay-up due to the voids created between the plies. Eibl and Swanson

have also concluded that the heat release during fire is greatly affected by the out-of-plane fiber angle because of the thermal boundaries created by the fibers [44]. Their results show a transverse shift in pyrolysis front velocity for increasing out-of-plane fiber angles. Pyrolysis pathways between the fiber boundaries facilitate faster combustion through the composite thickness, especially for increasing angles from 0° to 15°. Under chosen conditions, the pyrolysis front grows approximately 4 times faster when propagating along the fibers direction with respect to the perpendicular direction.

Most of the results available in the literature on the fire behavior of TP-based materials have been obtained from cone calorimeter thermal aggression [1-7][28], of a propane burner on polyphenylene sulfide composites [8], or of a kerosene burner on PolyEther–Ketone–Ketone (PEKK) composites [26-27]. Thermal degradation analysis based on TGA tests under inert and oxidative conditions have been conducted by Tadini et al. [47], then Grange et al. [48-51]. They concluded that PEKK-based composites have a higher thermal performance than phenolic-based composites. A NexGen burner designed by the Federal Aviation Administration (FAA) was used to get a standardised flame intended to be a realistic scenario of an in-service or post-impact fire event. Such device allows the investigations of the burn-through resistance and the thermal behaviour of C/PEKK laminates [26-27]. These references only focused on the thermal degradation but no significant attention was paid to the residual mechanical properties.

1.2 Post-fire residual mechanical properties

The effect of localised fire-induced damage on the residual tensile [45][52-54], compressive [55], flexural [56-57], shear [58-59] and impact [60] behaviour of fibre-reinforced polymer (FRP) composites has been investigated after thermal aggressions (cone calorimeter, laser irradiation) for different heat fluxes and exposure times. It is therefore possible to correlate the amount of the applied thermal energy with the heat damage and the residual mechanical properties. In the early eighties, a correlation between the degradation in residual mechanical properties, the calculated mass loss and the char layer thickness was proposed by Pering et al. [58]. A proportional relationship between the ultimate stress of the exposed sample and the non-charred thickness is found.

These works provide a deep insight into the damage development and the failure mechanisms of thermally degraded composites. The development of thermally induced cracks depends on the level of thermal degradation as well as the fibre orientation with respect to the applied load [45]. When it comes to thermoplastic-based composites, the thermally induced damages differ compared to the one observed in TS composites [1][42]. As was pointed out in [59], the epoxy resin is observed to degrade faster than the thermoplastic under thermal load, as measured by IR spectroscopy. It is therefore expected that the post-fire behaviour of TP-based laminates are different in term of properties reduction as well as from the mechanically induced damages [9][61]. TP composites generally have higher decomposition temperatures, yield high amounts of char, and are less susceptible to delamination cracking than TS laminates [1][3]. Char formation will influence the residual properties

of laminates, as it is known to retain the structural integrity of a fire-damaged composite by holding the fibers in place after the polymer matrix has been degraded [1]. In addition, melting and resolidification of the thermoplastic matrix positively affect the post-fire properties by maintaining the cohesion of the fibers network [2]. As a result, the analysis of the post fire tensile properties shows that prior severe fire exposures (medium to high heat flux – long exposure time) are more detrimental to C/Epoxy than to C/PPS laminates. At last, most references dealing with the post-fire mechanical properties of TP-based composites are focused on the influence of cone calorimeter heat fluxes (ranging from 20 to 60kW/m²). However, there are very few studies dealing with the influence of a kerosene flame exposure on the residual mechanical properties of PMCs [62]. While studying the tensile behaviour of quasi-isotropic carbon/epoxy laminates exposed to an 1100 °C methane flame and quenched at different intervals, Chavez et al. observed that the Ultimate Tensile Strength (UTS) reaches a plateau where loads could not be transferred between axial and transversal fibers due to matrix absence [19]. Thus, the residual UTS is solely attributed to the axially oriented fibers (0°) that bore the load until rupture. They also assessed the effectiveness of protective candidate materials by comparing the temperature distribution on the back surface and the UTS. Their results show a good correlation between temperature reduction and residual strength enhancement. In a study dealing with E-glass/vinyl ester (VE) laminates and E-glass/VE balsa core sandwich composites, Ulven et al. have observed the development of char through the thickness of the materials resulting from the decomposition of the polymer matrix [63]. The residual char is very porous, brittle, and that is detrimental to the structural integrity of the composite parts. Low velocity impact response of PMCs was found to decrease after fire exposure (80 kW/m², 800°C) even for short periods of time (<100 s).

1.3 Objectives of the work

Depending on the laminates lay-up (orthotropic or quasi-isotropic), the present work was aimed at investigating the influence of the kerosene flame exposure time (5-10-15min) on the fire behaviour and the residual tensile behaviour of C/PEKK composite laminates. These investigations focus on the effect of thermal degradation due to flame exposure on the composites structural integrity by comparing the changes of the tensile properties (axial stiffness and strength) with respect to the virgin materials. The discussions on fire- and mechanically-induced damage mechanisms are supported by fractographic analysis of specimens. The purpose of these investigations is threefold: (1) to understand how fire-induced damages change within the laminates micro- and meso-structures as a function of exposure time – (2) to quantify the residual mechanical properties of flame-exposed laminates – (3) to determine the role played by plies orientation on the fire behaviour as well as on the residual mechanical response.

2. Materials and laminates processing

2.1 Materials

2.1.1 Thermoplastic matrix

In this work, a Polyether Ketone Ketone (PEKK) polymer (Kepstan® 7003PT from ARKEMA) having density equal to 1,29 g/cm³ and average size 20µm powder as polymer matrix is chosen [64]. PEKK and PEEK are both in the polyaryletherketone family of ultra-high-performance polymers. The main advantage of using PEKK is due to its lower processing temperature than PEEK. However, the processing temperature of these polymers is different 350°C vs 380°C for PEEK. In particular, PEKK is well suited for the creation of large structural components. PEKK is a semi-crystalline thermoplastic with superior chemical and heat resistances and the ability to withstand high mechanical loads.

2.1.2 Carbon fiber (CF)

Polyacrylonitrile-based UD carbon fibers provided by Porcher Industry were used in the work. This carbon reinforcement is made of continuous yarns consisting of 12000 high strength filaments with a diameter of about 3mm as depicted in Figure 1. The density of carbon fiber is 1.5 g/cm³. Its tensile mechanical properties are a 270 GPa Young's modulus and a 700MPa tensile strength. Before processing, the carbon fibers were dried at 80°C for 24 hours in an oven.

2.2 Composite laminates processing

To fabricate the composite laminates, the polymer powder is combined with reinforcing fibers via the powder impregnating method. Powder impregnating method consists in associating reinforcing fibers with a polymer matrix powder. Heat is then applied on both sides by means of heating plates to melt the matrix and wet the fibers with the matrix (Figure 2). For this purpose, we used the thermo-compression molding technique to process carbon fibers reinforced PEKK laminates. PEKK powder and carbon fibers were placed layer by layer and the schematic view of the mold setup is shown in Figure 2. In this work, to keep constant the fiber volume fraction of composites plates, no additional polymer powder or no extra resin were pressed. The required amount of carbon fiber and matrix polymer weight in each compression molding run has been determined based on the pre-defined volume fraction and mold dimension. The fiber volume fraction is fixed to 0.5%. Then weight fraction of carbon fiber and matrix is calculated by using following relation:

$$W_f = \frac{\rho_f \times V_f}{\rho_f \times V_f + \rho_m (1 - V_f)}$$

Where, W_f = weight fraction of fiber

ρ_f = density of fiber

V_f = volume fraction of carbon fiber

ρ_m = density of matrix

Therefore, a weight fraction of fiber (0.537gm) and matrix (0.463gm) is obtained. Thus, for 1 gm of PEKK powder, it required 1.16 gm of carbon fiber. Before processing the composite laminates, all the samples were dried at different pre-drying temperatures as mentioned previously. The determination and optimization of the processing parameters is an empirical and time-consuming process, so an efficient and accurate study is needed to obtain the most accurate processing parameters. To prepare the plates, samples were molded at 350°C during 20-30 min without applying any pressure. After 30 min, a 68 bars pressure was applied at 350°C during 30 min then the sample was cooled down at room temperature. All the compressed molded plates were prepared in the size of 160 × 180mm panels with a nominal thickness of about 3.5 mm. For all the samples fabricated, the same molding temperature, molding time and pressure were used. Laminates plates with two different stacking sequences were processed in the present work: $[0]_8$ orthotropic (referred to as PUD) and $[0,+45,-45,90]_s$ quasi-isotropic plates (referred to as PQI). For both stacking sequences, a total number of 8 carbon fiber plies were used. The weight of the carbon fiber plies and PEKK on each molding run were 68.3gm and 58.8gm respectively. The total weight of PEKK powder were equally applied between each plies (lay-up) to fully wet out the fibers in each composites plate.

Tensile test specimens were cut by water jet from the different plates introduced previously after these plates were exposed to a kerosene flame. Three samples have been tested in the following configurations:

- As received after thermo-compression (referred to as virgin state),
- After a 5 min exposure to a kerosene flame (referred to as K5)
- After a 10 min exposure to a kerosene flame (referred to as K10)
- After a 15 min exposure to a kerosene flame (referred to as K15)

Finally, the prepared composites plates were then examined by using optical microscope to analyze for voids content (Figure 3). From microscopic analysis, it can be observed that a very good adhesion between carbon fiber and PEKK fabricated by compression molding techniques (as depicted in figure below). From these observations, one could confirm that there are no artifact as processed-induced porosities that may influence the reaction-to-fire and the mechanical properties of studied laminates.

3 Experimental set-up

3.1 Kerosene burner bench

The burner shown in Figure 3 is made with a domestic device (Cuenod manufacturer). The kerosene is injected in a nozzle generating a hollow cone spray with an angle equal to 80° and a maximum flow rate of 0.3 g/s. This flow rate is controlled with a mass flow meter (MINI CORI-FLOW™, Bronkhorst), and it can be adjusted. Airflow is also controlled with a mass flow meter (EL-FLOW® Prestige, Bronkhorst).

The air to fuel ratio has been selected at 0.85 of the stoichiometric value, in order to obtain heat flux and temperatures values close to the standard values (116 kW/m^2 and 1100°C) at the sample location. The flame at the exit of the turbulator is a wide and turbulent jet. Therefore, a 50 mm diameter steel tube is installed after the turbulator to channel the hot combustion gases on the exposed area of the sample. Details of the experimental set-up are presented in Figure 4. With this design, an efficient mixing occurs inside the first part of the flame tube, and in its remaining part, the flow turbulence is strongly damped. At the flame tube exit, no kerosene droplets are observed and the combustion is completed. Thus, the thermal stress on the sample is due to the hot gas mixture of the combustion products [65]. The flame tube diameter is chosen equal to the diameter of the sample exposed surface. Thus, the hot gas stream close to the sample wall corresponds to the stagnation zone of an impinging jet and the wall heat flux is nearly constant, as shown in a previous work on a propane burner [66].

The composite samples described in section 2.2 are placed on a dedicated sample holder for the test. The sample holder is presented in Figure 5. The composite sample is placed between two insulation layers and the assembly is clamped by two steel plates. On both sides of the sample holder, an 80 mm side square aperture is made. On the front side, the sample is facing the burner output. On the backside, the temperature measurement is performed. This sample holder has two major aims. The first one is to prevent the surrounding of the sample by the flame. The second one is to maintain the integrity of the sample border. This is of great interest to perform post-fire mechanical tests. The 80 mm square aperture is chosen in order to maintain a uniform heat flux on the exposed sample surface while maintaining at least 50 mm on the sample border.

3.2 Mechanical testing

Monotonic tensile tests were performed using a 100 kN capacity load cell of a MTS 810 servo-hydraulic testing machine in displacement-controlled mode at Room Temperature (RT). The tensile mechanical properties were determined according to the European standards EN 6035 [67].

3.3 Fractographic analysis

Microscopic observations have been carried out by means of a numerical optical microscope Keyence VHX-5000 to build 3D pictures of damaged areas.

4. Results and discussion

4.1 Influence of flame exposure time on the fire behaviour of orthotropic laminates

From the microscopic observations of orthotropic laminates, the main interest is to highlight the initial virgin state of the samples for comparison purposes after flame-exposure (Figure 6). They also allow distinguishing the orientation of carbon fibers within each ply of the orthotropic laminates (PUD).

After different exposure times to a kerosene flame (corresponding to a thermal aggression of 116 kW/m² and a surface temperature of about 600 °C), the macroscopic observations of orthotropic laminates (Figure 7) show that fire-degraded areas are similar on the exposed surfaces of laminates regardless the exposure time. It is primarily due to the sample holder shape that limits the degradation of the laminates to an 80mm side square. It is of the utmost importance noting that tensile specimens were cut in the plate after flame exposure. Of course, the thermal degradation induced by fire exposure depends on the location of these specimens on the plate. The most severely degraded ones are located in the central part of the plate. On the plate's edges (locations 1 and 5 in Figure 7), the tensile specimens look like they are in the virgin state. It is therefore expected that the residual tensile properties of the specimens are similar to the virgin state ones, whereas the decrease in the mechanical properties will be the most significant in the central area specimens.

To further investigate the influence of flame exposure time on the fire behaviour of PUD, microscopic observations were conducted on the tensile specimens cut from the plates exposed to a kerosene flame for 5-10-15min. These observations were performed on the specimen located at the centre of the fire-exposed plate (location 3 on Figure 7) to investigate the thermal degradation in the most severe situation. As expected, longer exposure times result in more severe thermal degradations on the exposed surfaces, though there are no significant differences through the thickness of the laminates. Figure 8 shows that the laminates are severely degraded for all testing conditions. Significant longitudinal splitting is observed as well as tar residue resulting from the thermal decomposition of the PEKK matrix on the exposed surface. Longer exposure times also result in complete pyrolysis of the PEKK matrix as a dry carbon fibers network clearly appears on the exposed surface. The observation of the back surface reveals that PEKK matrix started melting. Let us recall that the melting range is from 320 to 350 °C and the temperature of the melting peak is at 333°C. From the back surface observation, a few bubbles are clearly observed. It suggests that pyrolyzed gases tend to migrate from the inner plies to the back surface of the laminates. From the laminates edge observations, one can see that PEKK pyrolysis also leads to a significant delamination of the laminates plies although the damage on the back surface (on the left-hand side of Figure 8) is not significant for all exposure times. Only the outer ply (the one exposed to kerosene flame) is more severely degraded along with more pronounced PEKK pyrolysis and fibers oxidation. But the lower plies seemingly undergo the same thermal degradation.

In order to study the severity of thermal degradation, the residual mechanical tensile properties (axial stiffness and strength) were therefore evaluated as a function of flame exposure time. Depending on the location of the tensile specimen on the flame-exposed plate, the previous damages will go from the most severe thermal degradation (central location 3 on Figure 7) to virtually undamaged state along the plate edges (locations 1 and 5 on Figure 7). Before considering the influence of flame exposure time on the tensile residual behaviour of orthotropic laminates, let us examine now if the fire-behaviour of C/PEKK laminates depends on its stacking sequence, or not.

4.2 Influence of flame exposure time on the fire behaviour of quasi-isotropic laminates

As was considered in orthotropic laminates, the outer surfaces of quasi-isotropic laminates are used as a reference virgin state to analyse the influence of flame exposure time on the thermal degradation of the fire-exposed surface (Figure 9).

Unsurprisingly, the observations of PQI specimens exposed surfaces clearly show that a longer exposure time to kerosene flame leads to a complete pyrolysis of the outer ply (associated with the oxidation of carbon fibers and thermal decomposition of PEKK matrix) ultimately revealing dry +/- 45° oriented plies underneath (Figure 10). However, there are no significant differences observed on the back surface, suggesting that they are similarly thermally-degraded. These thermal degradation mechanisms are confirmed by the microscopic observations of PQI specimens (Figure 11).

From the comparison of macroscopic observations of the exposed and back surfaces of laminates with orthotropic (Figure 7) and quasi-isotropic (Figure 10) lay-ups, it appears that the stacking sequence does not seem to significantly change the fire behaviour of C/PEKK laminates. This needs to be further investigated by the comparison of microscopic observations of orthotropic (Figure 8) and PQI (Figure 11) specimens taken from the central location in the fire-exposed plate.

All PQI specimens are characterized by significant damages that can be observed on the exposed surface (Figure 11). A network of transverse micro-cracks is formed along with tar (residue of PEKK thermal decomposition at temperatures higher than 600°C) during fire-exposure. On the back surface, the PEKK colour turned transparent as already observed in PUD specimens. Contrary to PUD composites, the observations of laminates edge shows two well-defined areas through the thickness: a severely degraded one and a virtually undamaged one. The first one corresponding to the exposed surface is significantly damaged because of the fibres oxidation and the pyrolysis of the PEKK matrix leading to an extensive delamination. The second one corresponding to the back surface is characterized by two plies with no significant damage. In addition, there is no transition zone between these two areas suggesting that the extensively delaminated +/-45° plies possibly contribute to the protection of the plies underneath by creating insulating layers. This could explain why the outer plies of the PQI laminates are virtually “undamaged”. Ultimately, it is expected that the residual tensile response (and corresponding properties) of these specimens will significantly depend on these undamaged plies as the cohesion of both matrix and fibers network is relatively well preserved in these plies. In other words, the preservation of the mechanical properties in tension (with respect to virgin specimens) should be better with PQI laminates than with PUD composites.

4.3 Influence of flame exposure time on the tensile behaviour of orthotropic laminates (PUD)

In the previous section, large plates (180*160mm²) of C/PEKK laminates were exposed to a kerosene flame whose diameter is about 50mm. These fire exposure tests are expected to be representative of a fire scenario and these fire conditions lead to a heterogeneous temperature distribution on the exposed surface as well as through the thickness. As was observed in Figure 10, tensile specimens are directly

cut by waterjet from these flame-exposed plates. These tensile specimens are more or less thermally-degraded depending on their location on the plates. As a result, a gradual decrease in the residual tensile properties should be observed from the specimens located along the edges (locations 1 and 5) to the specimens located in the more severely degraded area of the plate (locations 2-3-4). The tensile mechanical responses of these different specimens is elastic quasi-brittle. It is consistent as the mechanical behaviour of $[0]_8$ laminates is driven by the tensile behaviour of 0° fibres. For comparison purposes, the representative responses of virgin specimens are represented to illustrate the severity of flame-exposure depending on the fire exposure time (Figure 12).

When comparing the mechanical properties (axial stiffness and strength) of PUD in the virgin state and after different exposure times (central specimen of the fire-exposed plate), the axial strength decreases by almost 60% (after a 15min exposure) whereas the axial stiffness is about 30% lower (Figure 13).

In the specimens located far from the kerosene flame (locations 1 and 5), the preservation of tensile properties (stiffness and strength) is good with very little decrease (about -5% and -15%, respectively). Figure 14 also clearly shows that the kerosene flame leads to significant gradients in mechanical properties, with a dramatic decrease in the tensile properties in central specimens of the fire-exposed plates. The evolution is similar regardless the exposure time.

In orthotropic laminates exposed to a kerosene flame, it appears that the structural capabilities of C/PEKK have significantly decreased in the most detrimental conditions (specimen taken from location 3 – Figure 13). When it comes to qualify PMCs parts for applications in aeronautics, these tests provide inputs to be used in design rules. Finally, Figure 13 also indicates that once the laminates are thermally-degraded in the central area of the plate, exposure time seems to have limited or barely significant influence on the evolution of the axial strength and stiffness, respectively. These observations can be discussed along with the fire-induced damages observed in Figure 8. Indeed, for all exposure times, from the laminates edge observations, significant delamination is observed whereas the damage on the back surface is not significant in PUD specimens before they are subjected to tensile loadings.

To further explain the evolution of the tensile properties with exposure time, front/back surfaces as well as the laminates edges were observed (Figure 15). It was chosen here to consider only the fractographic analysis of the most severely degraded specimens (central specimen of the fire-exposed plate) to observe the consequences of the most critical service conditions.

On the one hand, the comparison with specimens subjected to a tensile loading without prior flame exposure is relevant as it emphasizes the specific damage mechanisms resulting from fire exposure. On the outer plies of virgin specimens, longitudinal splitting as well as carbon fibers breakage are observed, whereas the macroscopic observations of laminates edges show an extensive delamination. With respect to virgin specimens loaded in tension, the delamination initially induced by thermal

decomposition in specimens exposed to a kerosene flame significantly grows when the tensile loading is applied due to the propagation of interlaminar cracks.

On the other hand, let us recall the damages caused by flame-exposure in PUD specimens (Figure 8). The thermally-induced damages primarily consisted of delamination coming along with PEKK matrix pyrolysis, which were expected to significantly influence the mechanical behaviour and fracture mechanisms. After tensile testing, the exposed surface of the laminates is severely degraded. Char (carbonaceous residue resulting from both PEKK matrix and carbon fibres thermal decomposition) facilitates longitudinal splitting and ultimately the breakage of fibres in tension (Figure 15). The axial stiffness of specimens in tension is primarily associated with the stiffness of carbon fibers. The oxidation of carbon fibres is limited to the exposed surface as the plies underneath are protected by the formation of a char layer on the outer ply [16]. Thus, the axial stiffness is not much affected by kerosene flame aggression. However, the extensive delamination of C/PEKK laminates (coming along with the PEKK matrix pyrolysis) alters significantly the load transfer between the laminates plies. This is detrimental from the strength standpoint as each ply bears a portion of the tensile loading and once a ply fails, the mechanical load is not taken up by the neighbouring plies.

4.4 Influence of flame exposure time on the tensile behaviour of quasi-isotropic laminates (PQI)

The tensile mechanical responses of all specimens are elastic-brittle though there are only two plies oriented at 0° (the outer ones). For comparison purposes, the representative responses of virgin specimens are represented to illustrate the severity of flame-exposure depending on the flame exposure time (Figure 16). When comparing the mechanical properties (axial stiffness and strength) of PQI laminates in the virgin state and after different exposure times, the axial strength decreases by almost 40% (after a 15min exposure) whereas the axial stiffness is about 20% lower in central specimens of the fire-exposed plates (Figure 17). It is also worth noting that the decrease in the tensile properties due to flame exposure is therefore less dramatic than the one observed in PUD specimens. Indeed, for the latter, the axial strength decreased by almost 60% (after a 15min exposure) whereas the axial stiffness was about 30% lower with respect to the virgin PUD. In specimens located far from the kerosene flame (locations 1 and 5), it appears that the structural capabilities of C/PEKK are rather well maintained even in the most detrimental conditions (specimen taken from position 3). Indeed, the axial stiffness only decreases by 7%, whereas there is a moderate decrease (-18%) in axial strength with respect to the virgin state (Figure 18).

4.5 Influence of stacking sequence on the fire and post-residual mechanical performance

The previous results clearly show that the laminates stacking sequence influences the reaction-to-fire and the residual mechanical properties of C/PEKK laminates. From literature, it clearly appears that the onset and propagation of cracks depend on the level of thermal degradation and the fibre orientation with respect to applied load. With increasing thermal degradation, the prominent failure

mechanism (transverse matrix cracking) is replaced by crack initiation and propagation in the damaged outermost ply regardless its fibre orientation [35][42]. From the residual mechanical properties standpoint, strength and stiffness reduction can be observed even without flame combustion when the mechanical behaviour is matrix-dominated [35]. With increasing thermal degradation of the polymer matrix, the onset of crack initiation and propagation is shifted to lower strains [42]. In quasi-isotropic laminates whose mechanical behavior is fibers dominated, a very little decrease in mechanical properties is observed before ignition and the properties reduction accelerates after ignition. To further explain the changes in the tensile properties of PQI and PUD laminates with exposure time, front/back surfaces as well as the laminates edges were observed. Similarly to orthotropic laminates (section 4.3), it was chosen here to consider only the fractographic analysis of the most severely degraded specimens (central location of the flame-exposed plate) to observe the consequences of the most critical service conditions (Figures 15 and 19). Virgin specimens are characterized by the breakage of 0° oriented carbon fibres on the outer plies and extensive delamination. As was observed in orthotropic specimens, specimens are severely degraded on the exposed surface. Char facilitates transverse cracking and ultimately the breakage of 0° carbon fibres. Bubbles of pyrolyzed matrix coming along tar formation are observed. The observations of edges reveal that flame-exposed specimens experience mostly delamination. However, delamination is less extensive in PQI compared to PUD. This may stem from the better contribution of “undamaged” plies (after thermal aggression) to the tensile response.

The differences observed in the residual tensile properties of PQI and PUD laminates possibly arises from the differences observed in thermally-induced damages. It is assumed that the extensively delaminated $\pm 45^\circ$ plies may contribute to the protection of the plies underneath by creating insulating layers. It therefore explains why the outer plies of the PQI are virtually undamaged, hence maintaining a good cohesion of both matrix and fibres network. Ultimately, the relatively good preservation of residual tensile properties of PQI specimens exposed to a kerosene flame significantly depends on the thickness of these “undamaged” plies. When loaded in tension, these plies are characterized by the breakage of 0° fibres. This failure mechanism shows that these “undamaged” plies are capable of bearing significant portions of the tensile loading contrary to orthotropic specimens in which extensive delamination prevails through the whole thickness. Consequently, delamination being more critical from the composites structural integrity standpoint, the preservation of tensile properties of orthotropic specimens exposed to fire is not as good as the one of QI laminates.

5. Conclusions

The objective of the present work was threefold: (1) to investigate the influence of kerosene flame exposure time (thermal aggression of 116 kW/m² and 1100°C for 5-10-15min) on the fire-induced damages within thermoplastic-based composites laminates – (2) to evaluate the residual mechanical behaviour of laminates with different lay-ups (orthotropic or quasi-isotropic) – (3) to determine the role played by plies orientation on the fire behaviour as well as on the residual mechanical response.

Unsurprisingly, longer exposures to kerosene flame cause significant damages within the laminates at different scales (micro-meso-macro) ultimately resulting in degrading the bearing capabilities of the material. In orthotropic laminates, the axial strength decreases by almost 60% (after a 15min exposure) whereas the axial stiffness is about 30% lower with respect to the virgin specimens. In quasi-isotropic laminates, the axial strength decreases by almost 40% (after a 15min exposure) whereas the axial stiffness is about 20% lower with respect to the virgin specimens.

Thus, the decrease in the tensile properties due to kerosene flame exposure is therefore less dramatic in quasi-isotropic laminates than it is in orthotropic laminates. This evolution stems from the differences observed in thermally induced damages. Contrary to orthotropic laminates, two well-defined areas are observed through the thickness in QI laminates: a severely degraded one and a virtually undamaged one. The first one corresponds to the exposed surface and is significantly damaged (fibres oxidation and pyrolysis of the PEKK matrix leading to an extensive delamination). The second one corresponds to the back side is characterized by two plies with no significant damage. It is assumed that the extensively delaminated +/-45° plies may contribute to the protection of the plies underneath by creating insulating layers. It therefore explains why the outer plies of the QI laminates are virtually undamaged, hence maintaining a good cohesion of both matrix and fibres network. When loaded in tension, the “undamaged plies” are characterized by the breakage of 0° fibers. This failure mechanism shows that these “undamaged” plies are capable to bear significant portions of the tensile load contrary to orthotropic specimens in which extensive delamination prevails through the whole thickness. Consequently, delamination being more critical from the composites structural integrity standpoint, the preservation of tensile properties of orthotropic specimens exposed to fire is not as good as the one of QI laminates.

From the present work, it is therefore possible to better understand how the fire-induced damages within the laminates micro- and meso-structures modify the mechanical behavior of thermoplastic-based composite laminates to be used in aeronautics.

Acknowledgements

The work presented in this study is the result of the RIN (Réseau d'Intérêt Normand) project AEROFLAMME (Behaviour of **AERON**autical Composites under **FLAM**me and **ME**chanical Loading) financed by the Normandy Region and the FEDER (European Regional Development Fund). L. Le Pluart also thanks the french MESRI, Normandie Université, UNICAEN, ENSICAEN, CNRS, INC3M Research Federation, ANR, FEDER, Normandy Region, LabEx EMC3 (ANR-10-LABX-09-01) and LabEx Synorg (ANR-11-LABX-0029) for supporting his research activities.

References

- [1] Vieille B., Lefevbre C., Coppalle A., Post fire behavior of carbon fibers thermoplastic- and thermosetting-based laminates for aeronautical applications: a comparative study. *Materials and Design*, 63, pp. 56-68, 2013.
- [2] Vieille B., Coppalle A., Keller C., Garda M-R., Viel Q., Dargent E. Correlation between post fire behavior and microstructure degradation of aeronautical polymer composites. *Materials and Design*, 74, pp. 76-85. 2015.
- [3] Carpier Y., Vieille B., Coppalle A., Barbe F. About the tensile mechanical behaviour of carbon fibres fabrics reinforced thermoplastic composites under very high temperature conditions. *Composites Part B*, doi: 10.1016/j.compositesb.2019.107586, 2019.
- [4] Carpier Y., Vieille B., Delpouve N., Dargent E. Isothermal and anisothermal decomposition of Carbon fibres polyphenylene sulfide composites for fire behavior analysis. *Fire Safety Journal*, 109: 102868, 2019.
- [5] Carpier Y., Vieille B., Maaroufi M.A., Coppalle A., Barbe F. Mechanical behavior of carbon fibers polyphenylene sulfide composites exposed to radiant heat flux and constant compressive force. *Composite Structures*, 200, pp. 1-11, 2018.
- [6] Maaroufi M.A., Carpier Y., Vieille B., Gilles L., Coppalle A., Barbe F. Post-fire compressive behaviour of carbon fibers woven-ply Polyphenylene Sulfide laminates for aeronautical applications. *Composites Part B*, 119, pp. 101-113, 2017.
- [7] Vieille B., Coppalle A., Carpier Y., Maaroufi M.A., Barbe F. Influence of the matrix chemical nature on the post-fire mechanical behavior of notched polymer-based composite structures for high temperature applications. *Composites Part B*, 100, pp. 114-124, 2016.
- [8] Schuhler E., Coppalle A., Vieille B., Yon J., Carpier Y. Behaviour of aeronautical polymer composite to flame: A comparative study of thermoset- and thermoplastic-based laminate. *Polymer Degradation and Stability*, 152, pp. 105-115, 2018.
- [9] A.P. Mouritz, A.G. Gibson, *Fire Properties of Polymer Composite Materials*. Solid Mechanics and its Applications, Springer, Dordrecht, 2006.

- [10] L. Zhu, N. Li, P.R.N. Childs. Light-weighting in aerospace component and system design. *Propuls. Power Res.* 7, 103–119 (2018).
- [11] A. Saleem, L. Frommann, A. Iqbal. High performance thermoplastic composites: Study on the mechanical, thermal, and electrical resistivity properties of carbon fiber-reinforced polyetheretherketone and polyethersulphone. *Polym. Compos.* 28: 785–796 (2007).
- [12] Vieille B., Albouy W., Chevalier L., Taleb L. About the influence of stamping on thermoplastic-based composites for aeronautical applications. *Compos. Part B Eng.* 45: 821–834 (2013).
- [13] Fujihara, K., Huang, Z.-M., Ramakrishna, S. & Hamada, H. Influence of processing conditions on bending property of continuous carbon fiber reinforced PEEK composites. *Compos. Sci. Technol.* 64, 2525–2534 (2004).
- [14] C. Lu, N. Xu, T. Zheng, X. Zhang, H. Lv, X. Lu, L. Xiao, D. Zhang. The optimization of process parameters and characterization of high-performance CF/PEEK composites prepared by flexible CF/PEEK plain weave fabrics. *Polymers* 11, (2018).
- [15] Chen J., Wang K., Dong A., Li X., Fan X., Zhao F. A comprehensive study on controlling the porosity of CCF300/PEEK composites by optimizing the impregnation parameters. Volume 39, Issue 10, October 2018, 3765-3779.
- [16] Vodermayr A.M., Kaerger J. C., Hinrichsen G. Manufacture of high performance fibre-reinforced thermoplastics by aqueous powder impregnation. *Compos. Manuf.* 4, 123–132 (1993).
- [17] C. Red. Thermoplastics in Aerospace Composites Outlook, 2014-2023; *Composites World*, January 2014.
- [18] Federal Aviation Regulations (FAR) standard FAA AC20-135. Powerplant Installation and Propulsion System Component Fire Protection Test Methods, Standards and Criteria with change; February 1990.
- [19] P. Chávez Gómez, T. Pelzmann, E. Robert, L.L. Lebel. Evaluation of the fire resistance of protected carbon/epoxy laminates in small-scale experiments. AIAA Scitech 2019 Forum, 7-11 January 2019, San Diego, California.
- [20] Standard method ISO 2685, “Resistance to fire in designated fire zones,” 1998.
- [21] P. Tranchard, F. Samyn, S. Duquesne, M. Thomas, B. Estèbe, J-L. Montès, S. Bourbigot. Fire behaviour of carbon fibre epoxy composite for aircraft: Novel test bench and experimental study. *Journal of Fire Sciences*, vol. 33, no. 3, pp. 247–266, 2015.
- [22] T. Chazelle, A. Perrier, E. Schuhler, G. Cabot, A. Coppalle. Fire response of a carbon epoxy composite - comparison of the degradation provided with kerosene or propane flames.
- [23] S. LeNeve. AC 20-135 / ISO 2685 Fire tests on components used in fire zones. Comparison of gas burner to oil burner. International Aircraft Materials Fire Test WG, Atlantic City, 2008.
- [24] S. I. Stoliarov, S. Crowley, R. E. Lyon, G. T. Linteris. Prediction of the burning rates of non-charring polymers. *Combustion and Flame*, vol. 156, no. 5, pp. 1068–1083, 2009.

- [25] N. Grange, B. Manescau, K. Chetehouna, N. Gascoïn. Fire resistance of carbon-based composite materials under both ideal and realistic normative configurations. *Applied Thermal Engineering* 159 (2019) 113834.
- [26] Gascoïn N. Experimental study of the burn-through resistance of aeronautical polymer composite materials in case of fire event. 14th International Conference and Exhibition on Fire Science and Engineering, Royal Holloway College, UK, 4-6 July 2016.
- [27] S. Timme, V. Trappe, M. Korzen, B. Schartel. Fire stability of carbon fiber reinforced polymer shells on the intermediate-scale. *Composite Structures*, Volume 178, 2017, Pages 320-329.
- [28] Y.M. Ghazzawi, A.F. Osorio, M.T. Heitzmann. The effect of fibre length and fibre type on the fire performance of thermoplastic composites: The behaviour of polycarbonate as an example of a charring matrix. *Construction and Building Materials*, 234, 2020.
- [29] Y. Hou, Z. Xu, F. Chu, Z. Gui, L. Song, Y. Hu, W. Hu. A review on metal-organic hybrids as flame retardants for enhancing fire safety of polymer composites. *Composites Part B*, 2021, 109014.
- [30] A.C.Y. Yuen, T.B.Y. Chen, C. Wang, W. Wei, I. Kabir, J.B. Vargas, Q.N. Chan, S. Kook, G.H. Yeoh. Utilising genetic algorithm to optimise pyrolysis kinetics for fire modelling and characterisation of chitosan/graphene oxide polyurethane composites. *Composites Part B*, 182, 2020, 107619.
- [31] B.K. Kandola, L. Krishnan, J.R. Ebdon, P. Myler. Structure-property relationships in structural glass fibre reinforced composites from unsaturated polyester and inherently fire-retardant phenolic resin matrix blends. *Composites Part B*, 182, 2020, 107607.
- [32] Y. Zhang, J.W. Ju, Q. Chen, Z. Yan, H. Zhu, Z. Jiang. Characterizing and analyzing the residual interfacial behavior of steel fibers embedded into cement-based matrices after exposure to high temperatures. *Composites Part B*, 191, 2020, 107933.
- [33] P. S. Carneiro Vieira, F. Soutilha de Souza, D.C. Taisum Cardoso, J. Domingos Vieira, F. de Andrade Silva. Influence of moderate/high temperatures on the residual flexural behavior of pultruded GFRP. *Composites Part B*, 200, 2020, 108335.
- [34] S. Araby, B. Philips, Q. Meng, J. Ma, T. Laoui, C. H. Wang. Recent advances in carbon-based nanomaterials for flame retardant polymers and composites. *Composites Part B*, 212, 2021, 108675.
- [35] Y-F. Ai, L. Xia, F-Q. Pang, Y-L. Xu, H-B. Zhao, R-K. Jian. Mechanically strong and flame-retardant epoxy resins with anti-corrosion performance. *Composites Part B*, 193, 2020, 108019.
- [36] J. Chen, J. Wang, A. Ding, A. Ni, H. Chen. Flame retardancy and mechanical properties of glass fibre reinforced polyethylene composites filled with novel intumescent flame retardant. *Composites Part B*, 179, 2019, 107555.
- [37] Y. Qiu, L. Qian, Y. Chen, J. Hao. Improving the fracture toughness and flame-retardant properties of epoxy thermosets by phosphaphenanthrene/siloxane cluster-like molecules with multiple reactive groups. *Composites Part B*, 178, 2019, 107481.
- [38] M. Grasso, Y. Xu, A. Ramji, G. Zhou, A. Chrysanthou, G. Haritos, Y. Chen. Low-velocity impact behaviour of woven laminate plates with fire retardant resin. *Composites Part B*, 171, 2019: 1-8.

- [39] Z. Yu, A. Zhou. Effect of flame heat flux on thermal response and fire properties of char-forming composite materials. *Fire and Materials* 2012; 38(1).
- [40] L. Greiner, M. Doring, S. Eibl. Prevention of the formation of respirable fibers in carbon fiber reinforced epoxy resins during combustion by phosphorus or silicon containing flame retardants" *Polym. Degrad. Stab.* 2021; 185, 109497.
- [41] S. Eibl. Reaction-to-fire properties of polymer matrix composites with integrated intumescent barriers. *Fire Materials* 2015; 39, 658-674.
- [42] S. Eibl. Influence of carbon fibre orientation on reaction-to-fire properties of polymer matrix composites. *Fire Materials* 2012; 36:309–324.
- [43] S. Eibl. Influence of unwoven roving and woven fabric carbon fiber reinforcements on reaction-to-fire properties of polymer matrix composites. *Fire and Materials* 2020; 44, 557-572. ^
- [44] S. Eibl, D. Swanson. Influence of out-of-plane fiber orientation on the reaction-to-fire properties of carbon fiber reinforced polymer matrix composites. *Fire Materials* 2018; 42, 234-243.
- [45] T.H.Y. Quach, A. Benelfellah, B. Batiot, D. Halm, T. Rogaume, J. Luche, D. Bertheau. Determination of the tensile residual properties of a wound carbon/epoxy composite first exposed to fire. *Journal of Composite Materials* 2017; 51(1):17-29.
- [46] S. Eibl. Potential for the formation of respirable fibers in carbon fiber reinforced plastic materials after combustion. *Fire Materials* 2017; 41, 808-816.
- [47] P. Tadini, N. Grange, K. Chetehouna, N. Gascoin, S. Senave, I. Reynaud. Thermal degradation analysis of innovative PEKK-based carbon composites for high-temperature aeronautical components. *Aerospace Science and Technology*, Volume 65, 2017: 106-116.
- [48] N. Grange, P. Tadini, K. Chetehouna, N. Gascoin, I. Reynaud, S. Senave. Determination of thermophysical properties for carbon-reinforced polymer-based composites up to 1000°C. *Thermochemica Acta*, Volume 659, 2018: 157-165.
- [49] N. Grange, P. Tadini, K. Chetehouna, N. Gascoin, I. Reynaud, G. Bouchez, S. Senave, I. Reynaud. Experimental determination of fire degradation kinetic for an aeronautical polymer composite material. *International Journal of Structural Integrity*, <https://doi.org/10.1108/IJSI-03-2017-0021>.
- [50] K. Chetehouna, N. Grange, N. Gascoin, L. Lemée, I. Reynaud, S. Senave. Release and flammability evaluation of pyrolysis gases from carbon-based composite materials undergoing fire conditions, *Journal of Analytical and Applied Pyrolysis*, Volume 134, 2018: 136-142.
- [51] N. Grange, K. Chetehouna, N. Gascoin, S. Senave. Numerical investigation of the heat transfer in an aeronautical composite material under fire stress, *Fire Safety Journal*, Volume 80, 2016: 56-63.
- [52] J. Wolfrum, E. Quan, G. Maier, S. Eibl. Damage initiation of thermally degraded carbon composites in tension. *Journal of Composite Materials* 2018; 52(24):3399-3409.
- [53] T. Bhat, E. Kandare, A.G. Gibson, P. Di Modica, A.P. Mouritz. Tensile properties of plant fibre-polymer composites in fire. *Fire and Materials* 2017; 41(8).

- [54] S. Feih, A.P. Mouritz. Tensile properties of carbon fibres and carbon fibre polymer composites in fire. *Compos Part A* 2012; 43: 765-772.
- [55] Gardiner, C.P., Mathys, Z., Mouritz, A.P. Tensile and Compressive Properties of FRP Composites with Localised Fire Damage. *Applied Composite Materials* 9, 353–367 (2002).
- [56] A.P. Mouritz, Z. Mathys. Mechanical properties of fire-damaged glass-reinforced phenolic composites. *Fire and Materials* 2000; 24(2).
- [57] F. Lacroix, V. Allheily, K. Diener, A. Eichhorn, M. Gillet, G. L'Hostis. Thermomechanical behavior of aeronautic structural carbon epoxy composite submitted to a laser irradiation. *Composite Structures* 2016; 143: 220-229.
- [58] Pering GA, Farrell PV and Springer GS. Degradation of tensile and shear properties of composite exposed to fire or high temperature. *J Compos Mater* 1980; 14: 54–68.
- [59] Wolfrum J, Whitney E, Eibl S. Approaches to understand and predict the influence of rapid heat-up on degradation and strength of carbon fibre polymer matrix composites. *Journal of Composite Materials*. 2017; 51(17):2435-2447.
- [60] S-G. Hong, S-Y. Chang. Fire performance and mechanical properties of acrylonitrile-butadiene-styrene copolymer/modified expandable graphite composites. *Fire and Materials* 2011, 6(4).
- [61] A.G. Gibson, M.E.O. Torres, T.N.A. Browne, S. Feih, A.P. Mouritz. High temperature and fire behaviour of continuous glass fibre/polypropylene laminates. *Composites Part A* 2010; 41(9): 1219–1231.
- [62] A. Hörold, B. Schartel, V. Trappe, M. Korzen, J. Bünker. Fire stability of glass-fibre sandwich panels: The influence of core materials and flame-retardants, *Composite Structures*, Volume 160, 2017.
- [63] C.A. Ulven, U.K. Vaidy. Impact response of fire damaged polymer-based composite materials. *Composites Part B* ; 39 : 92–107 (2008).
- [64] Kepstan® PEKK Polymer Range. <https://www.extremematerials-arkema.com/en/product-families/kepstan-pek-polymer-range/>.
- [65] A. Petit, B. Vieille, A. Coppalle, F. Barbe, M.-A. Maaroufi. High temperature behaviour of PPS-based composites for aeronautical applications: Influence of fire exposure on tensile and compressive behaviors. 20th International Conference on Composite Materials (ICCM20), Copenhagen, 19-24 July 2015.
- [66] E. Schuhler, B. Lecordier, J. Yon, G. Godard, and A. Coppalle, “Experimental investigation of a low Reynolds number flame jet impinging flat plates,” *International Journal of Heat and Mass Transfer*, vol. 156, p. 119856, 2020.
- [67] Test standard EN 6035, aerospace series - fiber-reinforced plastics - test method - determination of notched and unnotched tensile strength; Published by the European association of aerospace industries (AECMA), 1996.

Figure captions

Fig. 1 – Unidirectional carbon fiber used in this work.

Fig. 2 – Schematic of tool assembly as used for fabrication of composite laminates

Fig. 3 – Optical microscopy images of transverse cross sections in C/PEKK laminates: (a) orthotropic - (b) quasi-isotropic

Fig. 4 – Kerosene flame exposure: (a) Experimental set-up - (b) Scheme of the laboratory scale burner

Fig. 5 – Observations of the sample holder on the kerosene flame exposed surface

Fig. 6 – Microscopic observations of orthotropic laminates (PUD) front surfaces and edges

Fig. 7 – Macroscopic observations of PUD front and back surfaces after kerosene flame exposure: (a) 5min – (b) 10min – (c) 15min

Fig. 8 – Microscopic observations of PUD after kerosene flame exposure (central specimen of the fire-exposed plate): (a) 5min – (b) 10min – (c) 15min

Fig. 9 – Microscopic observations of quasi-isotropic laminates (PQI) front surfaces and edge

Fig. 10 – Macroscopic observations of PQI front and back surfaces after kerosene flame exposure: (a) 5min – (b) 10min – (c) 15min

Fig. 11 – Microscopic observations of PQI after kerosene flame exposure (central specimen of the fire-exposed plate): (a) 5min – (b) 10min – (c) 15min

Fig. 12 – Macroscopic tensile response of orthotropic laminates after kerosene flame exposure: (a) 5min – (b) 10min – (c) 15min

Fig. 13 – Influence of kerosene flame exposure time on the tensile properties of PUD in the most degraded state (central specimen of the fire-exposed plate): (a) Axial stiffness – (b) Axial strength

Fig. 14 – Influence of kerosene flame exposure time on the tensile properties of PUD: (a) Axial stiffness – (b) Axial strength

Fig. 15 – Influence of kerosene flame exposure time on the damage mechanisms in PUD subjected to tensile loadings (central specimen of the fire-exposed plate): (a) Front and back surfaces – (b) Laminates edge

Fig. 16 – Macroscopic tensile response of quasi-isotropic laminates after kerosene flame exposure: (a) 5min – (b) 10min – (c) 15min

Fig. 17 – Influence of kerosene flame exposure time on the tensile properties of PQI (central specimen of the fire-exposed plate): (a) Axial stiffness – (b) Axial strength

Fig. 18 – Influence of kerosene flame exposure time on the tensile properties of PQI : (a) Axial stiffness – (b) Axial strength

Fig. 19 – Influence of kerosene flame exposure time on the damage mechanisms in PQI subjected to tensile loadings (central specimen of the fire-exposed plate): (a) Front and back surfaces – (b) Laminates edge

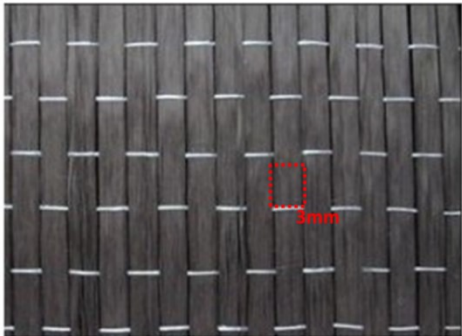

Pressure

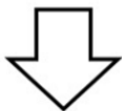

Upper heating plate

$T = 350^{\circ}\text{C}$

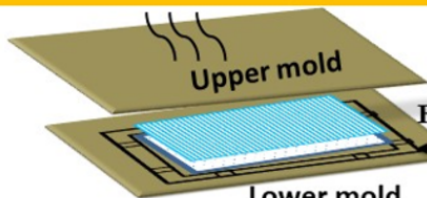

Frame

Lower mold

$T = 350^{\circ}\text{C}$

Lower heating plate



Pressure

220mm

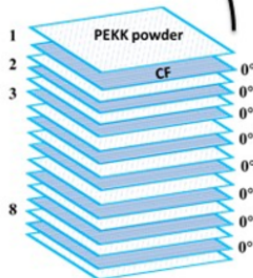
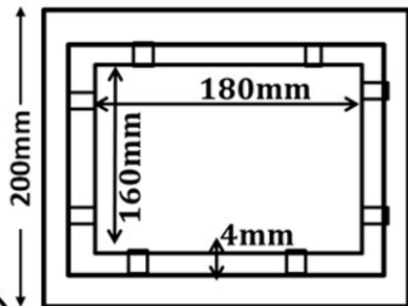

Orthotropic

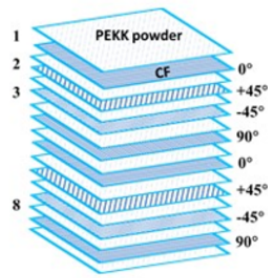

Quasi-isotropic

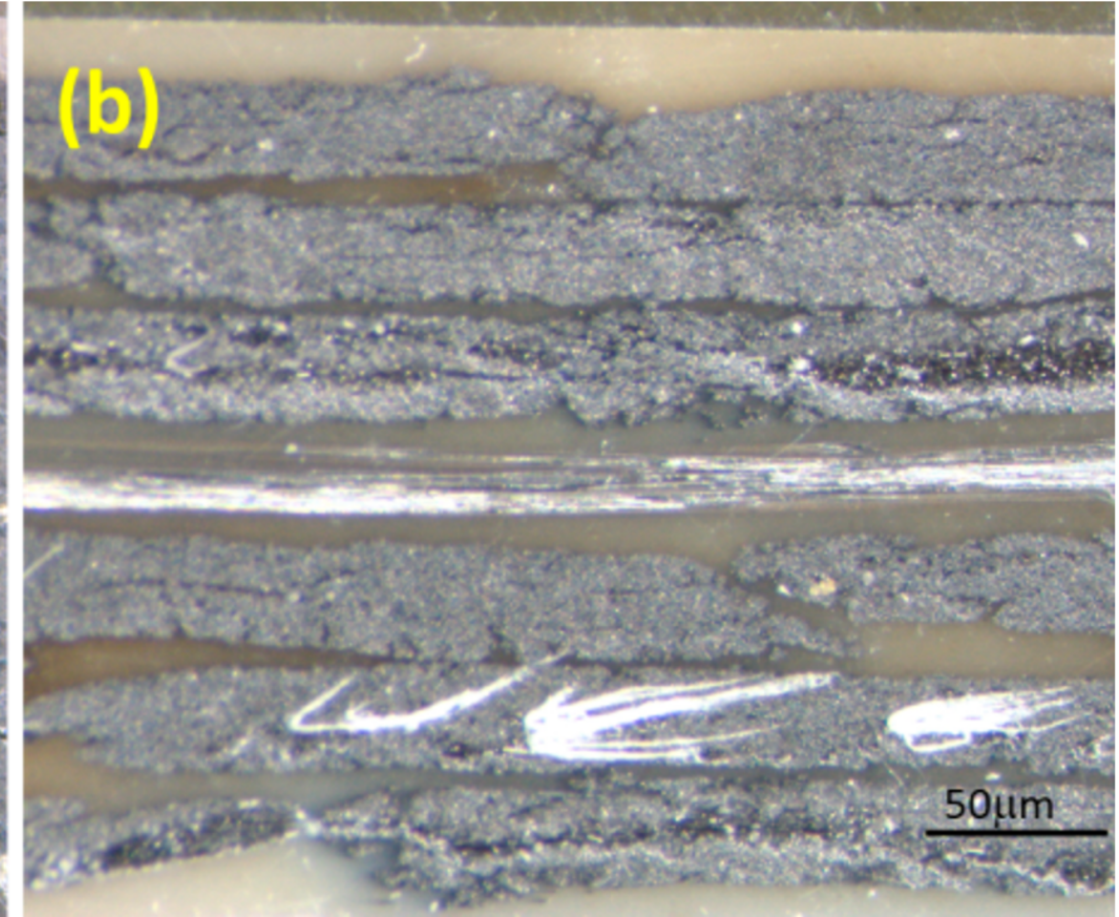
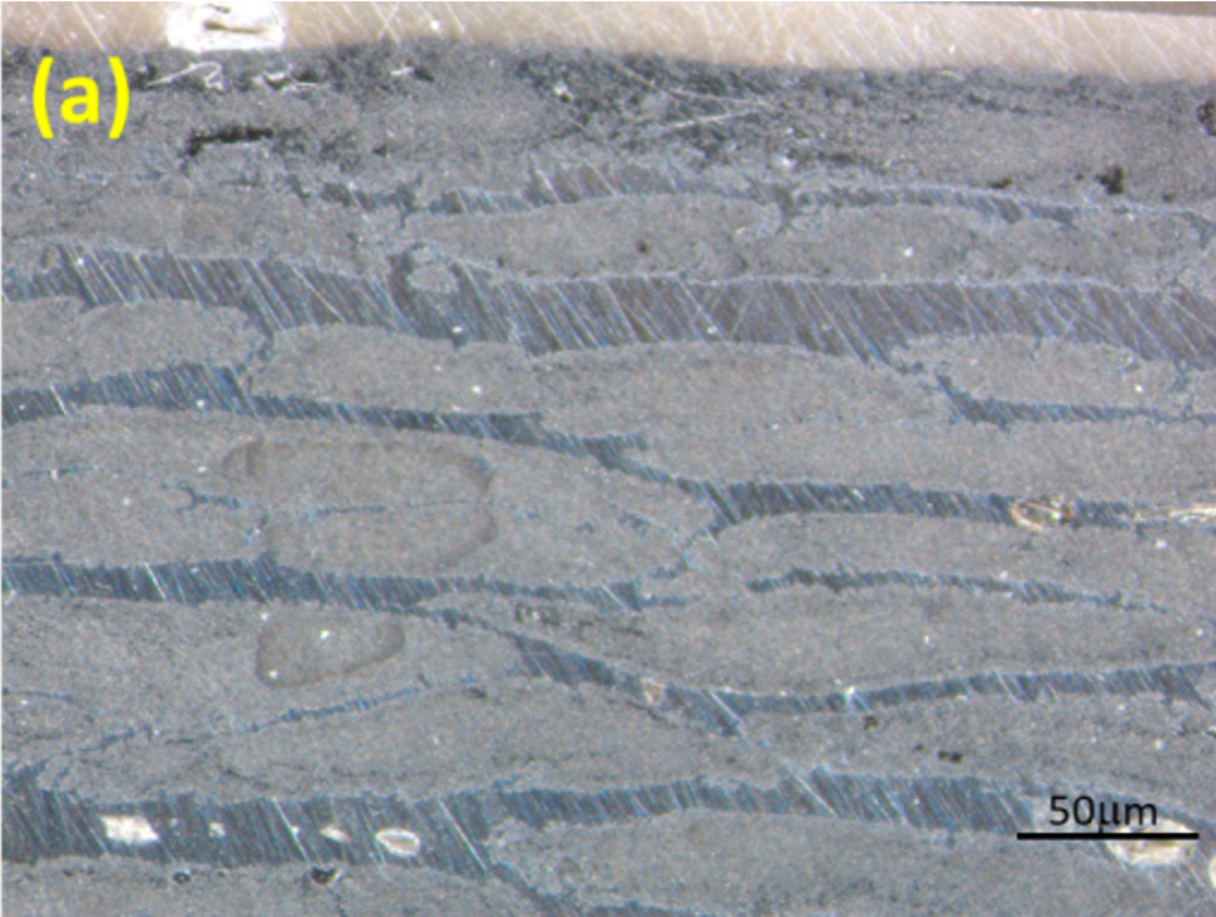

(a)



(b)

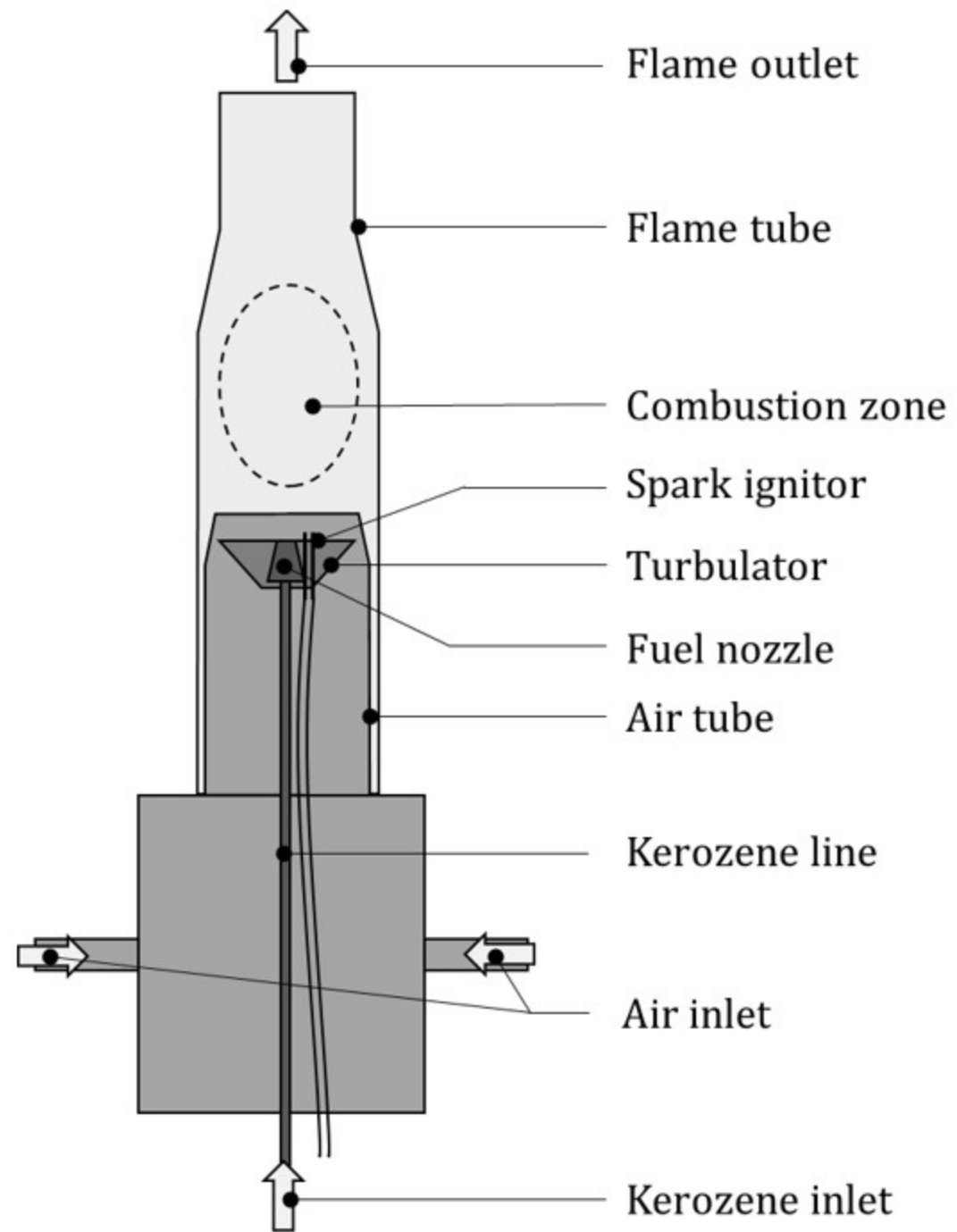

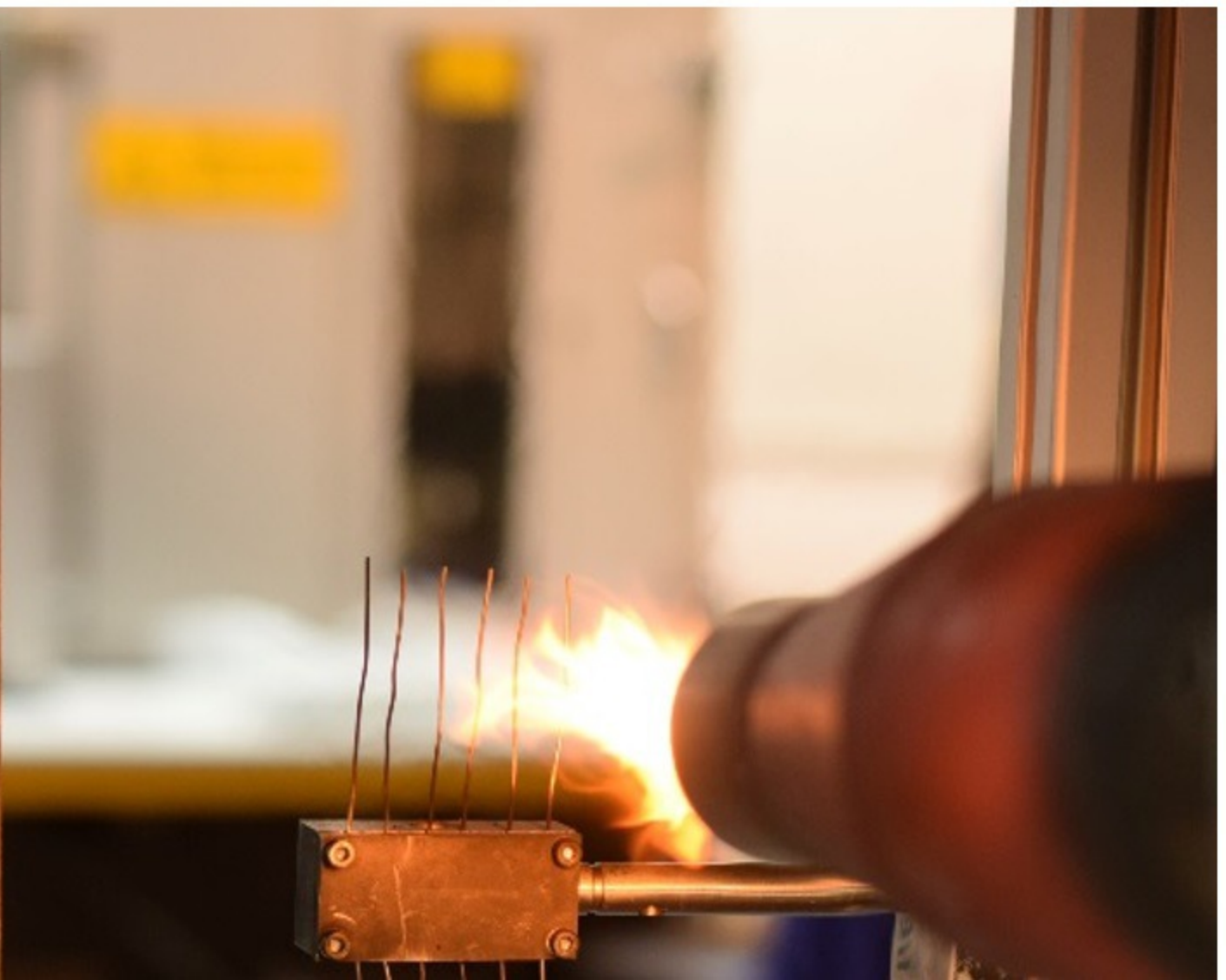
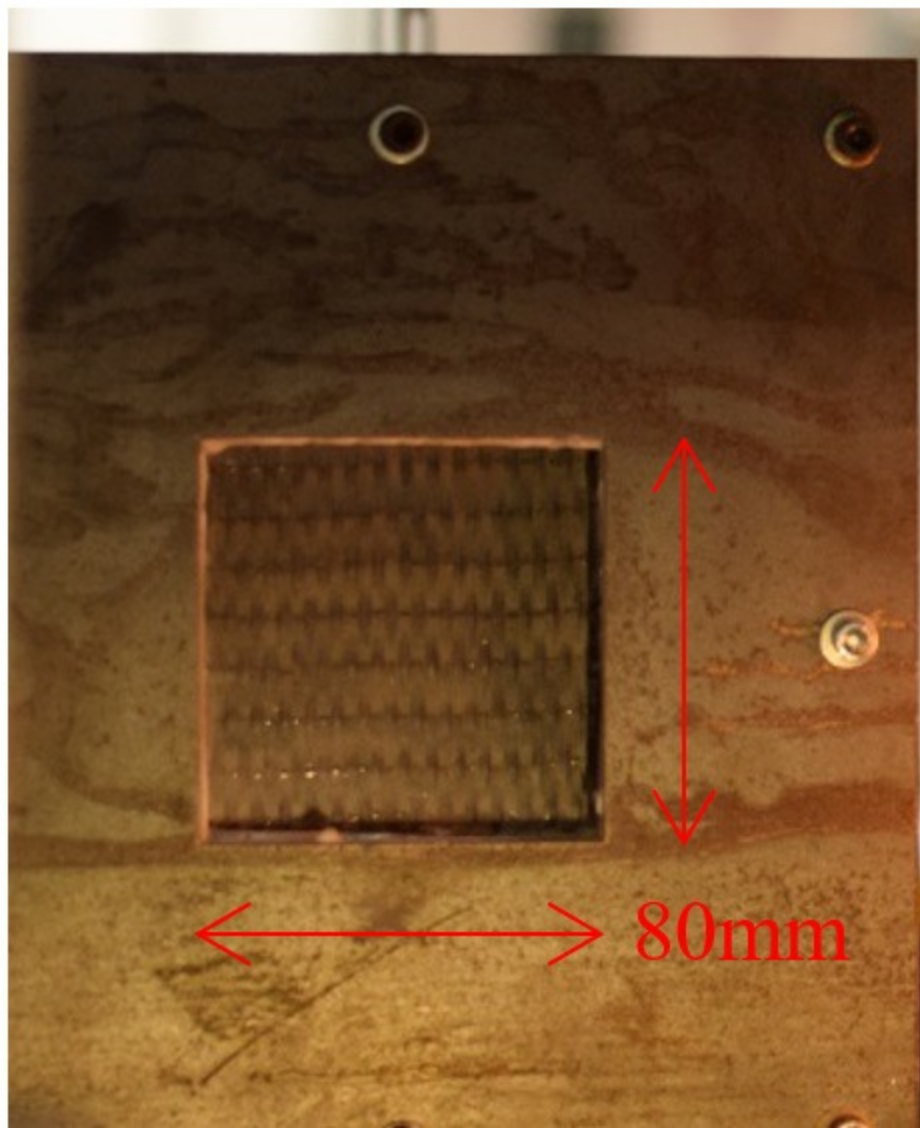

PEKK matrix

Carbon fibers



Outer surface



Laminates edge

(a)

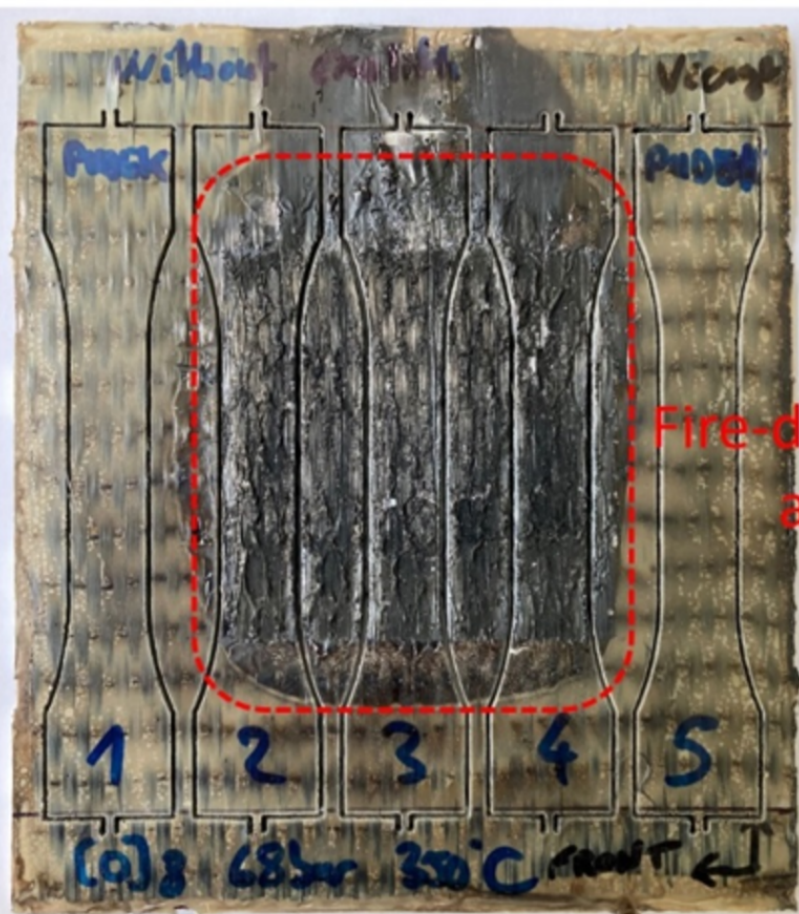

Surface exposed to kerosen flame

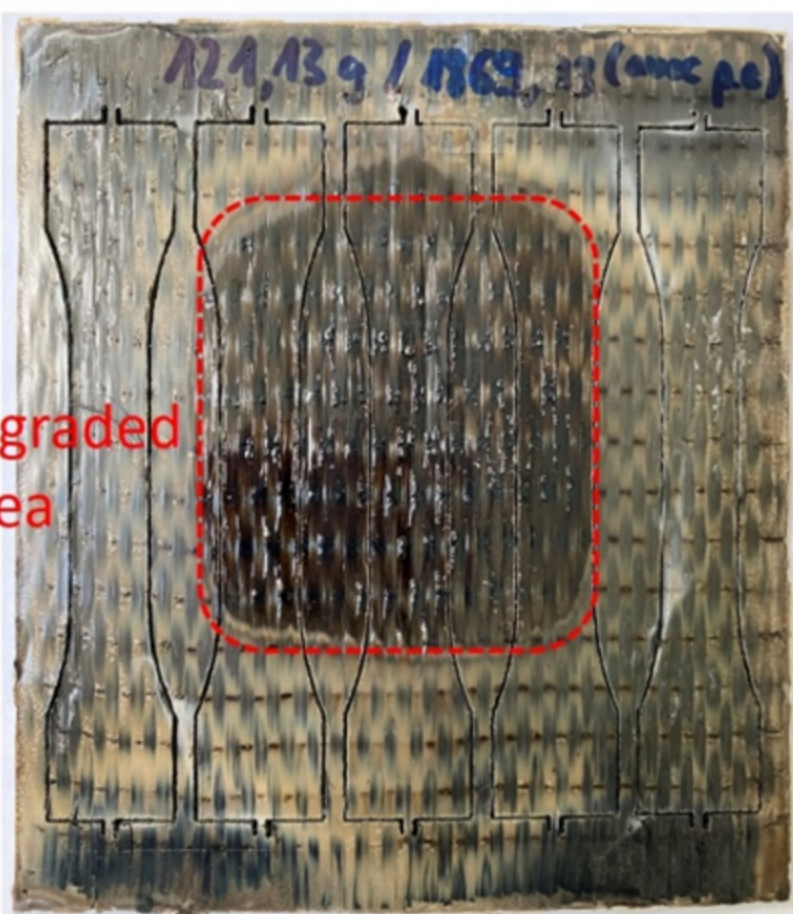

Back surface

(b)

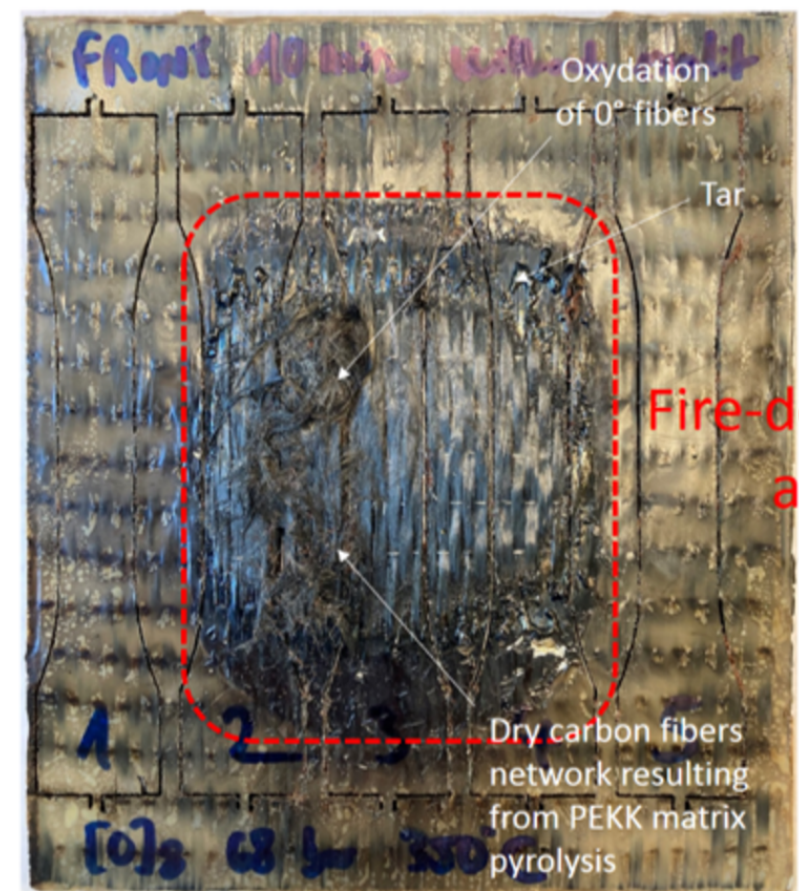

Surface exposed to kerosen flame

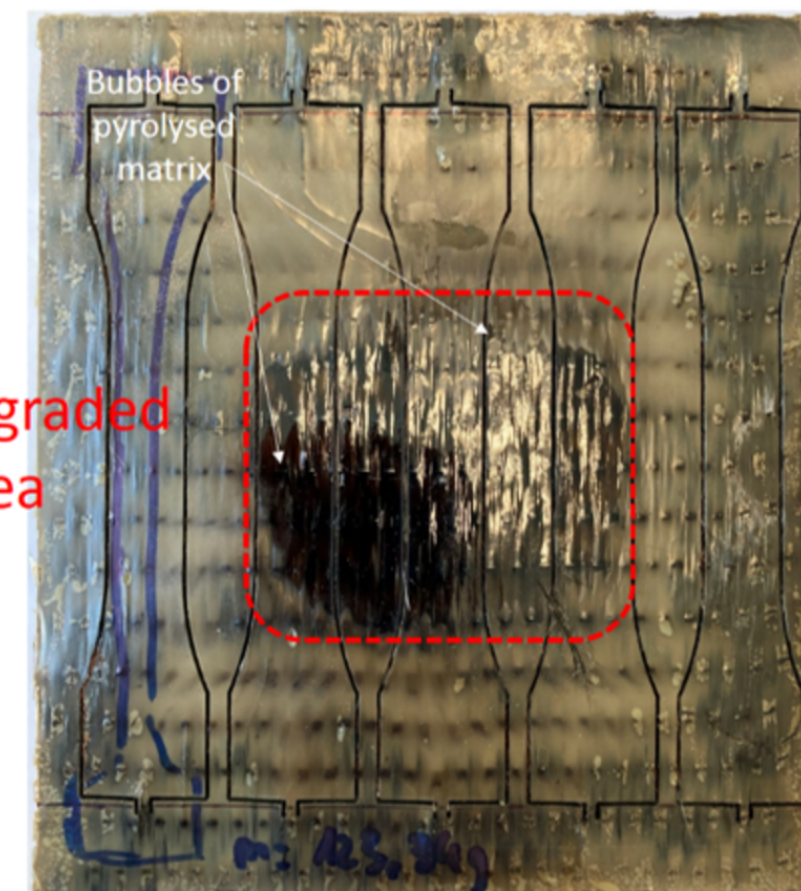

Back surface

(c)

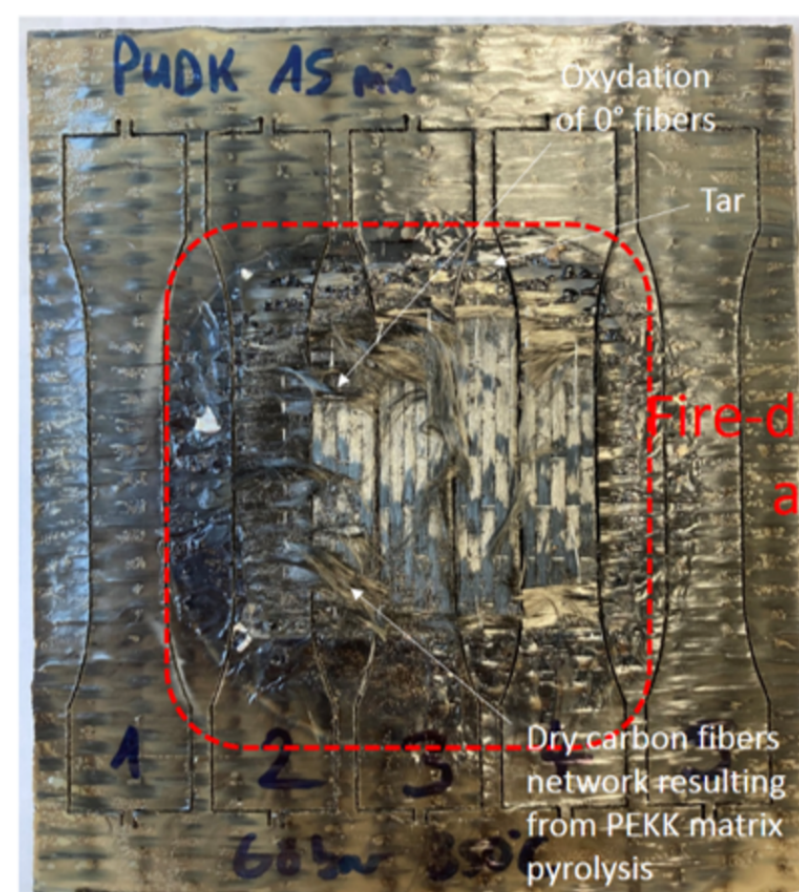

Surface exposed to kerosen flame

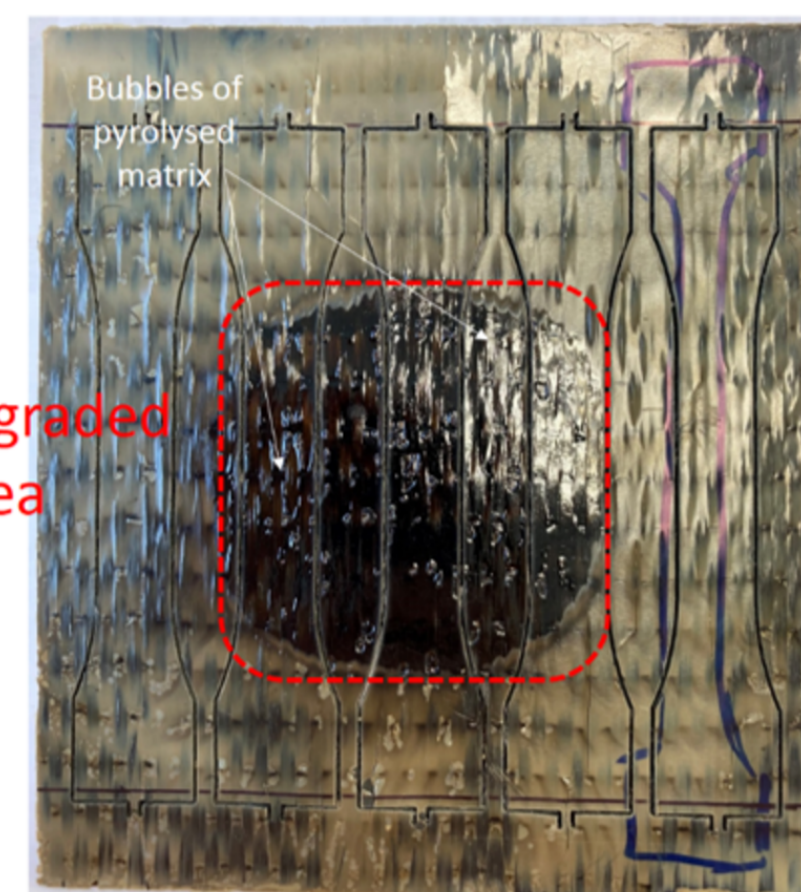

Back surface

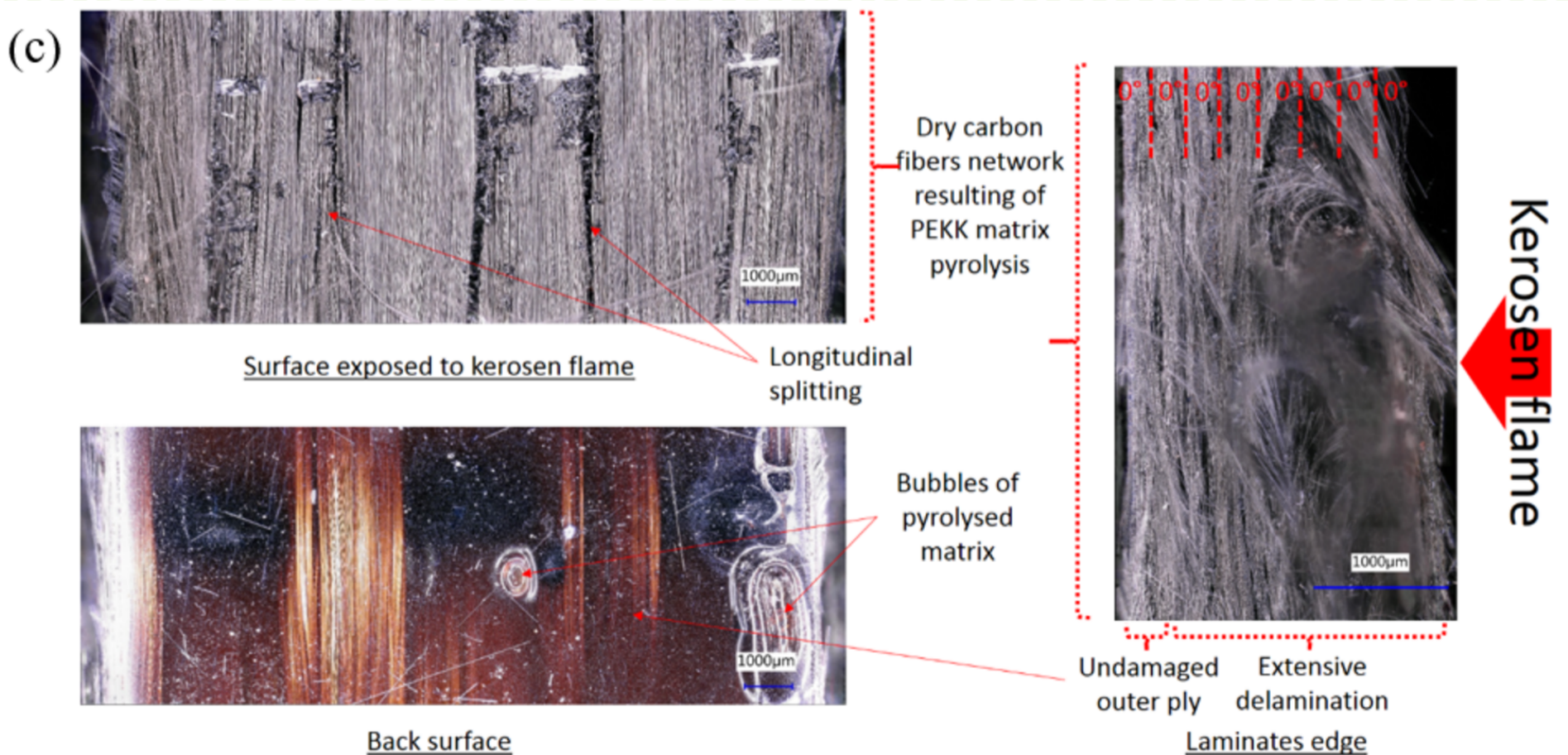
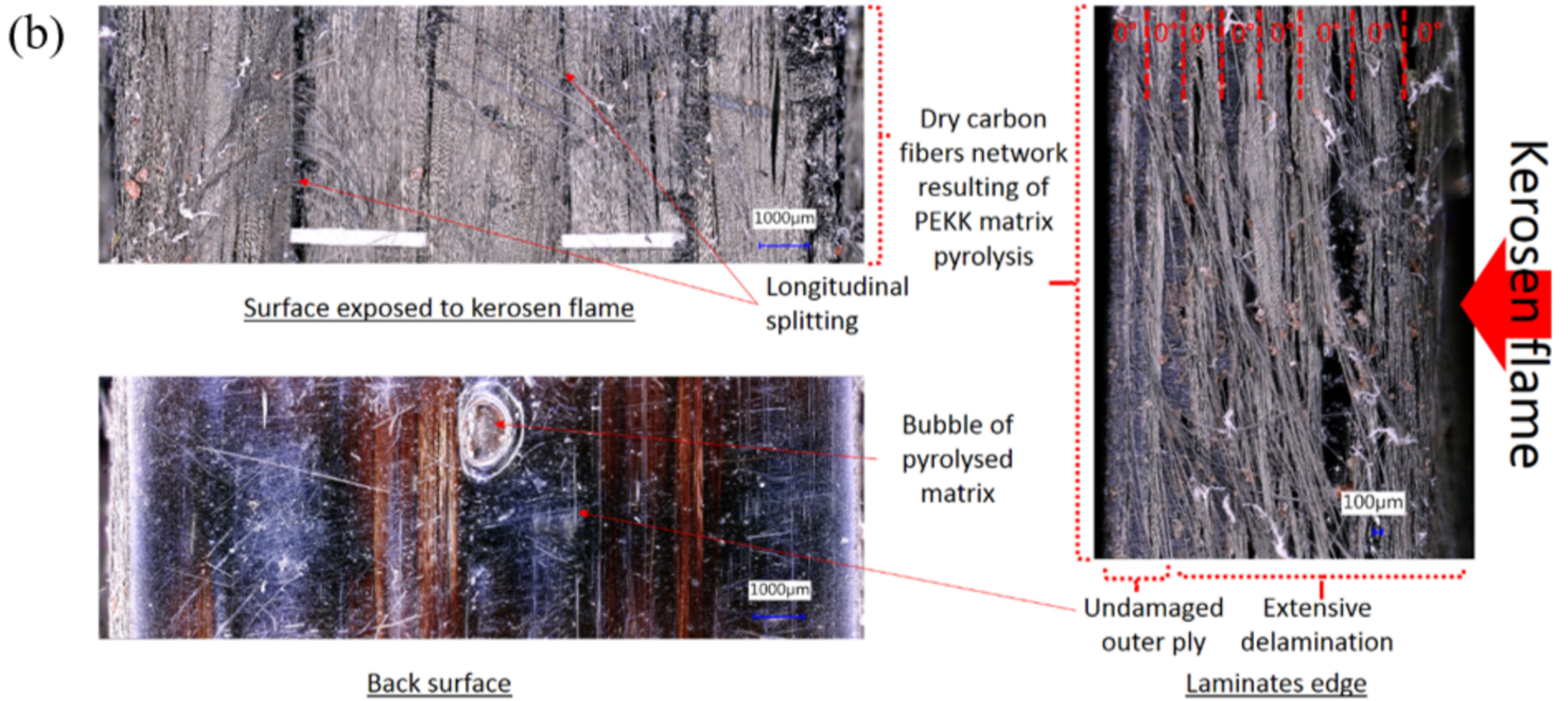
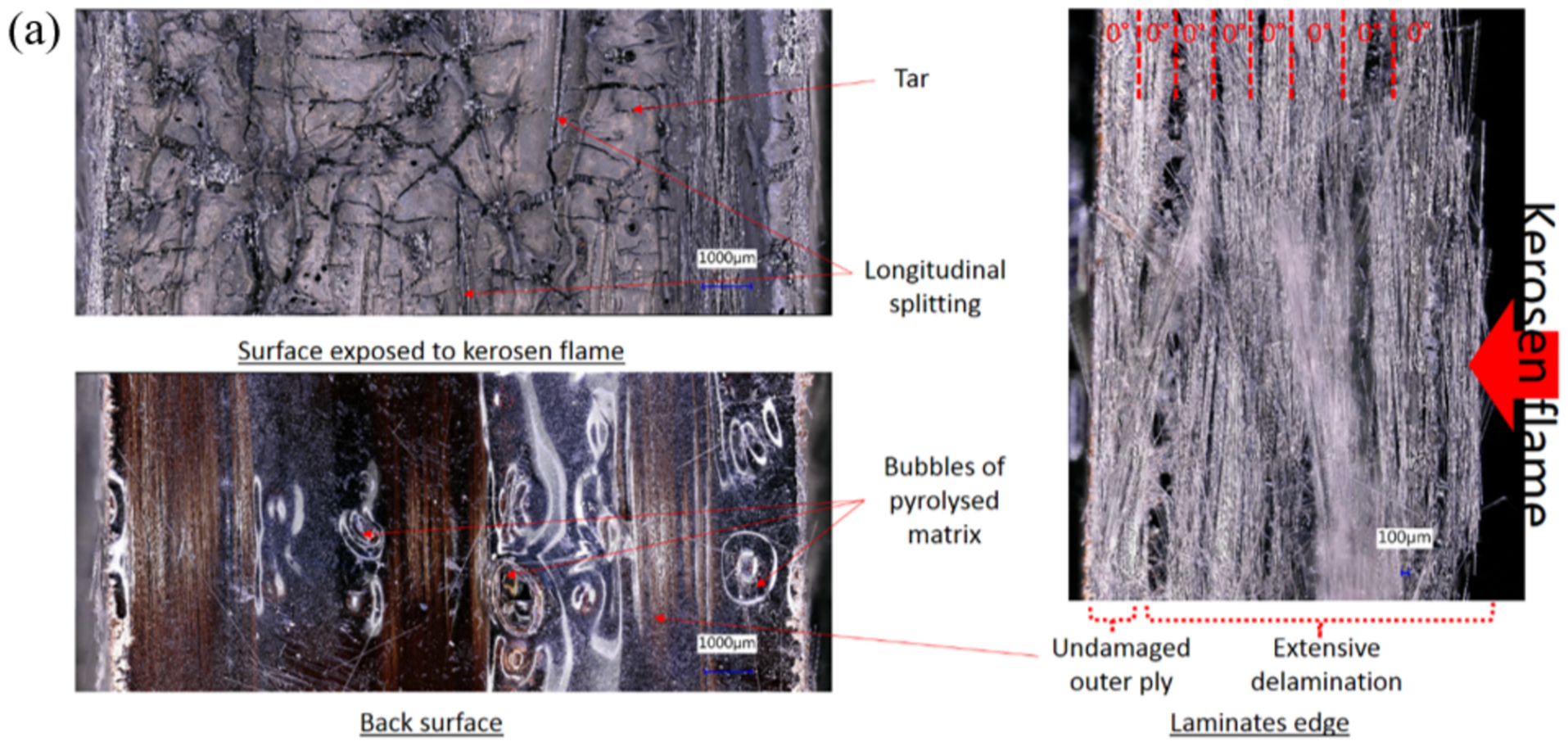



Outer virgin surface



Laminates edge

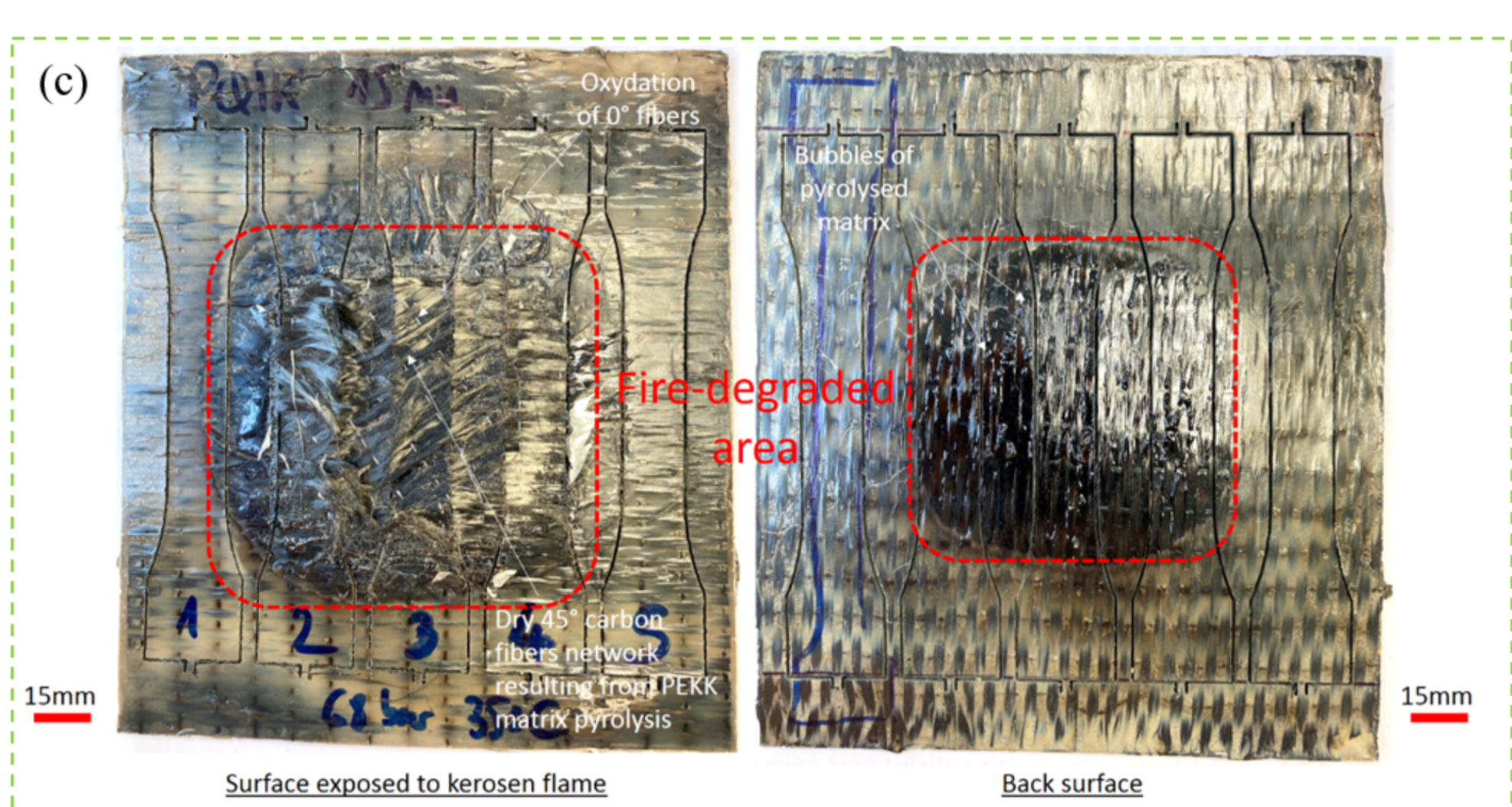
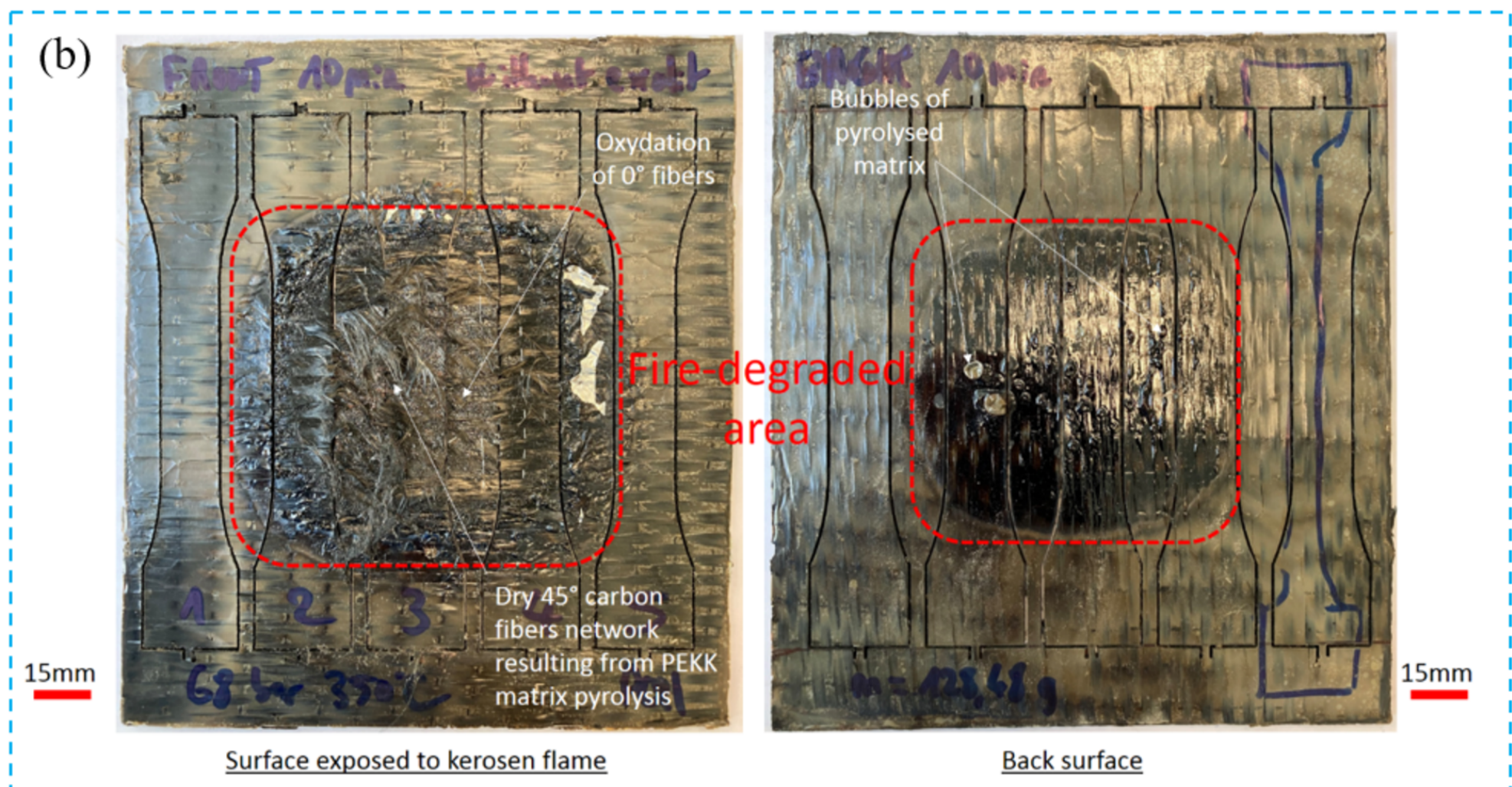
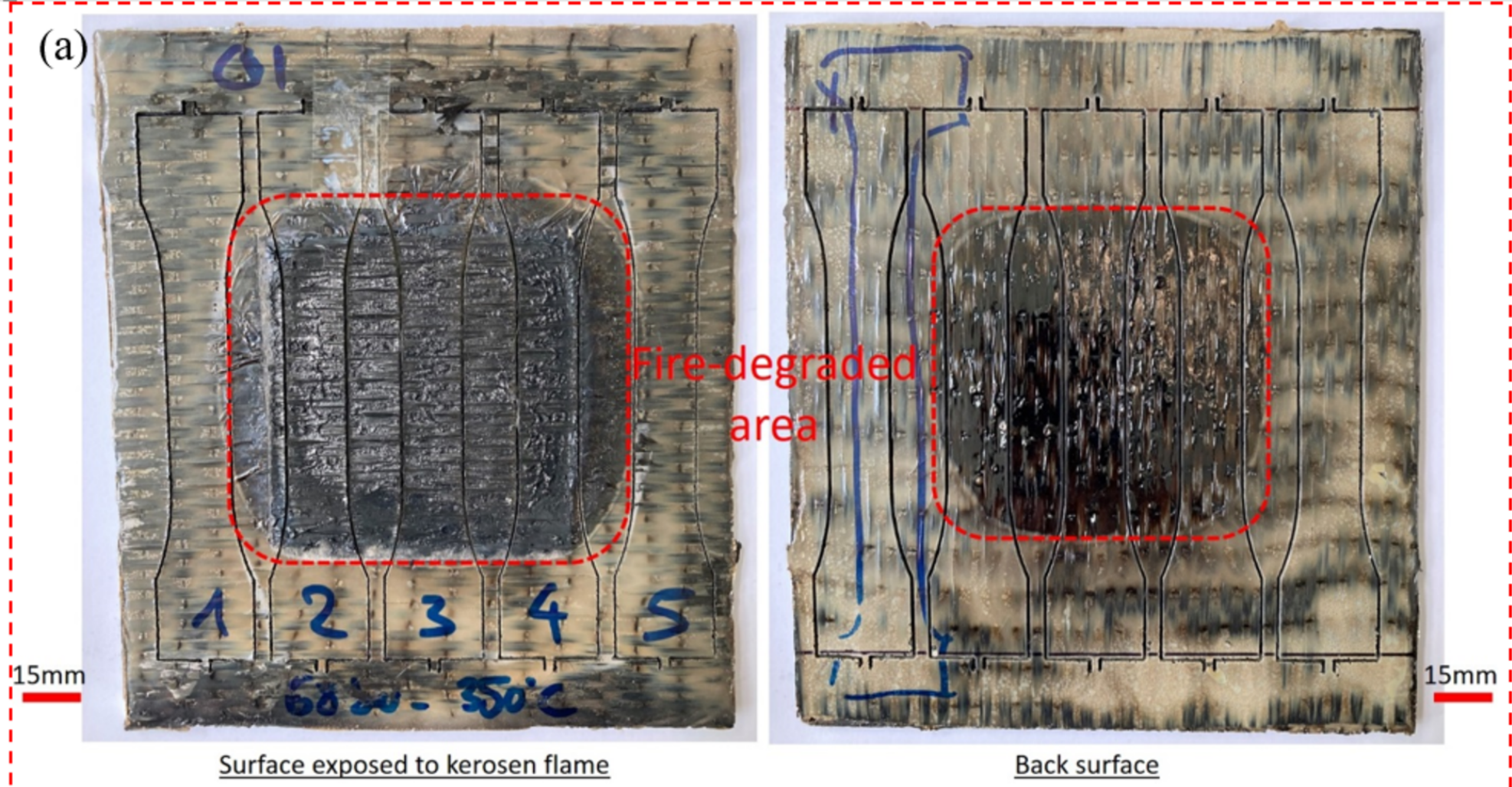

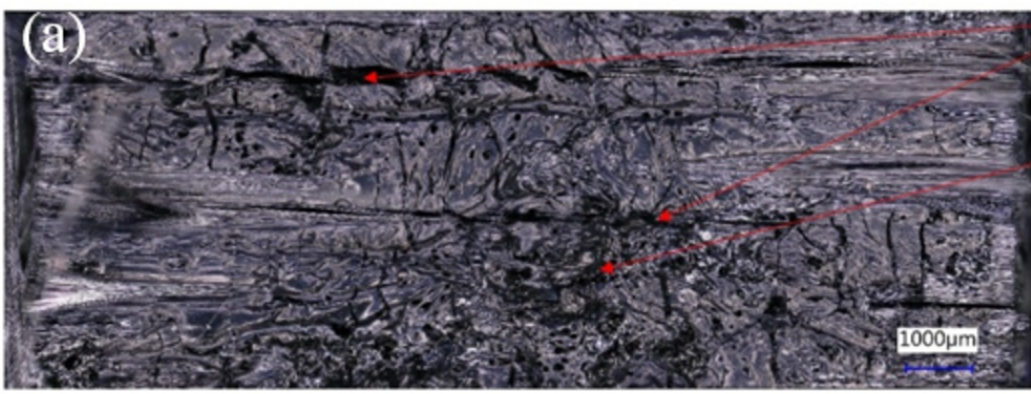

Surface exposed to kerosen flame

Transverse cracking

Tar

Kerosen flame

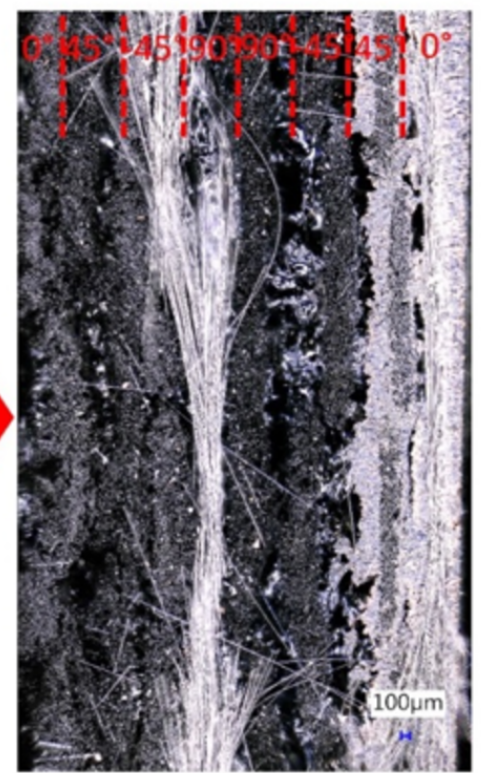

Delamination Undamaged outer ply

Laminates edge



Back surface

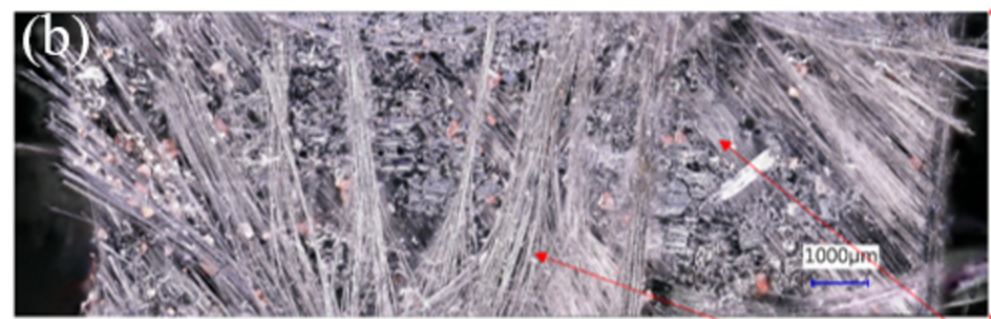

Surface exposed to kerosen flame

Dry carbon fibers network resulting from PEKK matrix pyrolysis

+45° oriented plies: oxydation of the 0° carbon fibers



Kerosen flame

Undamaged PEKK matrix Oxydation outer ply pyrolysis of 0° fibers

Laminates edge

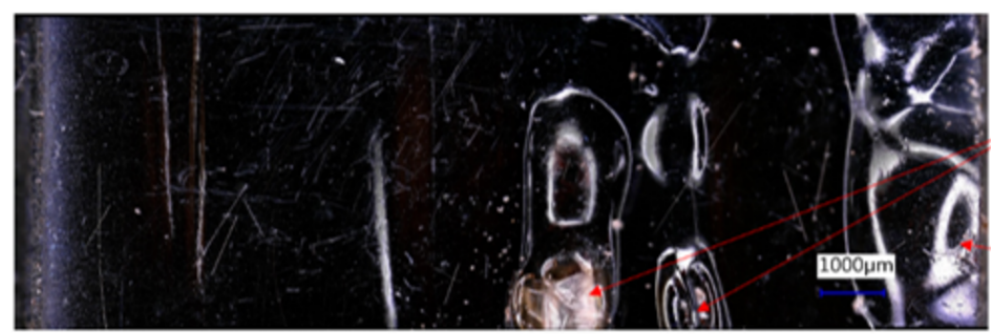

Back surface

Bubbles of pyrolysed matrix



Surface exposed to kerosen flame

Dry 45° carbon fibers network resulting from PEKK matrix pyrolysis

+45° oriented plies: oxydation of the 0° carbon fibers

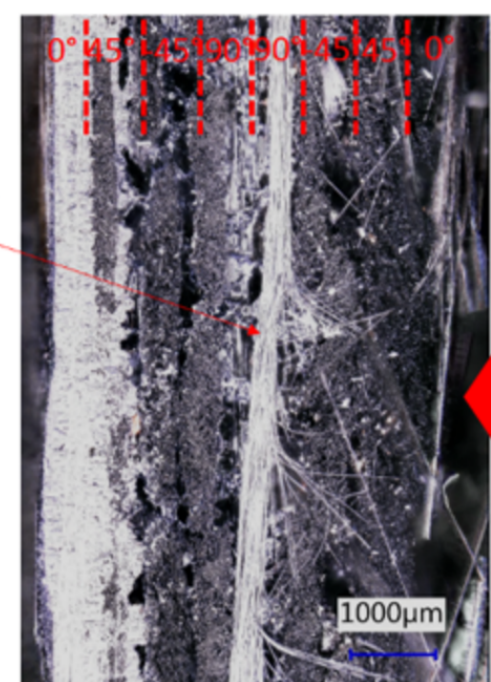

Kerosen flame

Undamaged PEKK matrix Oxydation outer ply pyrolysis of 0° fibers

Laminates edge

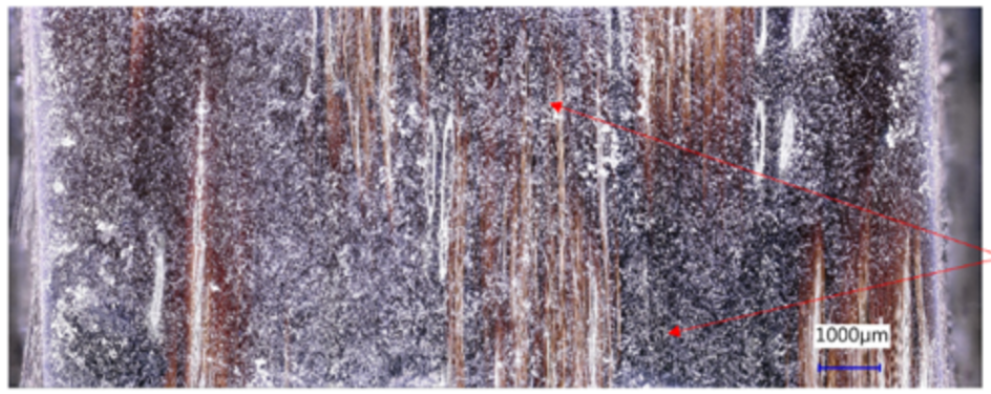

Back surface

PEKK matrix color change due to the onset of pyrolysis

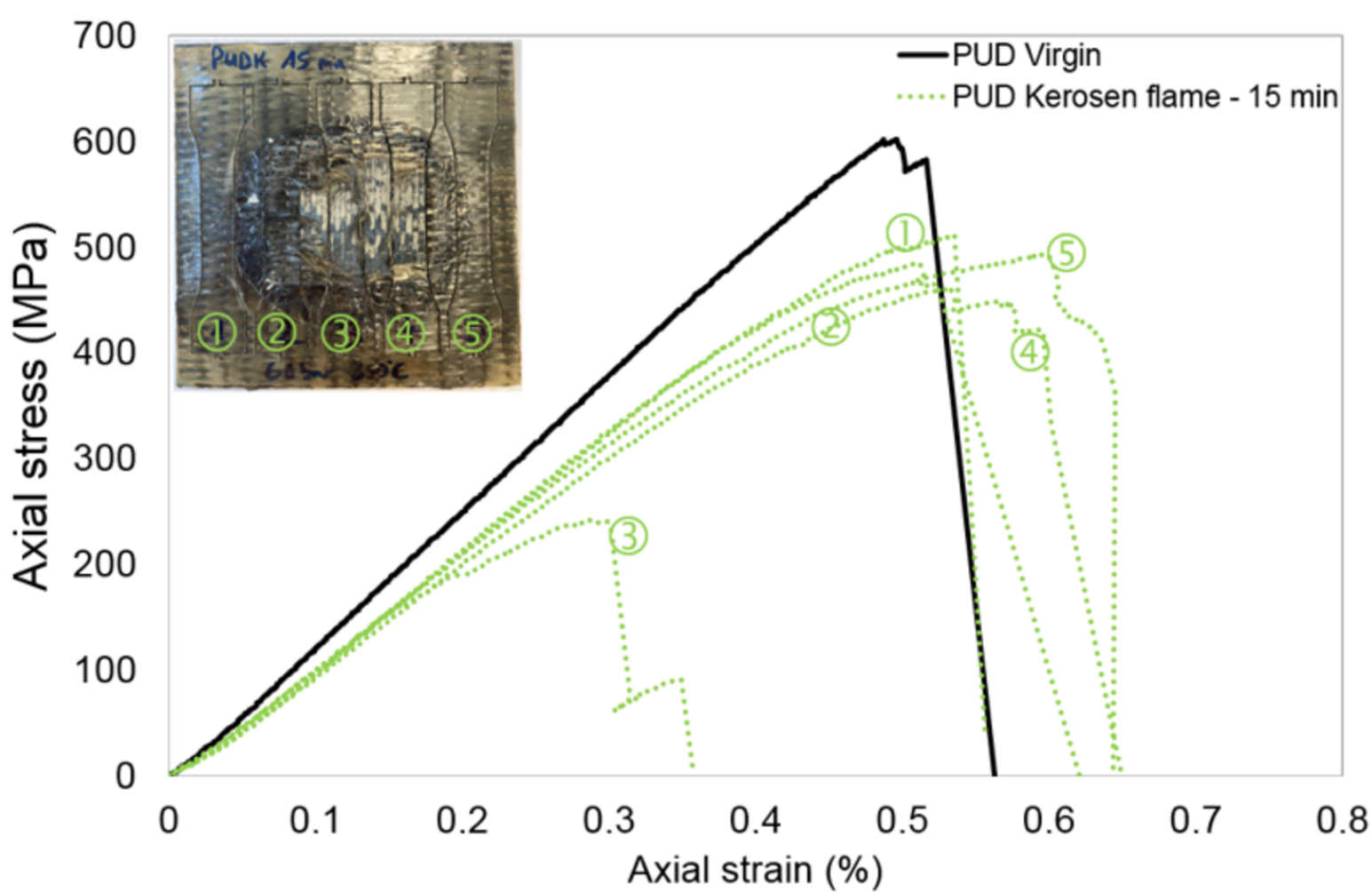
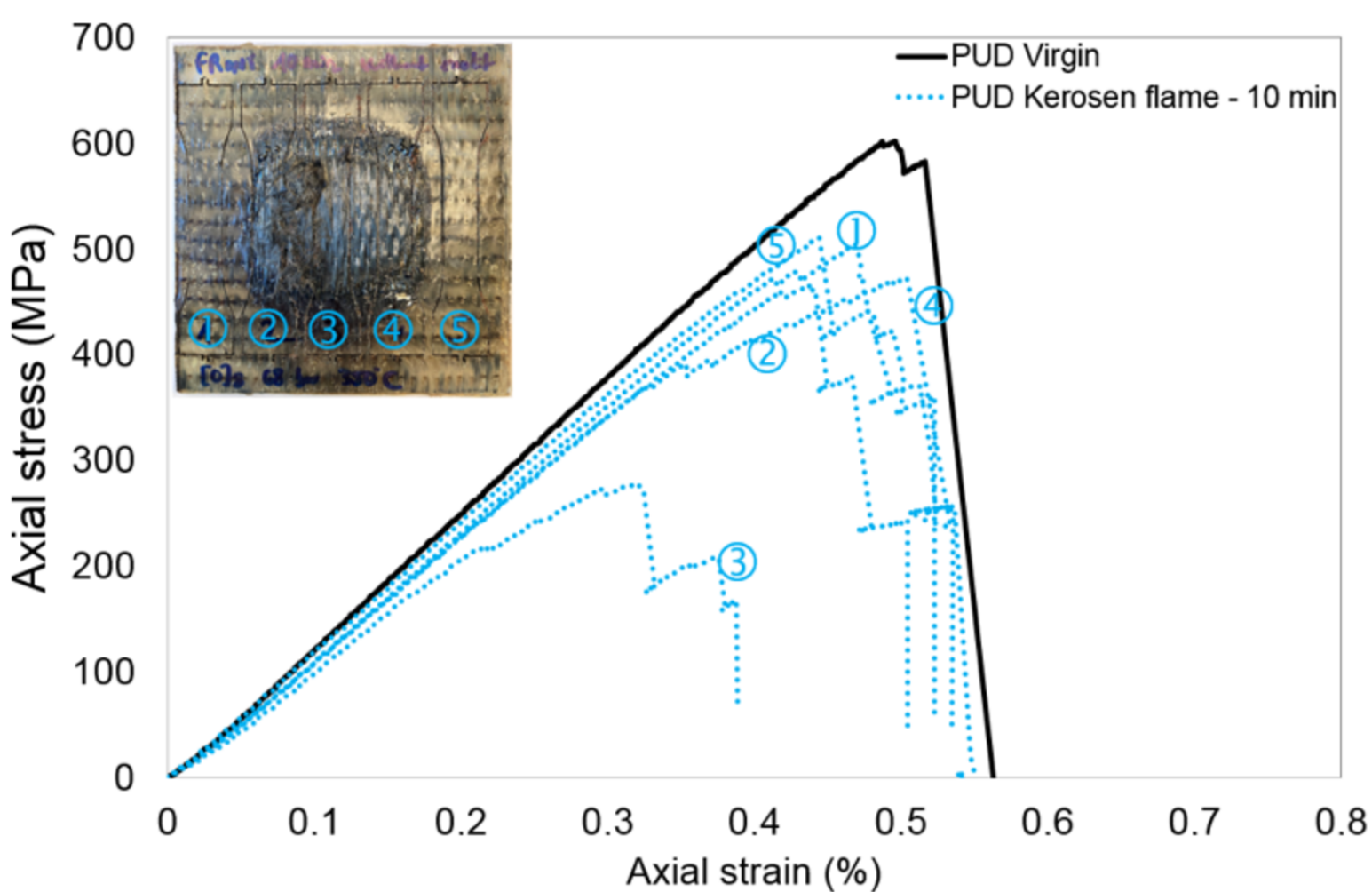
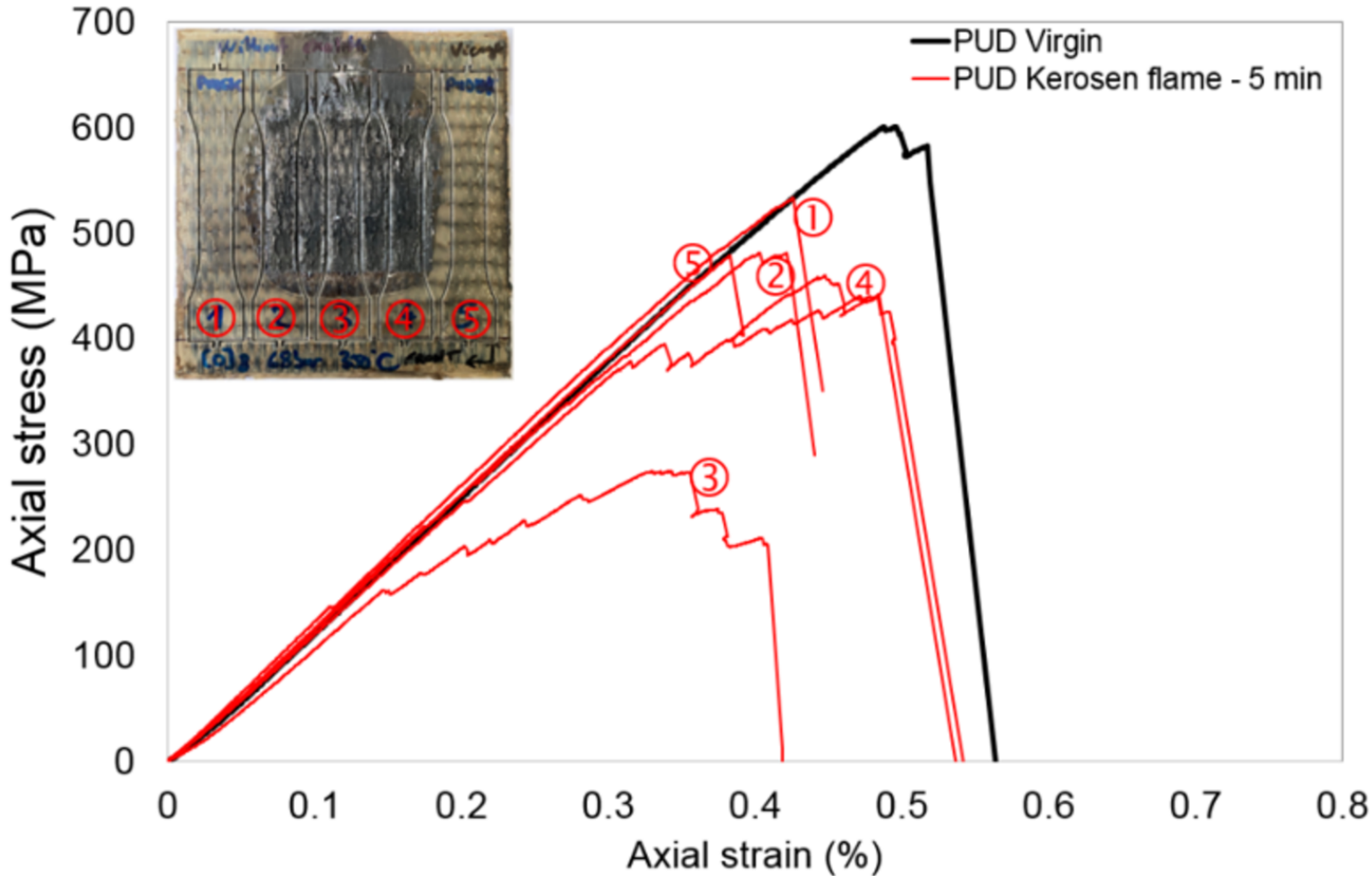

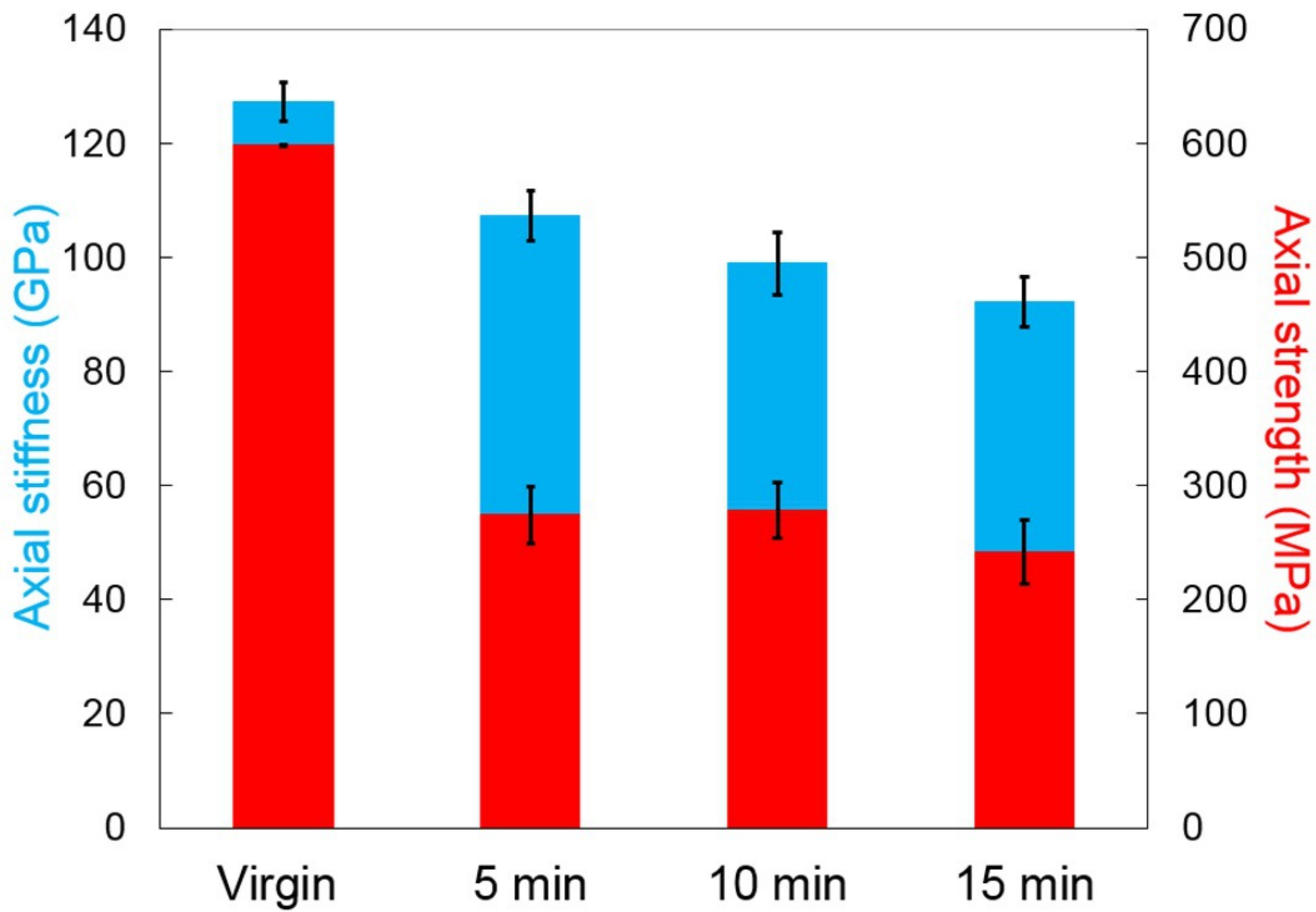

(a)

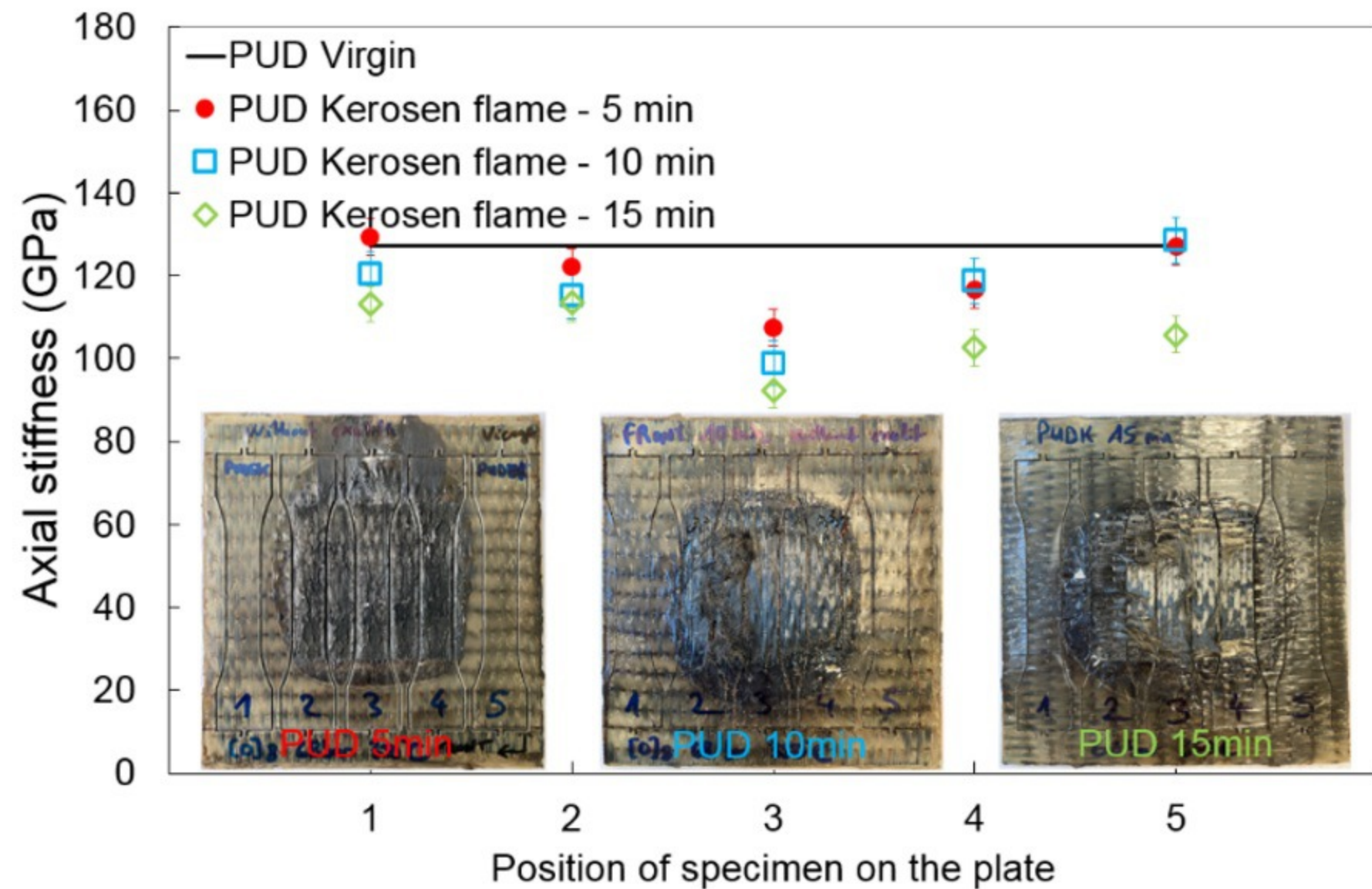

(b)

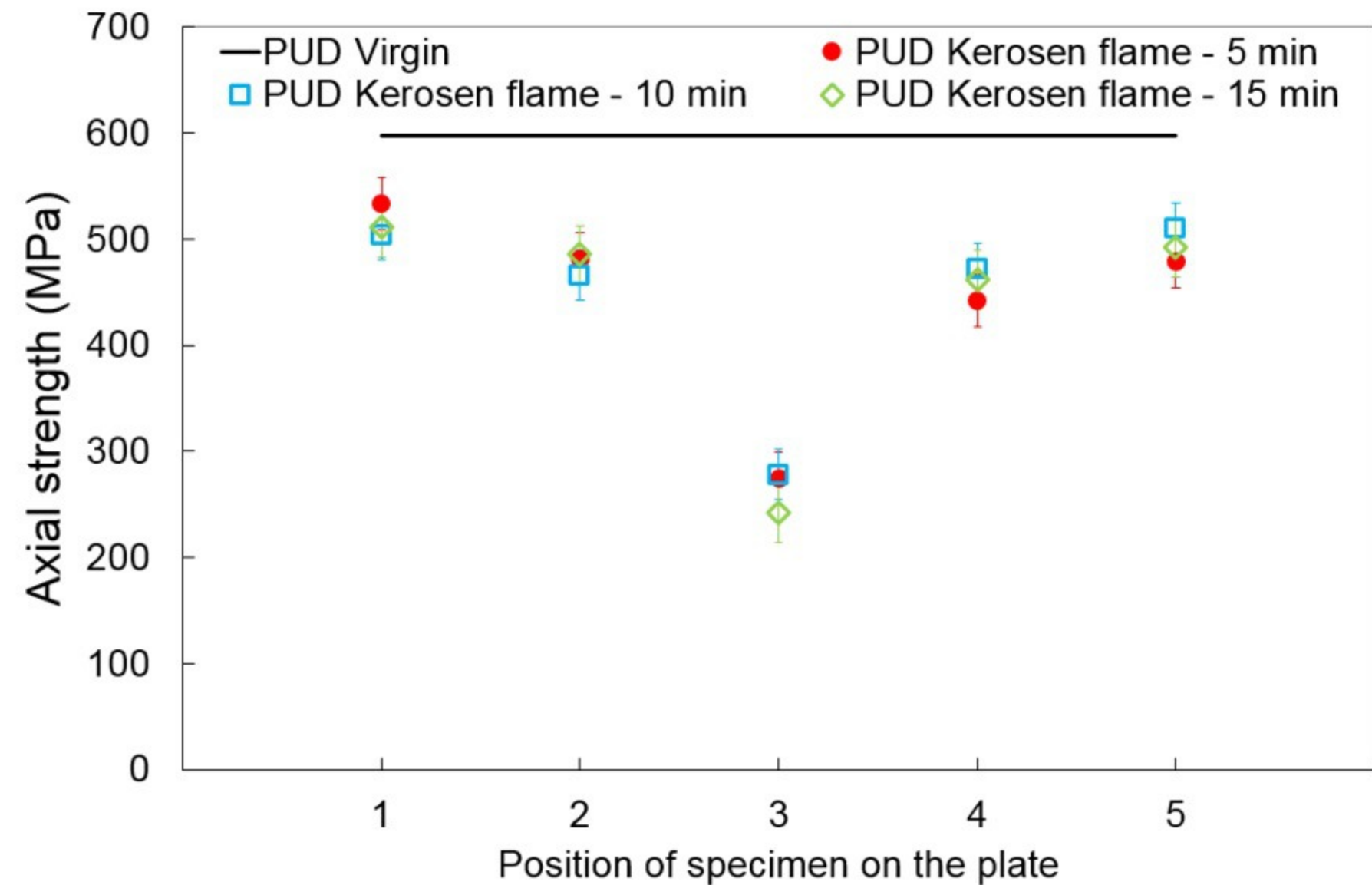

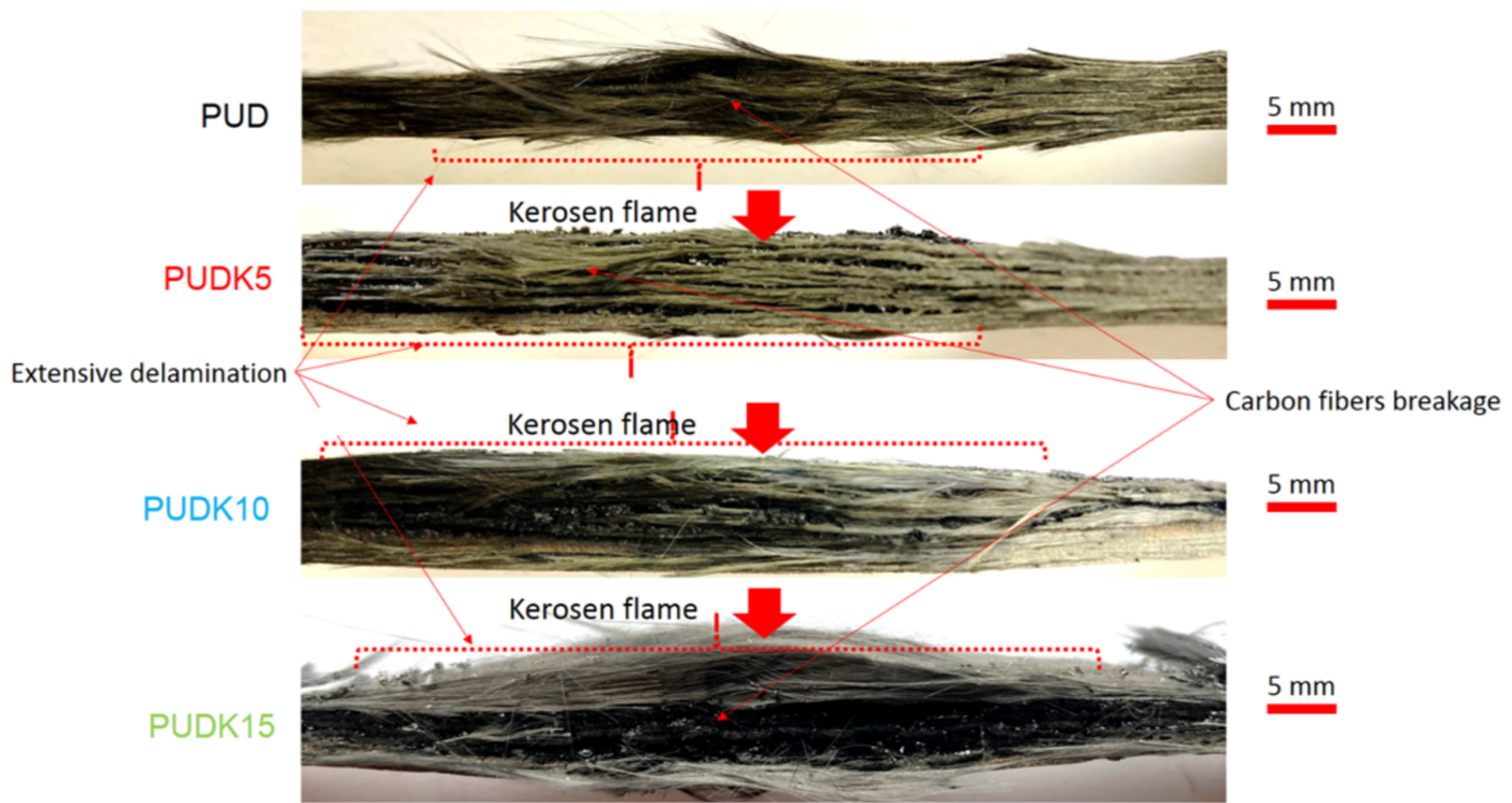
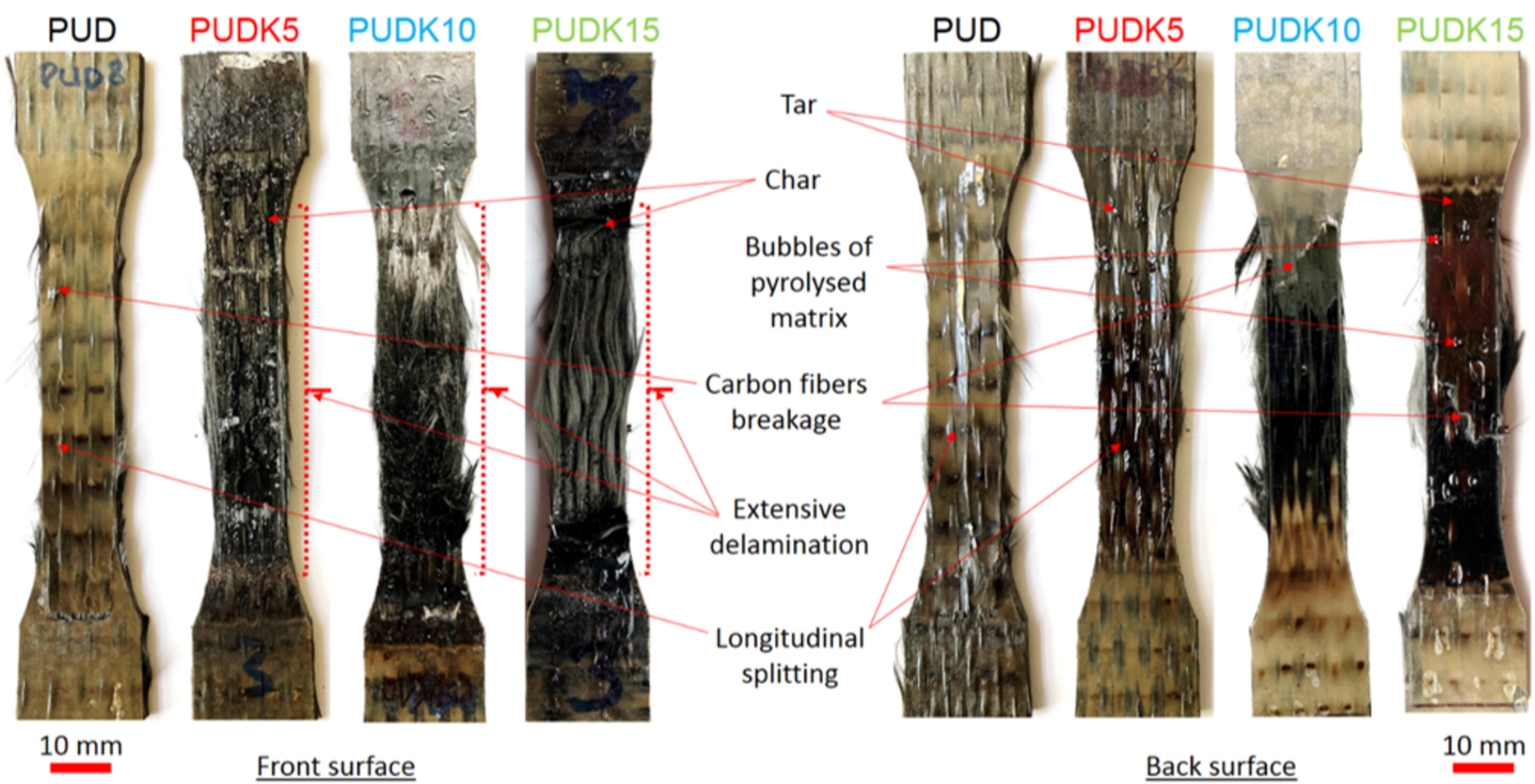

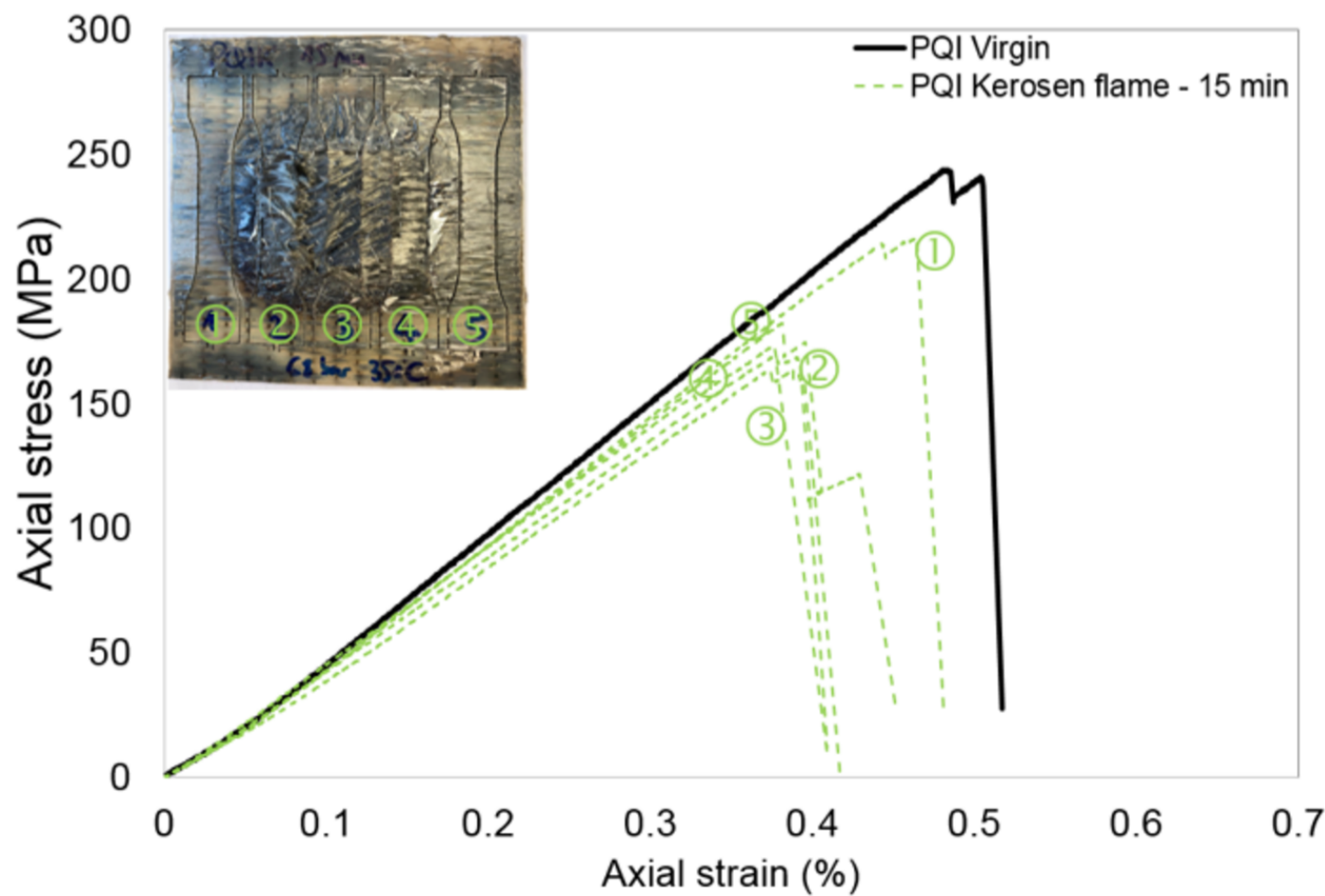
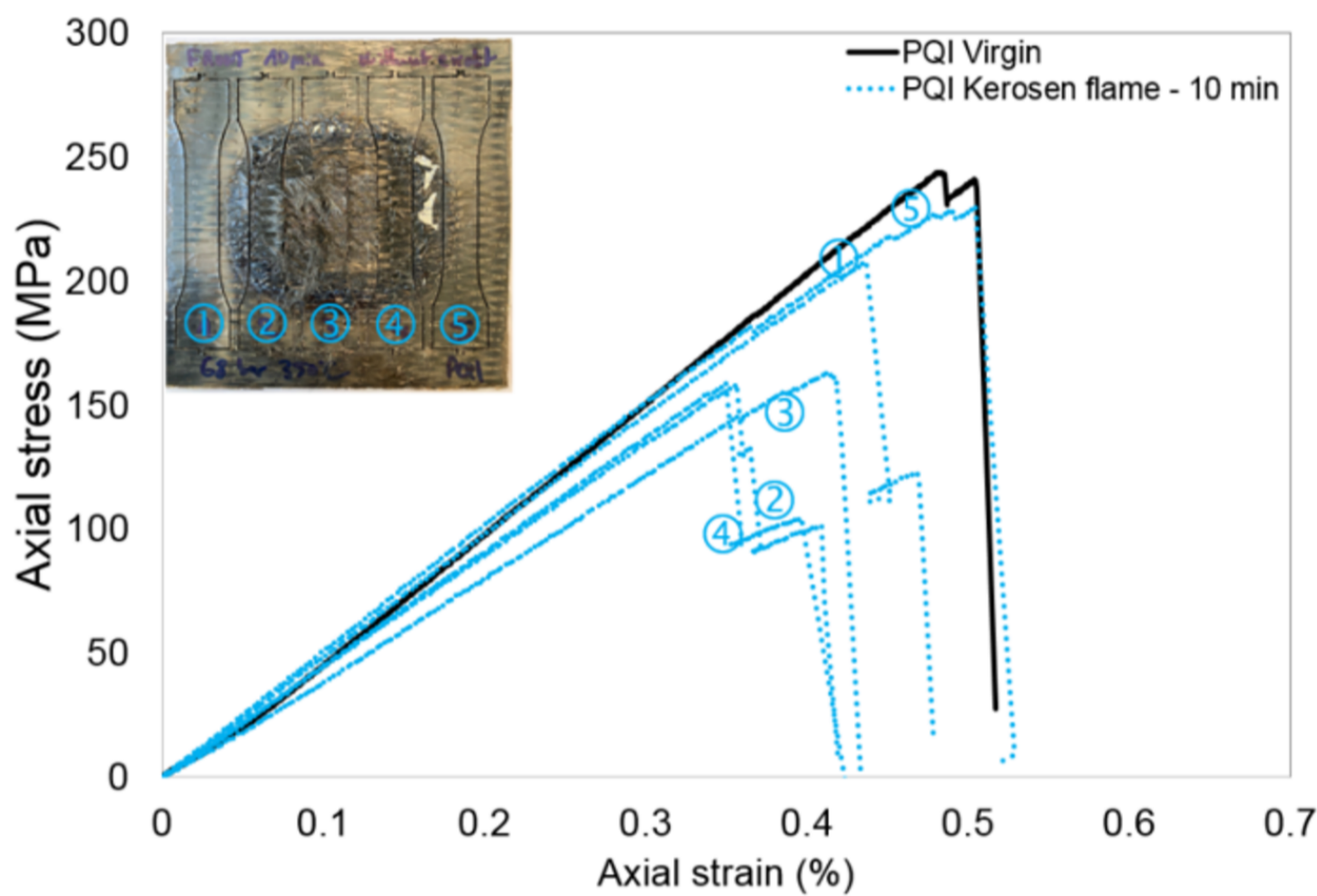
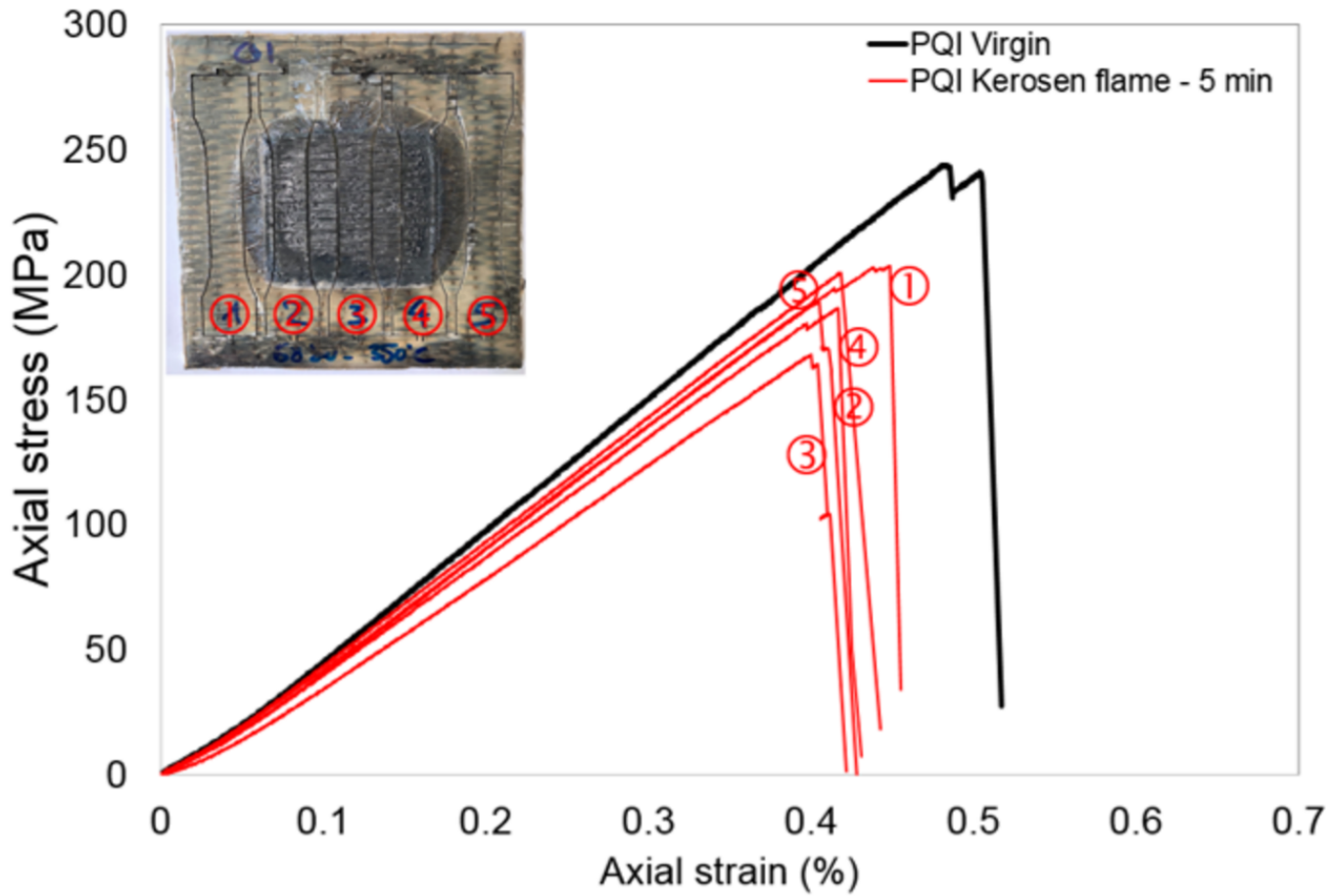

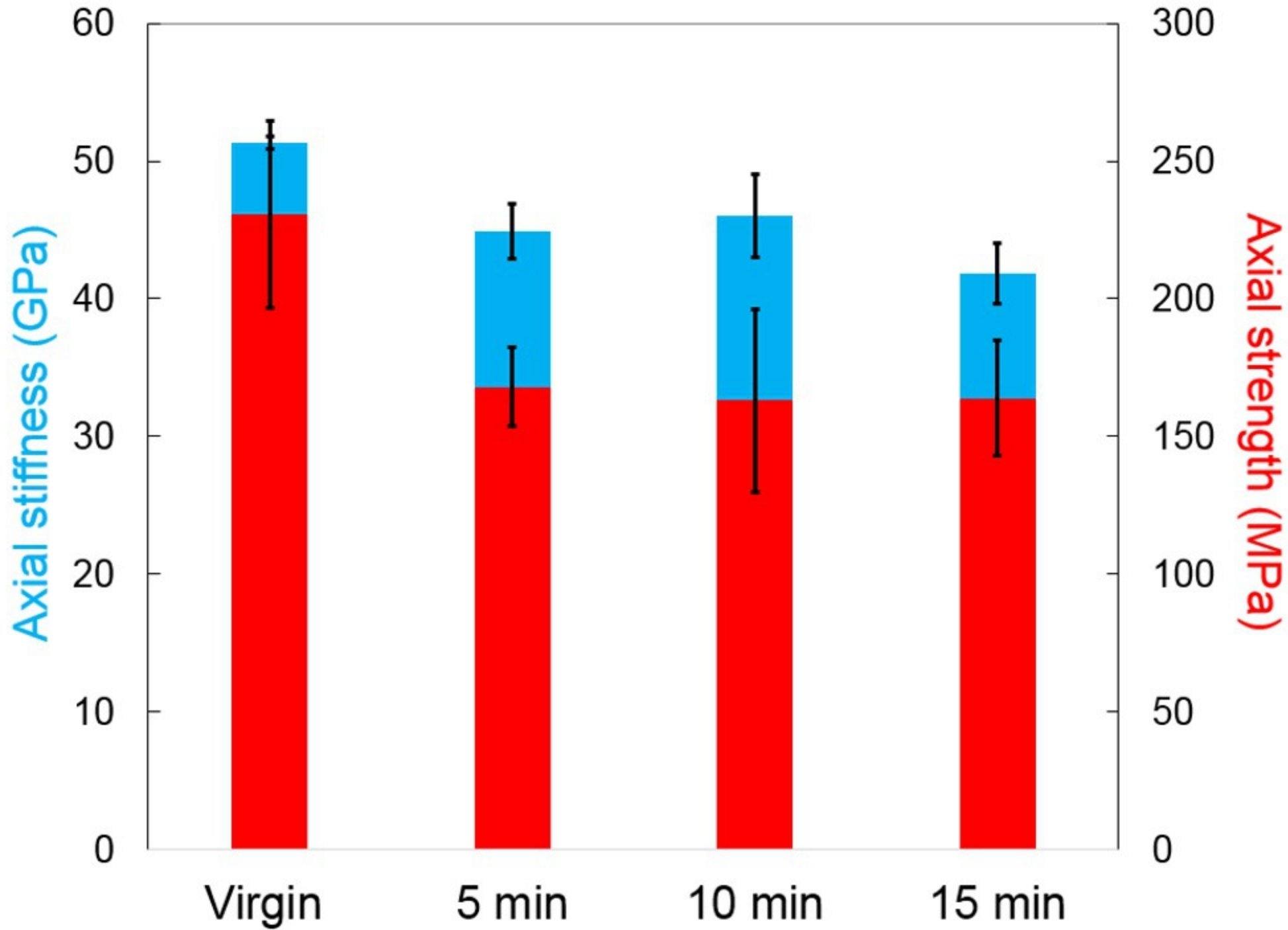

(a)

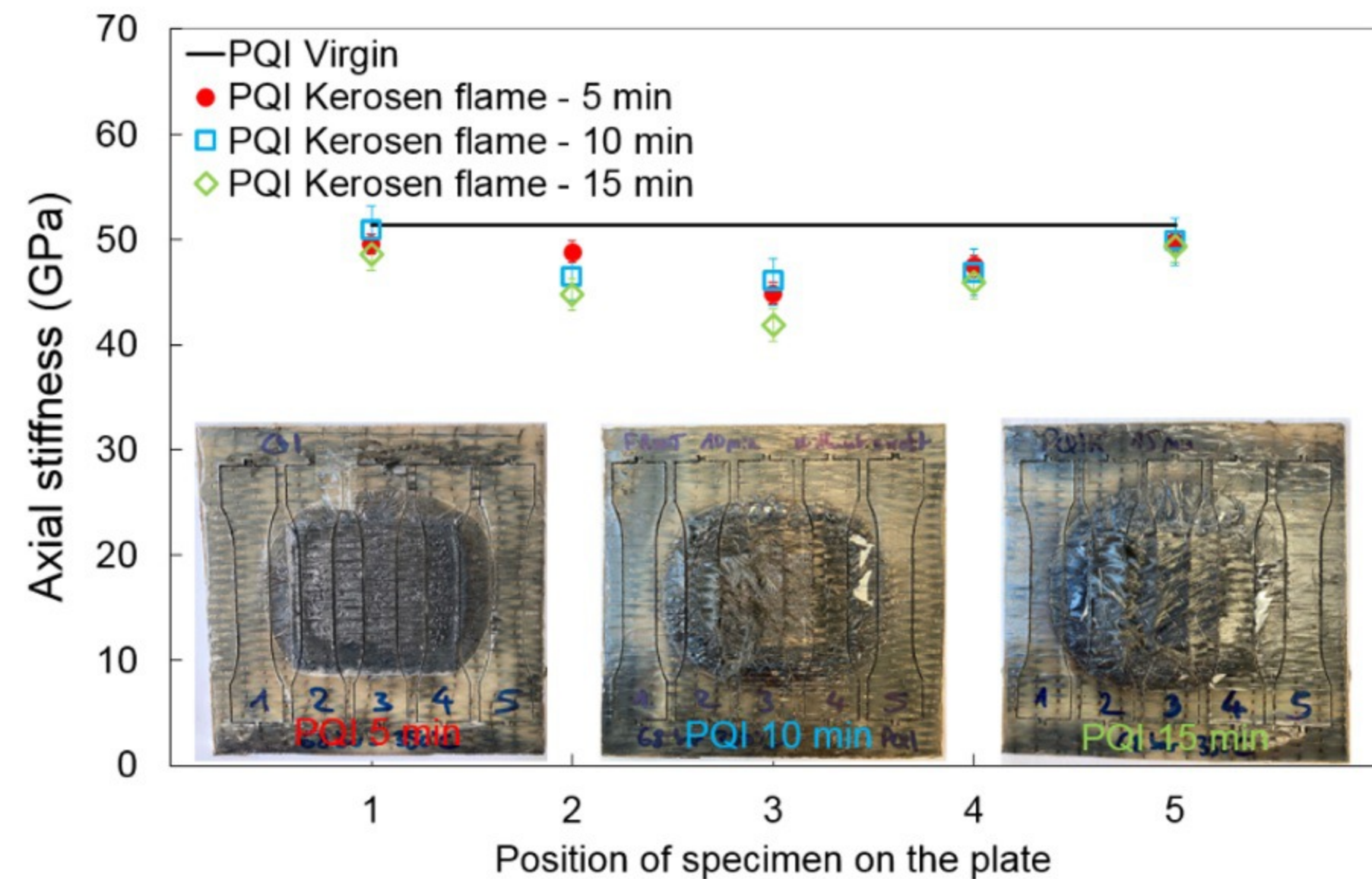

(b)

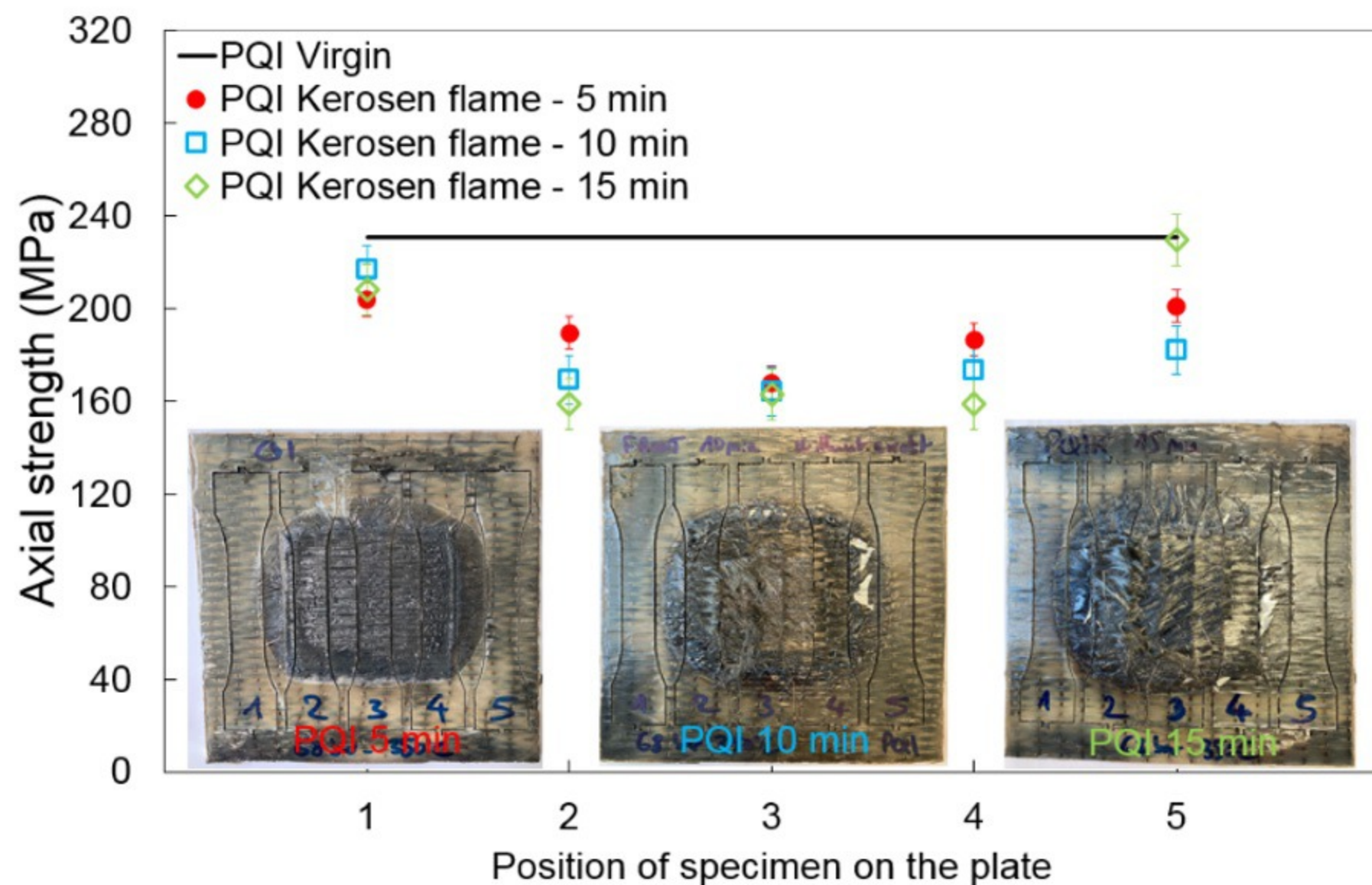

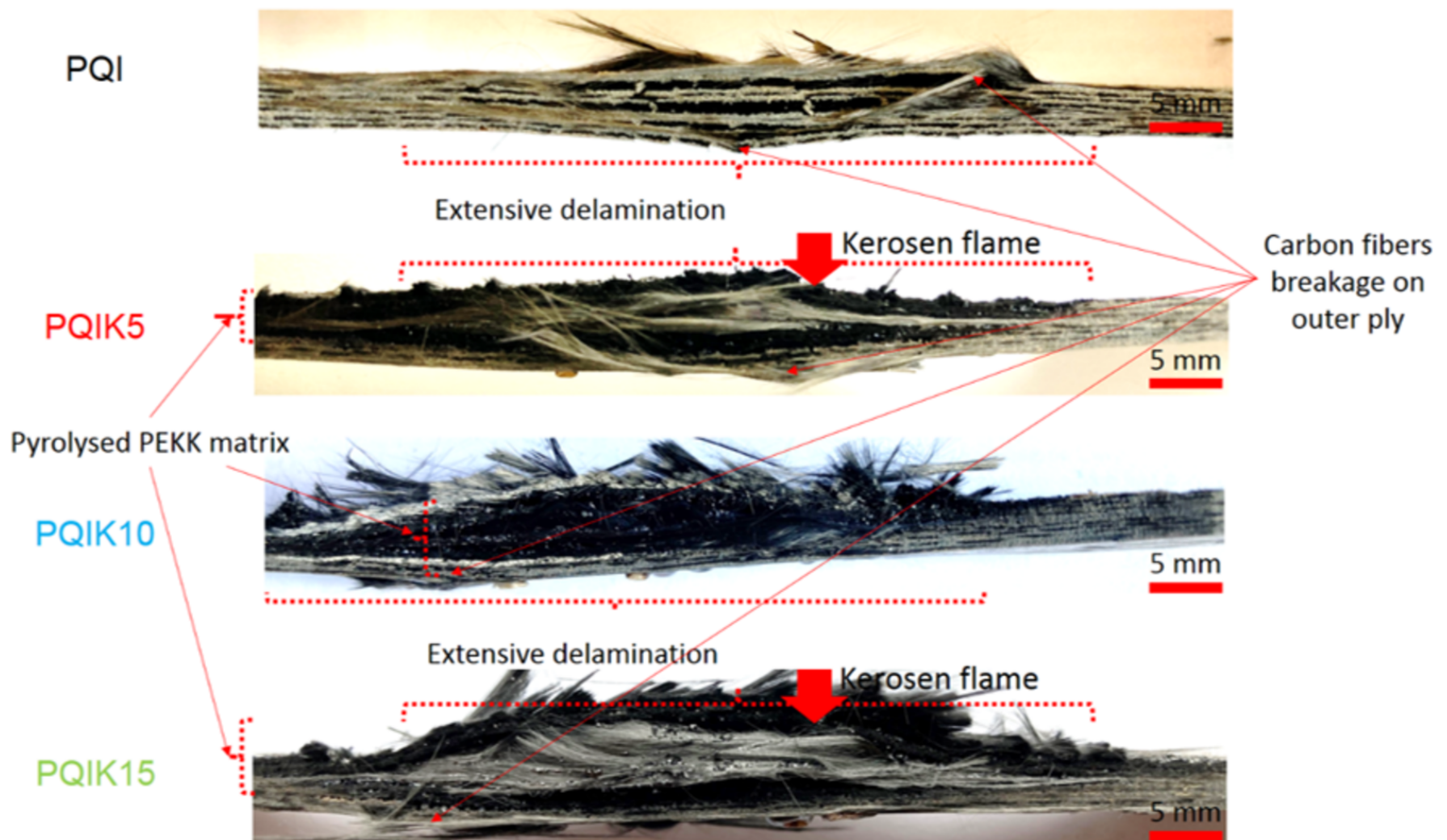
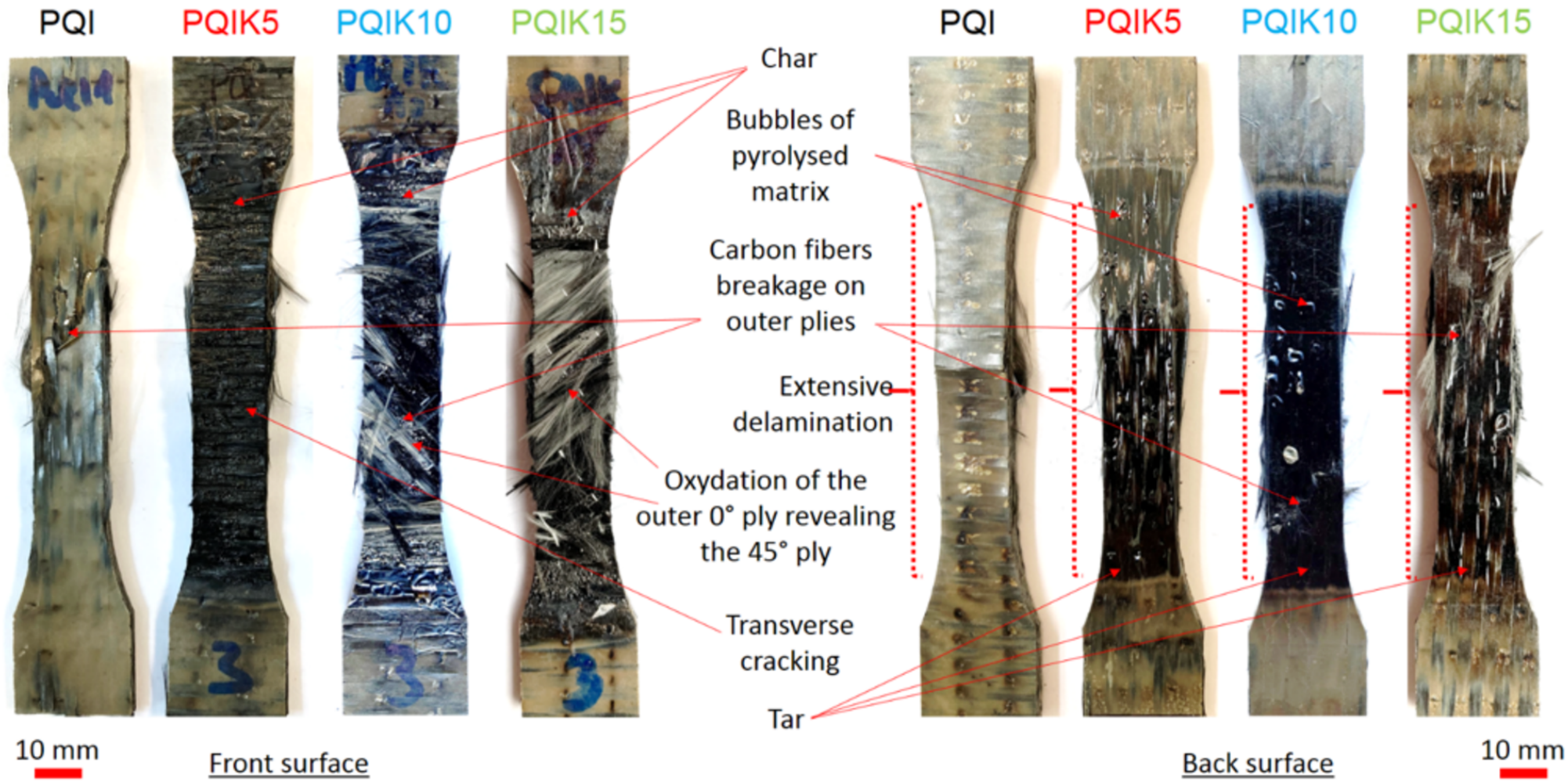

Tables

	E_x (Gpa)	σ_x^u (Mpa)
Virgin	127.2±3.5	598±1
5 min	107.3±4.4	274±25
10 min	98.9±5.4	278±24
15 min	92.3±4.4	241±28
Influence of exposure time	-27%	-59%

Tab. 1 – Influence of exposure time on the residual tensile properties of orthotropic laminates subjected to a kerosene flame

	E_x (Gpa)	σ_x^u (Mpa)
Virgin	51.3±0.5	231±34
5 min	44.9±2.0	168±14
10 min	46.0±3.0	163±33
15 min	41.8±2.2	164±21
Influence of exposure time	-22%	-40%

Tab. 2 – Influence of exposure time on the residual tensile properties of quasi-isotropic laminates subjected to a kerosene flame