



HAL
open science

Optimization of La (III) extraction by nanofiltration

Boutheyna Aoufi, Mohamed Didi, Didier Villemin

► **To cite this version:**

Boutheyna Aoufi, Mohamed Didi, Didier Villemin. Optimization of La (III) extraction by nanofiltration. Scientific Study and Research: Chemistry and Chemical Engineering, Biotechnology, Food Industry, 2020, XXI (1), pp.95-110. hal-02889849

HAL Id: hal-02889849

<https://normandie-univ.hal.science/hal-02889849>

Submitted on 5 Jul 2020

HAL is a multi-disciplinary open access archive for the deposit and dissemination of scientific research documents, whether they are published or not. The documents may come from teaching and research institutions in France or abroad, or from public or private research centers.

L'archive ouverte pluridisciplinaire **HAL**, est destinée au dépôt et à la diffusion de documents scientifiques de niveau recherche, publiés ou non, émanant des établissements d'enseignement et de recherche français ou étrangers, des laboratoires publics ou privés.

OPTIMIZATION OF La (III) EXTRACTION BY NANOFILTRATION

Boutheyna Aoufi¹, Mohamed Amine Didi^{1*}, Didier Villemin²

*¹Tlemcen University, Faculty of Sciences, Department of Chemistry,
Laboratory of Separation and Purification Technologies, Tlemcen, Algeria*

*²Laboratoire de Chimie Moléculaire et Thioorganique, UMR CNRS 6507,
INC3M, FR 3038, Labex EMC3, ENSICAEN, 14050 Caen, France*

Abstract: This study investigates the capacity of polyamide nanofiltration membrane (SNTE NF270-2540) to extract the lanthanum (La) (III) and its mixtures with the iron (Fe) (III). A three - level factorial design and response surface methodology was used to evaluate the effects of different parameters, such as: *pH* (3.0 – 9.0), concentration (10 – 100 ppm), pressure (6.0 – 13.5 bars). The results showed that the retention of La (III) varied from 29 % to 100 %, depending on the experimental condition it was possible to extract all of La (III) and Fe (III) from the same mixture. The results showed that the extraction of La (III) reaches 100 % for 10 and 55 ppm at *pH* = 3.0 and for 100 ppm at *pH* = 9.0, under the pressure of 13.5 bars. At *pH* = 3.0, the extraction of the mixtures La (III) / Fe (III) (50 ppm / 50 ppm) and (100 ppm / 100 ppm) whatever the pressure was all (100 %). The study confirmed a high lanthanum extraction using polyamide nanofiltration membrane.

Keywords: *extraction, iron, lanthanum, nanofiltration, optimization*

INTRODUCTION

In the modern life rare earth elements (RE) have become important due to their properties, which are essential in nuclear energy, chemical engineering and metallurgy [1 - 4]. From all the RE elements, lanthanum is the most widely used [5, 6].

There are many conventional methods for removing and extraction lanthanum from aqueous solution, such as: solvent extraction [7, 8], chemical precipitation [9], adsorption [10 – 12], electrochemical treatment [13], and membrane filtration [14, 15].

The nanofiltration membrane technique has been found to be an attractive method for the concentration and separation of different solutes [16]. In nanofiltration electro migration, diffusion and convection are the major mechanisms of transport [17].

The aim of this research was to study the retention of lanthanum and its mixtures with iron, by using the SNTE NF270-2540. The effects of feed solution *pH*, pressure and feed solution concentration on the membrane performance were studied.

MATERIALS AND METHODS

Materials

A commercially spiral nanofiltration membrane SNTE NF270-2540 supplied by DOW FILMTEC™ Membranes (USA) was used in this study. All the experimental conditions of this membrane are summarized in Table 1.

Table 1. Main characteristics of the NF membrane used

Membrane structural parameters	
Membrane type	thin-film composite
Active area	2.6 m ²
Maximum operating temperature	113 °F (45°C)
Maximum operating pressure	600 psi (41 bar)
<i>pH</i> range	2 - 11
Free chlorine tolerance	< 0.1 ppm
Water permeability L _p (m·s ⁻¹ ·bar ⁻¹)	0.366 x 10 ⁻⁶

Lanthanum nitrate salt was supplied by Carlo Erba (France), iron nitrate, nitric acid (69 %) and sodium hydroxide were purchased from Sigma-Aldrich (Germany). Arzenazo (III) was supplied by MERCK (Germany).

The predominance of La (III) according to the *pH* was made by the Medusa software.

All solutions were prepared by dissolving the appropriate weight of the salt in water and made to a volume of 40 L.

Analyses

Lanthanum ion concentration was measured by a UV-Visible spectrophotometer type (SPECORD 210/plus) purchased by Analytik Jena Specord (Germany), takings of 100 µL of lanthanum are measured by UV-VISIBLE after the addition of 2 mL of stamp solution with *pH* = 4 and 100 µL of Arzenazo III.

Iron ion concentration was determined by atomic absorption spectrophotometer (PINA CLE 900 H - Perkin Elmer, USA), at Tlemcen Algeria, using an air acetylene flame, the wavelength used: 248.33 nm. A range of standards solutions for various concentrations were prepared.

The pH value was measured with a pH - meter AD 1030 (Adwa, Hungary). The weighing was made with an electronic analytical balance type OHAUS (USA).

Experimental setup and methods

Nanofiltration experiments were carried out with the separation unit illustrated in Figure 1. The meaning of the abbreviations used in Figure 1:

All experiments were performed for applied pressures in the range of 6 - 13.5 bars, after each experiment the membrane was cleaned for 15 min with $0.754 \text{ mmol}\cdot\text{L}^{-1}$ hydrochloric solutions. CA is the cartridge filter with activated carbon and $25 \mu\text{m}$ of wound cartridge filter. S is the safety valve (14 bars). B1 is the feed tank (100 L). B2 is the permeate tank (20 L). C2 is the nanofiltration membrane. FI1 is the upstream flow meter (100-1000 l/h). FI2 is the downstream flow meter of retentive. FI3 is the downstream flow meter of permeate. PI1 & PI2 are the manometers at upstream and downstream of module (0-16 bars). PI3 & PI4 are the monitoring manometers of filters state (0–2.5 bars). LSL1 is the low level sensor (pump safety). CE1 is the sensor of permeate conductivity measuring. Y is the emptying, CIT1 to the electrical display cabinet. V1–5, 7, 10, 11, 14-16, 19 & 22 are the pressure regulation valves for nanofiltration process. P is the multistage centrifugal pump (high pressure).

In all experiments both permeate solution and retentive solution were returned to the feed tank.

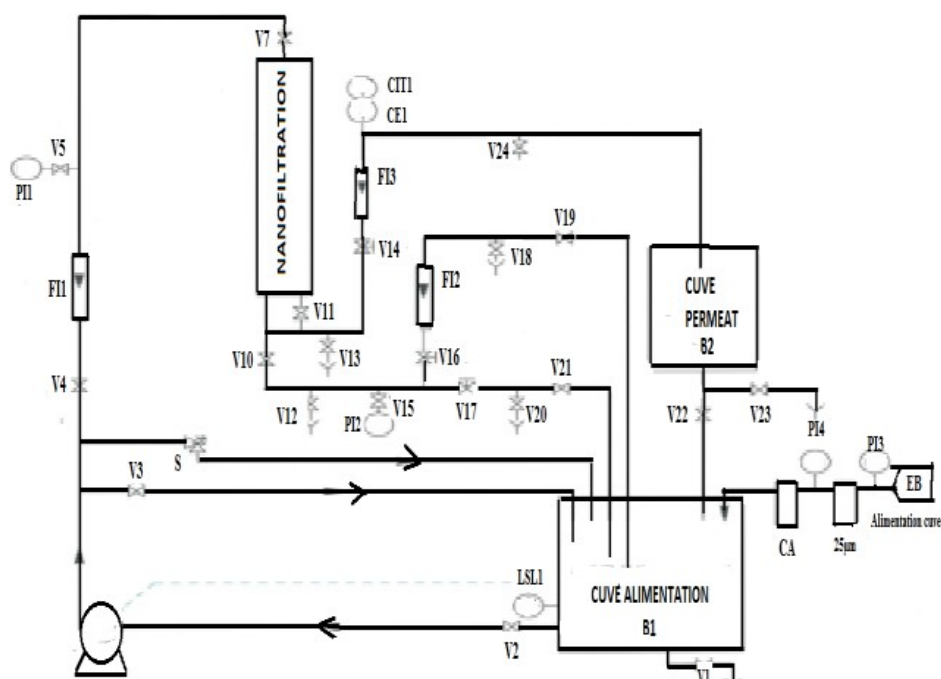

Figure 1. Experimental setup

Data analysis

The extraction yield was calculated by Eq (1):

$$Y (\%) = \left(1 - \frac{C_p}{C_0}\right) \times 100 \quad (1)$$

where:

C_p : represent the permeate solution concentration (ppm),

C_0 : represent the feed solution concentration (ppm).

RESULTS AND DISCUSSION

Effect of pH

The pH effect has been studied for lanthanum feed solution at 10 - 100 ppm feed solutions and for 50 - 100 ppm lanthanum iron equimolar mixtures at pH 3.0 - 9.0 and by varying the pressure between 6.0 and 13.5 bars.

According to the medusa software in Figure 2, the lanthanum ion is predominant in its free form at pH between 0.0 and 7.6 for the different concentrations, the maximum fraction is 100 %, so when the pH becomes greater than 7.6, this fraction reaches a minimal value. The slight presence of $\text{La}(\text{OH})_2^+$ in the pH between 6.5 and 8.7, while the $\text{La}(\text{OH})_3$ hydroxide appears at pH between 7.7 and 14 its fraction 100 % at pH = 9.1. Positively charged La (III) species will be transported and ejected away from the membrane as ion pairs whose nitrate is the counter-ion.

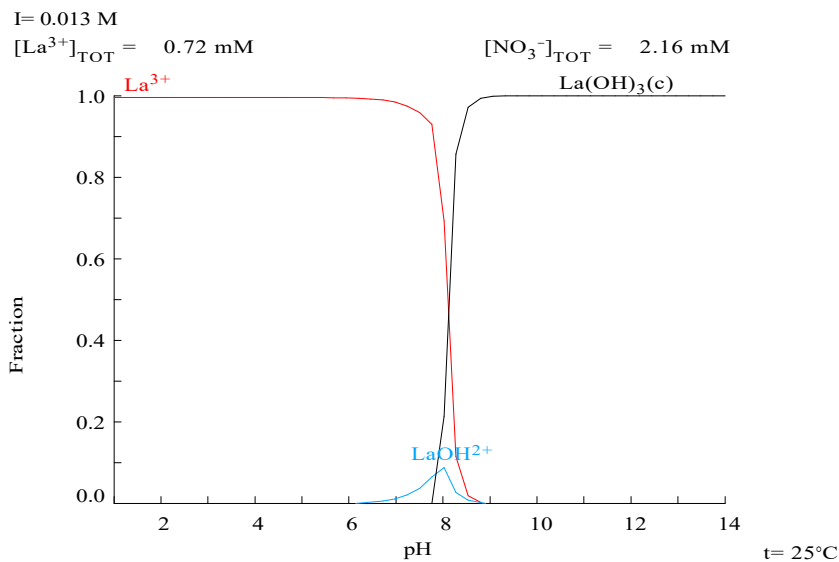

Figure 2. Diagrams of La (III), distribution using Medusa program [18]

Figure 3 shows the influence of the feed pH on the retention of lanthanum ions, and it is noted that for a concentration of 10 and 55 ppm, the retention of lanthanum at pressure 9.75 bars increases from 90 % to 100 % with the increase of pH from 3 to 6.

For the concentration of 100 ppm, the rejection increase from 95 to 100 % when the pH increases from 3.0 to 9.0 whatever the pressure.

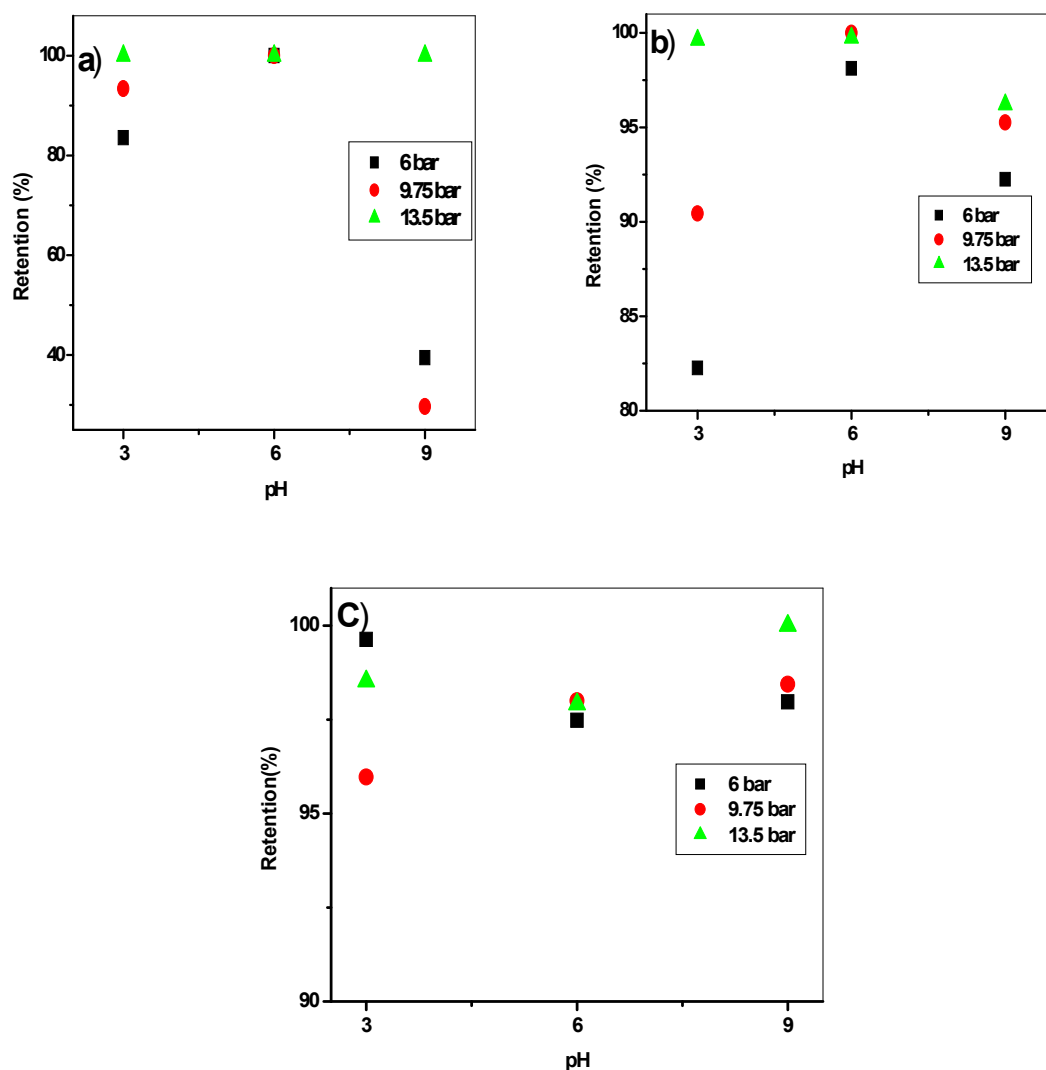

Figure 3. Variation of lanthanum retention according to the pressure for different pH
a) $[La^{+3}]_0 = 10$ ppm b) $[La^{+3}]_0 = 55$ ppm c) $[La^{+3}]_0 = 100$ ppm

Figure 4 shows that for pressure between 6 and 13.5 bars, the retention of lanthanum in mixture of 50 ppm varies from 98 % to 100 % and was quantitative (100 %) for iron at different pH values.

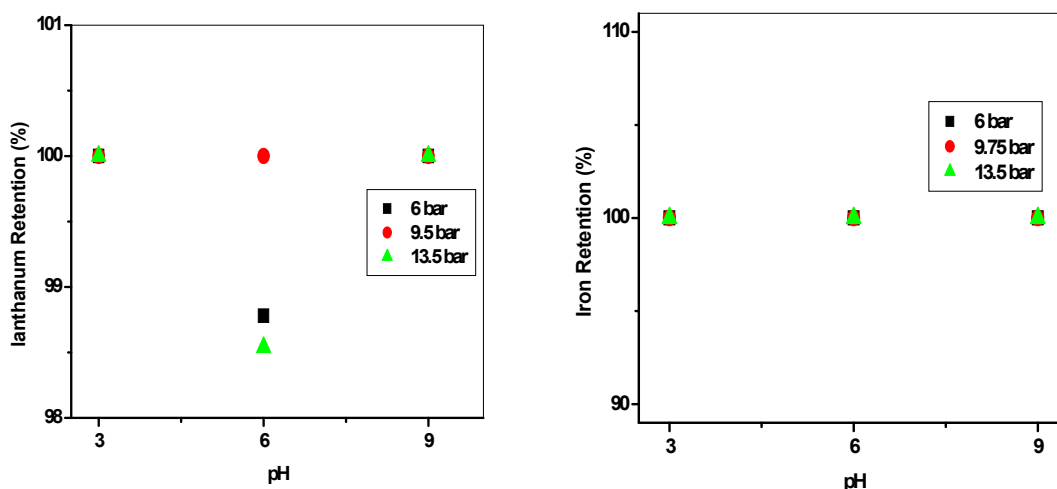

Figure 4. Variation of lanthanum and iron retention according to the pressure for different pH, $[La^{3+}] = [Fe^{3+}] = 50$ ppm

It is noted from Figure 5, that the lanthanum retention decreases from 100 % to 90 % at 6 bars for pH 3 - 6 and increasing from 90 % to 96 % for pH range from 6 - 9. Iron retention increases from 90 % to 98 % with the increase of pH.

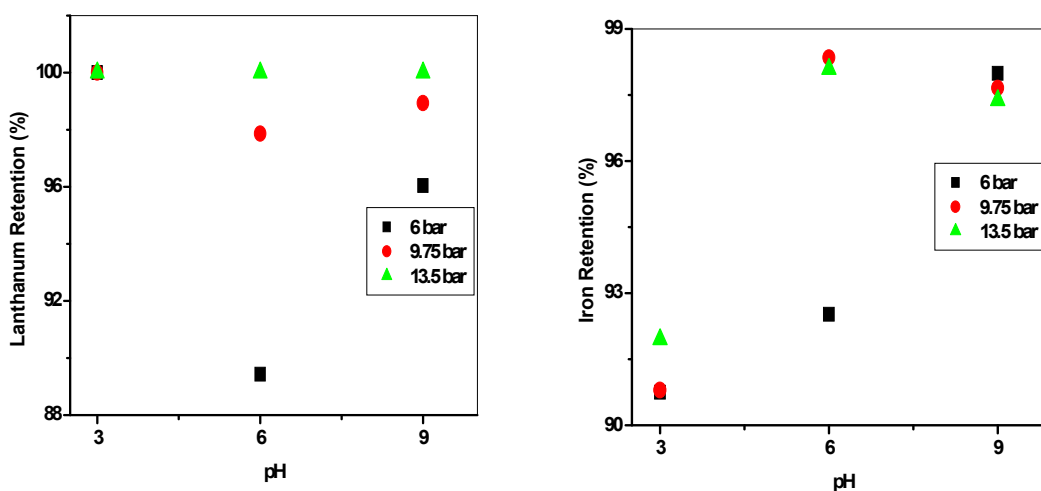

Figure 5. Variation of lanthanum and iron retention according to the pressure for different pH, $[La^{3+}] = [Fe^{3+}] = 80$ ppm

In view of Figure 6, the retention of lanthanum decreases when the pH varies from 3 - 6 whatever the admissible pressure (from 6 to 13.5 bars), then increases with the increase in pH. Figure 6 shows also that whatever the permissible pressure (from 6 to 13.5 bars) and whatever the pH, the retention of iron is total (100 %). The membrane extracts the mixture without distinction between iron and lanthanum, although these two metals have different physicochemical properties.

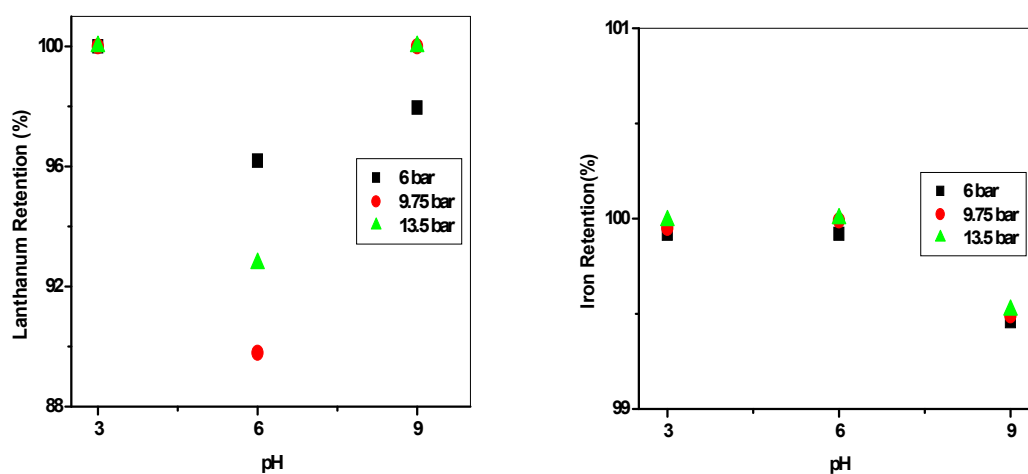

Figure 6. Variation of lanthanum and iron retention according to the pressure for different pH, $[La^{3+}] = [Fe^{3+}] = 100$ ppm

This result can be explained by the decrease in the NF270-2540 membrane pore size when the pH increase, due to the dissociation of the carboxyl (-COOH) and ammonium (-NH₃⁺) membrane groups and the electrostatic repulsion between them, which leads to an increase in the rejection of the solute [19 – 21].

Membranes easily rejected these hydroxides and therefore the lanthanum ion rejection will be greater.

Effect of concentration

From Figure 7a, it can be seen that the retention of the solutions decreases (83 - 82 %, 93 - 90 % at 6.0 and 9.75 bars respectively) when the concentration increases from 10 ppm to 55 ppm and then increases (82 - 95 %, 90 - 98 % at 6.0 and 9.75 bars respectively) with increasing concentration from 55 ppm to 100 ppm

In Figure 7b it can be seen that the retention of the solutions decreases with the increase of the concentration. These results can be attributed to the concentration polarization phenomenon, which tends to reduce the flow of the permeate and consequently the decrease of metals ions retention by membrane [22]. This can also be explained by the neutralization of the negative sites of the membrane due to the increase of the positive charges [23].

The results obtained in Figure 7c show that the retention increases (39 - 97 %, 29 - 98 % at 6 and 9 bars respectively) with increasing concentration. At 13.5 bars the lanthanum extraction yield decreases from 100 % to 96 % as the concentration of the feed solution increases from 10 ppm to 55 ppm, then becomes quantitative (100 %) in the solution of 100 ppm. These results are in agreement with the literature in the case of zinc [24] and chromium [25].

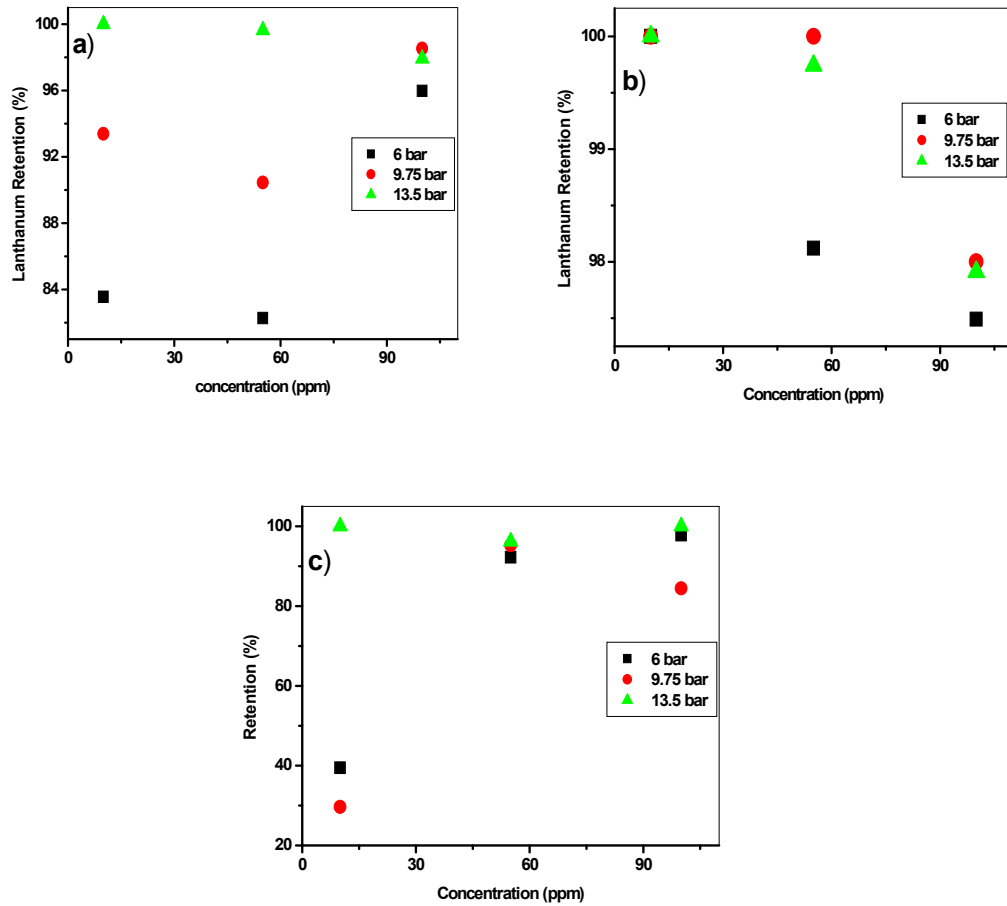

Figure 7. Variation of lanthanum retention according to the pressure for different concentrations at a) $pH = 3.0$, b) $pH = 6.0$, c) $pH = 9.0$

The results obtained in Figure 8 show that the retention of La (III) is total (100 %) for the various mixtures of iron and lanthanum.

For a pressure range of 6.0 to 13.5 bars the retention of iron (III) decreased with increasing concentration from 50 ppm to 80 ppm and increases as the concentration increases from 80 ppm to 100 ppm. The extraction of all lanthanum and iron is possible in the mixtures of 50 ppm and 100 ppm under the pressure of 6.0 bars.

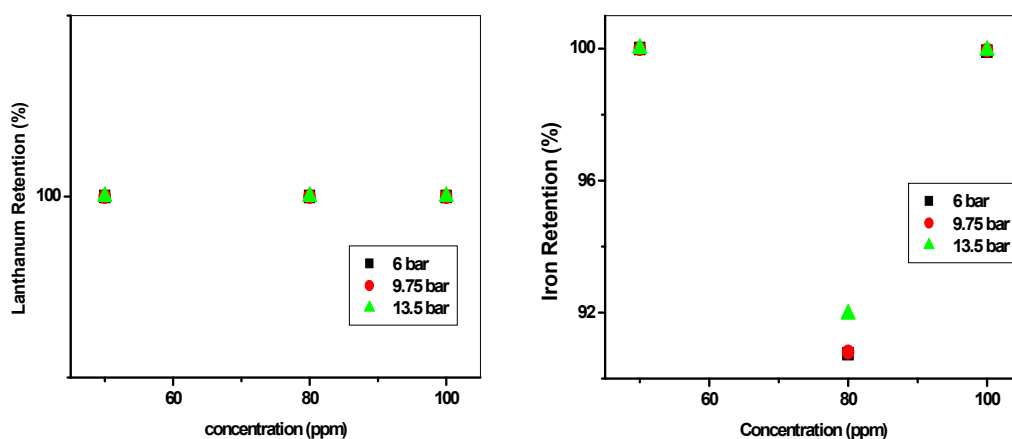

Figure 8. Variation of lanthanum and iron retention according to the pressure for different concentrations at $pH = 3.0$

From Figure 9, for pressure variations from 6.0 to 13.5 bar, it is noted that the retention of lanthanum is quantitative for a pressure of 9.75 bars for the mixture of 50 ppm and in the mixture of 80 ppm at 13.5 bars. In the mixture of 100 ppm the lanthanum retention decreases with the increase of pressure. The polarization of concentration can explain the decrease in retention with the increase in pressure [17]. The iron retention was 100 % whatever the pressure supplied to mixtures of 50 and 100 ppm. The retention increases of 92 - 98 % with the increase of the pressure in the mixture of 80 ppm.

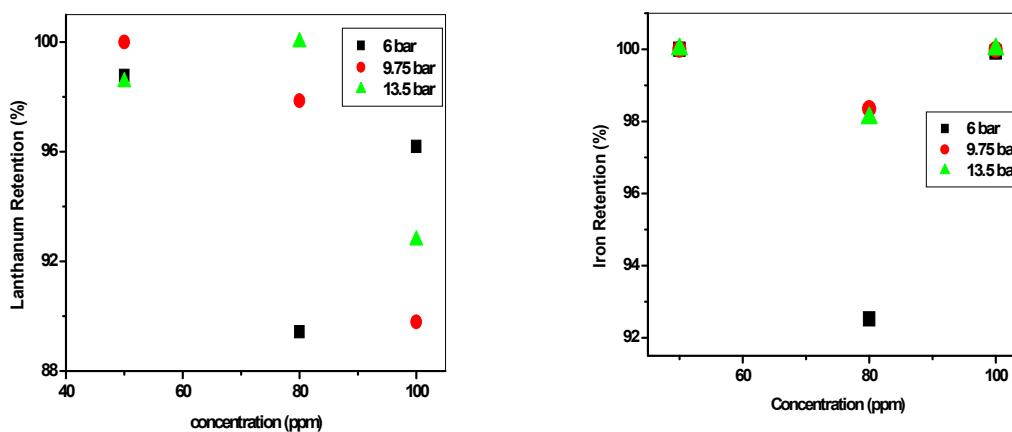

Figure 9. Variation of lanthanum and iron retention according to the pressure for different concentrations at $pH=6.0$

Figure 10 shows that at 13.5 bars the retention of lanthanum was quantitative (100 %) whatever the concentration of the mixture, in the mixture of 80 ppm the retention of lanthanum increases with the increase in pressure. The iron retention was quantitatively exceptional for the mixture of 80 ppm of the pressure (6.0 and 13.5 bars). The rejection by the membrane will be done with electrostatic (negative charged complex) and steric exclusion [26].

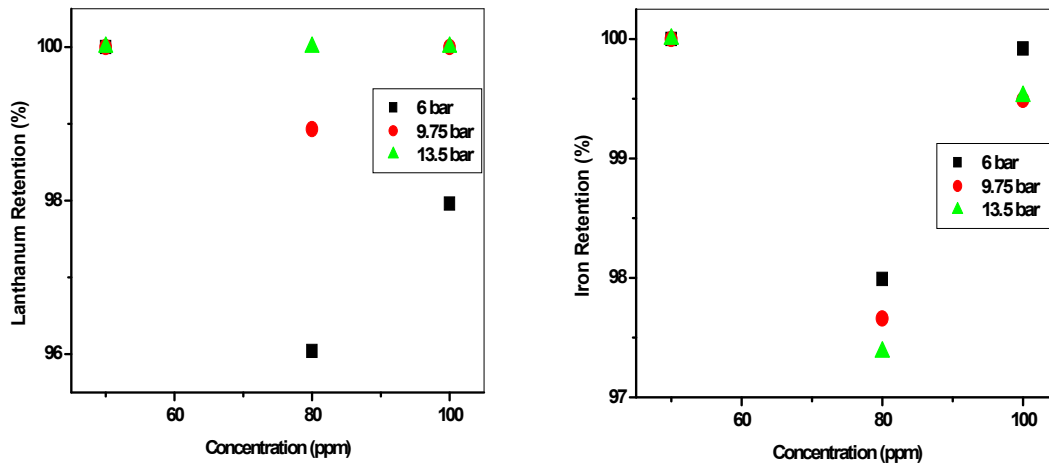

Figure 10. Variation of lanthanum and iron retention according to the pressure for different concentrations at pH=9.0

Factorial design study

The study results of the extraction of lanthanum (III) by nanofiltration according to three variables: concentration C, pressure P and pH, these variables is represented in terms of the extraction yield value by the response Y. These results are subjected to an empirical smoothing. In this method, the experimental values can be used to determine the polynomial model constants, which follow the (Equation 2). Equation 2 is adjusted to the studied properties variations.

The analysis of the twenty-seven experimental designs allows to building 3³ factorial design matrixes and the responses (see Table 2).

Preliminary observations show that according to the experiment parameters the extraction yield of lanthanum was significant, reaching values of 29.65 - 100 % under certain operating conditions (Table 2). This correlation allows building the response surface.

The results of the experimental tries are also presented in the Table 2.

The lanthanum (III) modeling was achieved on the basis of the eleven measured values using (Equation 2):

$$Y(\%) = a_0 + a_1X_1 + a_2X_2 + a_3X_3 + a_{12}X_1X_2 + a_{13}X_1X_3 + a_{23}X_2X_3 + a_{11}X_1^2 + a_{22}X_2^2 + a_{33}X_3^2 + a_{123}X_1X_2X_3 \quad (2)$$

where: X_j ($j = 1-3$) reduced variable which takes three values: -1 (low level), 0 in the middle and +1 (high level); low level = 2 (low value-mean)/range; high level = 2 (high value-mean)/range; mean= (high value + low value)/2; range = (high value-low value). X_1 , X_2 & X_3 are the reduced variables of pH, concentration (C), and pressure (P), respectively.

Table 2. 3^3 factorial design matrixes and the responses

No	Real values			Reduced values			Extraction yield (Z %)
	pH	C	P	X ₁	X ₂	X ₃	
1	3	10	6	-1	-1	-1	83.54
2	3	10	9.75	-1	-1	0	93.38
3	3	10	13.5	-1	-1	+1	100
4	3	55	6	-1	0	-1	82.26
5	3	55	9.75	-1	0	0	90.44
6	3	55	13.5	-1	0	+1	99.63
7	3	100	6	-1	+1	-1	95.97
8	3	100	9.75	-1	+1	0	98.52
9	3	100	13.5	-1	+1	+1	97.92
10	6	10	6	0	-1	-1	100
11	6	10	9.75	0	-1	0	100
12	6	10	13.5	0	-1	+1	100
13	6	55	6	0	0	-1	98.12
14	6	55	9.75	0	0	0	100
15	6	55	13.5	0	0	+1	99.74
16	6	100	6	0	+1	-1	97.48
17	6	100	9.75	0	+1	0	98.00
18	6	100	13.5	0	+1	+1	97.91
19	9	10	6	+1	-1	-1	39.45
20	9	10	9.75	+1	-1	0	29.65
21	9	10	13.5	+1	-1	+1	100
22	9	55	6	+1	0	-1	92.25
23	9	55	9.75	+1	0	0	95.26
24	9	55	13.5	+1	0	+1	96.91
25	9	100	6	+1	+1	-1	97.79
26	9	100	9.75	+1	+1	0	98.44
27	9	100	13.5	+1	+1	+1	100
(28,29,30) ^a	6	55	9.75	0	0	0	90.87,97.23,94.48

Note: ^aFour additional tests at the central point (0, 0, 0) for the calculation of the Student's and Fisher's test

Table 3 summarizes the coefficient values of the model, supposed to describe the individual effects of parameters, along with their possible interaction.

The individual effects of the parameters and their interactions were discussed on the basis of the sign and the absolute value of each coefficient. These coefficients will define the strength of the corresponding effect involved and the way it acts upon yield extraction (favorable or detrimental), respectively.

The first observations in Table 3 make it possible to formulate the following statements:

- High extracting capacity of the lanthanum ought to be obtained within the fixed parameter ranges, justifying there by the suitable choice of the limits.
- The favorable individual effect of lanthanum feed concentration is stronger than the favorable individual effect of pressure, while the pH of the feed solution appears to play only one weak negative role in the survey ranges.

- iii. Except between pH and lanthanum (III) concentration, and between pH and pressure and all interactions are harmful.
- iv. No synergy should be implied by the three parameters.

Table 3. Model coefficients and their corresponding effects upon yield extraction

Variable	Coefficient	Value	Expected effect on the yield extraction
X ₀	a ₀	99.32	High average extracting capacity of the nanofiltration
X ₁	a ₁	-05.08	Detrimental individual effect of pH
X ₂	a ₂	07.57	Favorable individual effect of C
X ₃	a ₃	05.84	Favorable individual effect of P
X ₁₂	a ₁₂	09.32	Favorable binary interaction of pH and C
X ₁₃	a ₁₃	02.62	Favorable binary interaction of pH and P
X ₂₃	a ₂₃	-06.05	Detrimental binary interaction of C and P
X ₁₁	a ₁₁	-10.32	Detrimental binary interaction of pH and pH
X ₂₂	a ₂₂	-04.46	Detrimental binary interaction of C and C
X ₃₃	a ₃₃	4.021	Favorable binary interaction of P and P
X ₁₂₃	a ₁₂₃	-05.50	Ternary detrimental interaction

Table 4. Analysis of the variance

Feature	Symbol/Equation	Value
Parameter number	P	3
Level number	L	3
Number of experimental	N	27
Number of tests at (0,0,0)	n	3
Model variance	v	2
Average yield at (0,0,0)	$Z_0 = \sum Z_{0i} / 3$	94.19
Random variance	$S^2 = \sum (Z_{0i} - Z_0)^2 / v$	10.17
Square root of variance	S	3.18
Risk factor (chosen arbitrary)	α	0.05 (95 %) ^a
Student test factor	T _{v, 1-α/2}	4.3 ^b
Average error on the coefficient value (trust range)	$\Delta a_i = \pm t_{v, \alpha/2} S / N^{0.5}$	2.64
Number of remaining coefficients	R	11
Model response at (0,0,0)	a ₀ (Z ₀₀₀)	99.33
Discrepancy on average yield	d = Z ₀ - Z (0,0,0) = Z ₀ - a ₀	5.13
Error on average yield discrepancy	$\Delta d = \pm t_{v, \alpha/2} S (1/N + 1/n)^{0.5}$	8.35
Average yield for the 27 attempts	with N = 27 & n = 3 $Z_m = \sum Z_i / 27$	91.95
Residual variance	$Sr^2 = \sum (Z_i - Z_m)^2 / (N - R)$	351.45
Degrees of freedom	v ₁	10
Residual degrees of freedom	v ₂	2
Observed Fisher test	F _{obs} = Sr ² / S ²	34.54
Fisher-snedecor law	F _{obs, v₁, v₂}	19.4 ^c

a. α = 5% was arbitrary chosen, in this case, one regarded that 95% confidence may be satisfactory.

b. student tables with two degrees of freedom at a 95% confidence, t_{crit} (2; 0,05).

c. see Fisher-snedecor tables, F_{crit} = 19.4.

In order to precede the validation of the model, have been estimated the experimental error on the results, to be able to make that was used the results obtained from the resolution of the matrix system. For this purpose, have been repeated three times the

experience of the central (Table 2) by using the test of Student in the level $(1-\alpha)$ with $\alpha = 0.05$ (Table 4).

The variance σ for three repeated experiences is equal to 10.17 and the test of Student is estimated, being equal to 2.64, have been neglected all the coefficients absolute value of which is lower than 2.64. Consequently, no coefficient will be removed from the mathematical model, the equation with variables coded becomes as follows:

$$Y(\%) = 99.32 - 5.08X_1 + 7.57X_2 + 5.84X_3 + 9.32X_1X_2 + 2.65X_1X_3 - 6.05X_2X_3 - 10.62 X_{11} - 4.47X_{22} - 4.02 X_{33} + 5.50X_1X_2X_3 \quad (3)$$

The test of Fisher was applied to verify the validity of the model in the range of examined parameters. The calculation showed that the test of Fisher observed (35.54) is higher than the test of critical Fisher (19.37), indicating that the model can be applied in the completely examined range.

Surface response

Figures 11, 12 and 13 show the graphs of surface response of lanthanum extraction and the effects of the different factors on its efficiency.

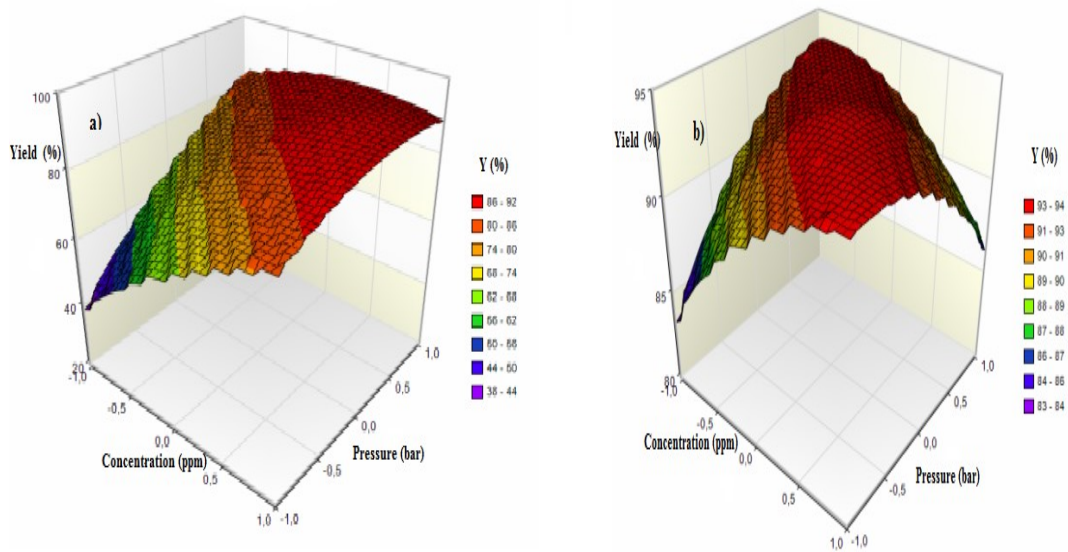

Figure 11. Three-dimensional isometric response curves at fixed pH:
(a) $X_1 = +1$, (b) $X_1 = -1$

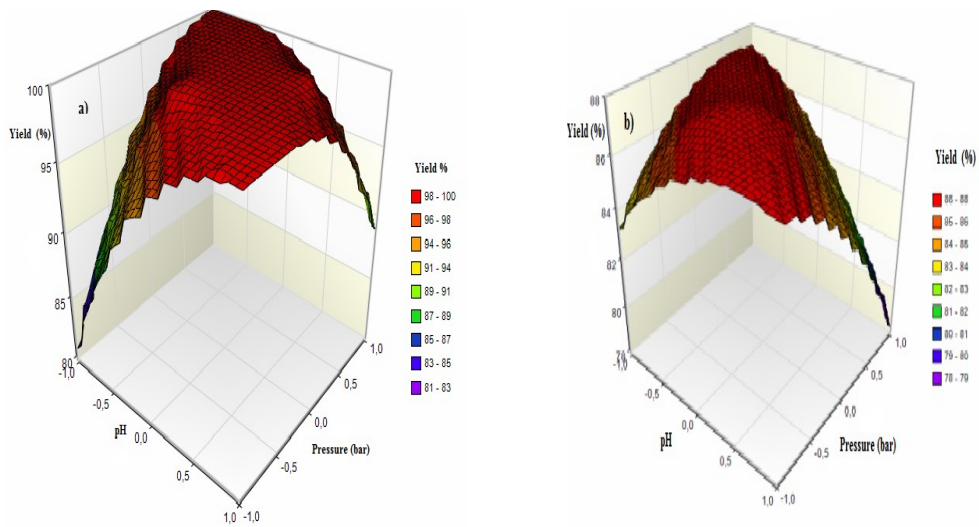

Figure 12. Three-dimensional isometric response curves at fixed concentration: (a) $X_2 = +1$, (b) $X_2 = -1$

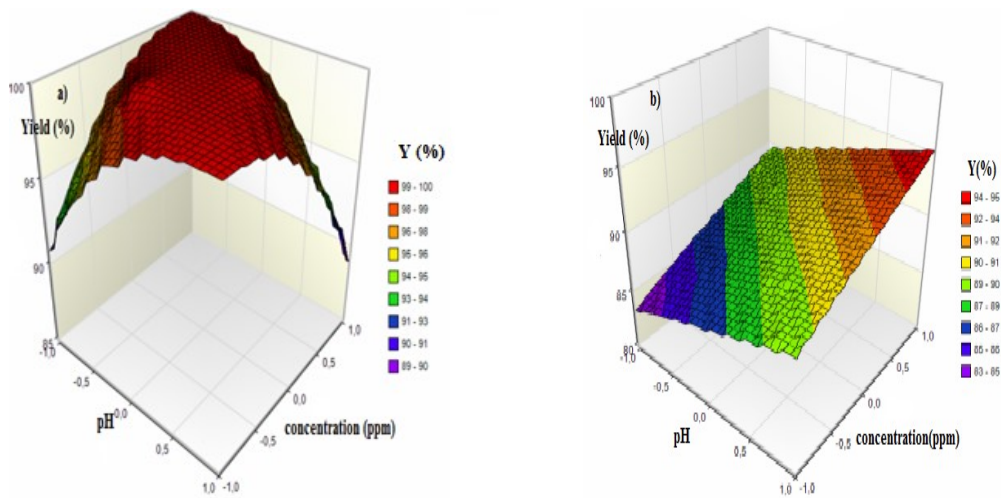

Figure 13. Three-dimensional isometric response curves at fixed pressure: (a) $X_3 = +1$, (b) $X_3 = -1$

CONCLUSION

This study describes the performance of the SNTE NF270-2540 thin-film composite polyamide nanofiltration membrane in the extraction and the separation of lanthanum ions and its mixture with iron ions from synthetic solutions. For pressure between 6 and 13.5 bars; the retention of lanthanum in mixture of 50 ppm varies from 98 % to 100 % and was quantitative (100 %) for iron at different pH values.

The factorial designs made it possible to optimize a procedure for the extraction of lanthanum (III) based on nanofiltration membrane.

The experimental design is a way to study the influence of a parameter, to evaluate its individual effect, binary interactions and its possible synergy with other variables when acting simultaneously.

In order to obtain the best experimental conditions for the extraction of La (III) by nanofiltration from aqueous solution full 3³ factorial designs were used to screen the factors that would influence the overall optimization of a procedure of extraction.

Individual effect of lanthanum concentration is favorable, but her combined effect with pressure became detrimental.

This optimization showed that the best initial conditions were lanthanum (III) concentration equal to 10 ppm, initial pH= 6.0, and pressure equal to 6 bars with extraction yield of 100 %.

The results obtained in this study make the nanofiltration as promising processes for extraction, separation and pre-concentration of heavy metal ions and rare earth elements.

ACKNOWLEDGEMENT

We gratefully acknowledge the DGRSDT and ATRST- Algeria for the financial support.

REFERENCES

1. Kadous, A., Meddour-Boukhobza, L., Didi, M.A., Villemin, D.: Synthesis and characterization of TOPO and HDADMDPA. Application in Uranium (VI) extraction, *Scientific Study & Research - Chemistry & Chemical Engineering, Biotechnology, Food Industry*, **2009**, 10 (3), 213-226;
2. Naït-Tahar, S., Didi, M.A., Villemin, D.: CPE of Uranium (VI) using ionic liquid, *Scientific Study & Research - Chemistry & Chemical Engineering, Biotechnology, Food Industry*, **2016**, 17 (2), 211-218;
3. El Habiri, S.A., Didi, M.A.: Design optimization of extraction procedure for Terbium (III) by supported liquid membrane using D2EHPA and TOPO as a carrier, *Scientific Study & Research - Chemistry & Chemical Engineering, Biotechnology, Food Industry*, **2018**, 19 (2), 143-155;
4. Boulenouar, I., Kaid, M., Abbes, O., Villemin, D.: Solvent extraction of lanthanum (III) and europium (III) from nitrate media by aminooctyldimethylene diphosphonic acid, *Solvent Extraction Research and Development*, **2016**, 23, 51-61;
5. Benaïssa, E., Abderrahim, O., Didi, M.A.: Comparative study on lanthanum (III) sorption onto Lewatit TP 207 and Lewatit TP 260, *Journal of Radioanalytique and Nuclear Chemistry*, **2014**, 299, 439-446;
6. Bendiaf, H., Abderrahim, O., Villemin, D., Didi, M.A.: Studies on the feasibility of using a novel phosphonate resin for the separation of U (VI), La (III) and Pr (III) from aqueous solutions, *Journal of Radioanalytique and Nuclear Chemistry*, **2017**, 312, 587-597;
7. Saleh, M.I., Fazlu, M.D., Bari, B.S.: Solvent extraction of lanthanum (III) from acidic nitrate-acetato medium by Cyanex 272 in toluene, *Hydrometallurgy*, **2002**, 63, 75-84
8. Wu, D., Niu, C., Li, D., Bai, Y.: Solvent extraction of scandium(III), yttrium(III), lanthanum(III) and gadolinium(III) using Cyanex 302 in heptane from hydrochloric acid solutions, *Journal of Alloys and Compounds*, **2004**, 374, 442-446;
9. Tokunaga, S., Yokoyama, S., Wasay S.A.: Removal of arsenic(iii) and arsenic(v) ions from aqueous solutions with lanthanum(iii) salt and comparison with aluminum(iii), calcium(ii), and iron(iii) salts, *Water Environment Research*, **1999**, 71, 299-306;

10. Sepehrian, H., Cheraghali, R., Rezaei, P., Abdi, H.A.: Adsorption behavior of lanthanum on modified nanoporous aluminosilicates, *International Journal of Industrial Chemistry*, **2011**, 2 (4), 235-241;
11. Bagheriyan, S.: Facile and efficient method for the adsorption and separation of lanthanum rare earth metal oxide using iron(II) sulfide nanoparticles coated on magnetite, *Journal of Chemistry and Chemical Engineering*, **2011**, 9, 824-827;
12. Chen, Y., Zhu, C., Sun, Y., Duan, H., Ye, W., Wu, D.: Adsorption of La (III) onto GMZ bentonite: effect of contact time, bentonite content, pH value and ionic strength, *Journal of Radioanalytique and Nuclear Chemistry*, **2012**, 292, 1339-1347;
13. Martinot, L., Lopes, L., Marien, J., Jérôme, C.: Electrochemistry of lanthanum and uranium chlorides in organic media: Deposition of lanthanum and uranium, *Journal of Radioanalytique and Nuclear Chemistry*, **2002**, 253, 407-412;
14. Chitry, F., Garcia, I.R., Nicod, L., Gass, J.L., Madic, C., Lemaire, M.: Separation of gadolinium(III) and lanthanum(III) by nanofiltration-complexation in aqueous medium, *Journal of Radioanalytique and Nuclear Chemistry*, **1999**, 240, 931-934;
15. Chitry, F., Pellet-Rostaing, S., Gozzi, C., Lemaire M.: Separation of lanthanides (iii) by nanofiltration-complexation in aqueous medium, *Separation Science and Technology*, **2001**, 36 (4), 605-618;
16. Mehdipour, S., Vatanpour, V., Kariminia, H.R.: Influence of ion interaction on lead removal by a polyamide nanofiltration membrane, *Desalination*, **2015**, 362, 84-92;
17. Tansel, B., Sager, J., Rector, T., Garland, J., Strayer, R.F., Levine, L., Roberts, M., Hummerick, M., Bauer, J.: Significance of hydrated radius and hydration shells on ionic permeability during nanofiltration in dead end and cross flow modes, *Separation and Purification Technology*, **2006**, 51, 40-47;
18. Puigdomenech I (2006) MEDUSA (Make Equilibrium Diagrams Using Sophisticated Algorithms) Program, Royal Institute of Technology Stockholm On line at <http://www.kemi.kth.se/medusa/>;
19. Gherasim, C.V., Mikulasek, P.: Influence of operating variables on the removal of heavy metal ions from aqueous solutions by nanofiltration, *Desalination*, **2014**, 343, 67-74;
20. Fang, J., Deng, B.: Arsenic Rejection by Nanofiltration Membranes: Effect of Operating Parameters and Model Analysis, *Environmental Engineering Science*, **2014**, 31, 496-506;
21. Al-Rashdi, B.A.M., Johnson, D.J., Hilal, N.: Removal of heavy metal ions by nanofiltration, *Desalination*, **2013**, 315, 2-17;
22. Benko, K., Pellegrino, J., Mason, L.W., Price, K.: Measurement of water permeation kinetics across reverse osmosis and nanofiltration membranes: apparatus development, *Journal of Membrane Science*, **2006**, 270 (1-2), 187-195;
23. Garba, Y., Taha, S., Gondrexon N., Dorange, G.: Ion transport modeling through nanofiltration membranes, *Journal of Membrane Science*, **1999**, 160, 187-200;
24. Belkhouche, N., Didi, M.A., Taha, S., Benfarès, N.: Zinc rejection from leachate solutions of industrial solid waste-effects of pressure and concentration on nanofiltration membrane performance, *Desalination*, **2009**, 239, 58-65;
25. Muthukrishnan, M., Guha, B.K.: Effect of pH on rejection of hexavalent chromium by nanofiltration, *Desalination*, **2008**, 219, 171-178;
26. Chang, F., Liu, W., Wang, X.: Comparison of polyamide nanofiltration and low-pressure reverse osmosis membranes on As (III) rejection under various operational conditions, *Desalination*, **2014**, 334, 10-16.

