



Laboratoire Catalyse et Spectrochimie

Spectroscopie IR operando:

Dynamique, thermodynamique et cinétique
d'adsorbats : application aux alcanes dans les
zéolithes.

Arnaud TRAVERT

Normandie Univ, ENSICAEN, UNICAEN, CNRS, Caen, FRANCE

GFSV, 13-15 Mai 2019





Catalysis and Operando Spectroscopy

- Heterogeneous catalysis: transformation of reactants to products (gas, liquid) by a solid surface
- The catalyst is often a black box:
 - Detail of surface reactions ?
 - Relationship with performance ?
- IR operando spectroscopy
 - Identification, quantification and physico-chemical properties of adsorbed species at reaction conditions
 - Direct relationship with catalytic activity

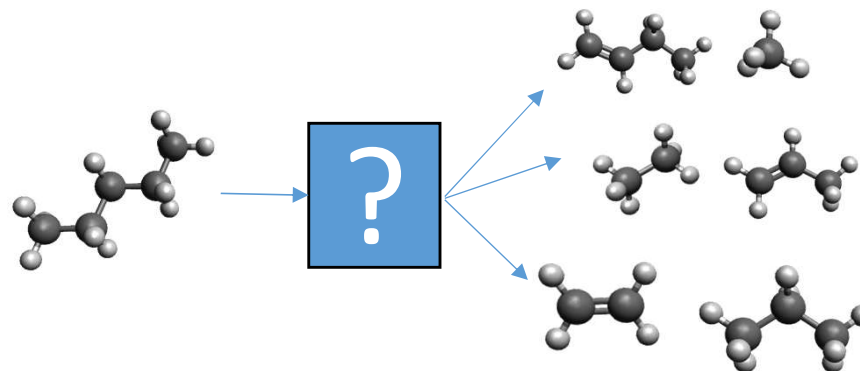

Evolution vs. T,P,t...
Kinetics / Thermo
Mechanisms / ...

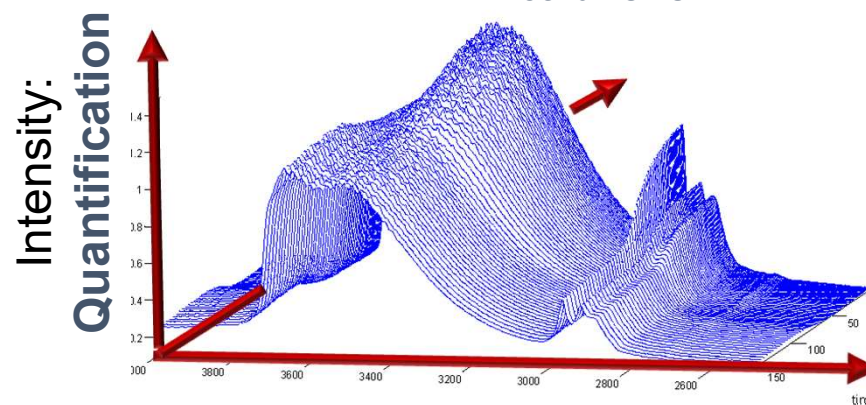

Frequency: Identification



Zeolites and catalytic cracking

H-FAU (Y) zeolite

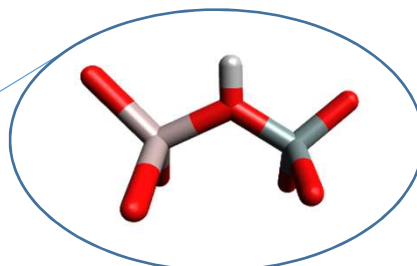
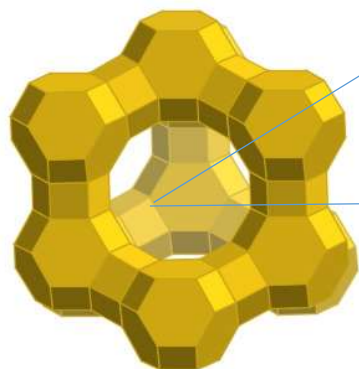

Bridged OH groups

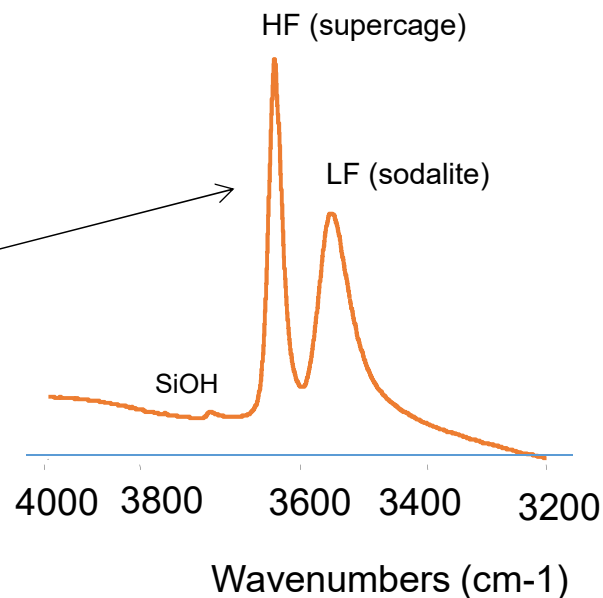

First 'operando' IR study

JOURNAL OF CATALYSIS 11, 259-273 (1968)

The Nature of Active Sites on Zeolites

V. *In Situ* Spectroscopic Observations of Hydrogen Y Zeolite During Cumene Cracking

JOHN W. WARD

*From the Union Oil Company of California
Union Research Center*

"As the temperature is raised, the extent of interaction of cumene with the hydroxyl groups increases just as the catalytic activity increases."

"By studying a catalytic reaction by in situ infrared spectroscopy, new evidence concerning the centers of adsorption and catalytically active sites can be obtained."

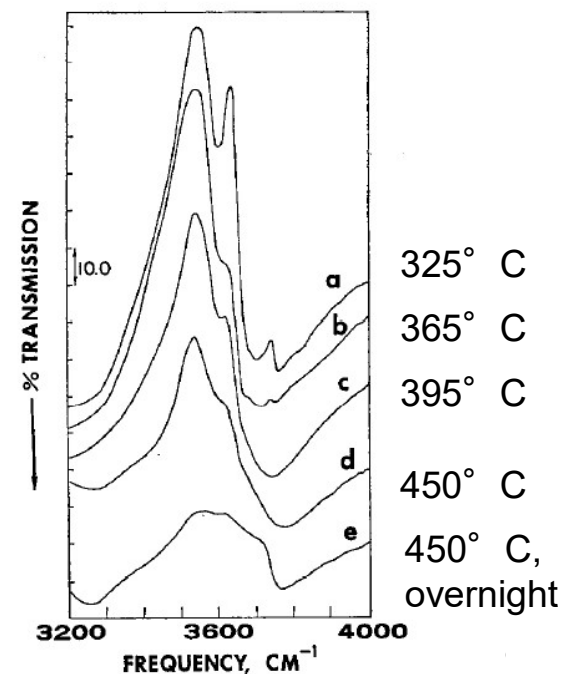



Objectives

Determine the coverage of OH groups at relevant conditions

Answer to the following questions:

How fast the reactants **diffuse** to the active sites?

What governs alkane relative reactivity: **Adsorption** or **Intrinsic kinetic** parameters ?

What is the dominant factor: **energy** or **entropy** ?



Consider a much simpler reaction: monomolecular cracking

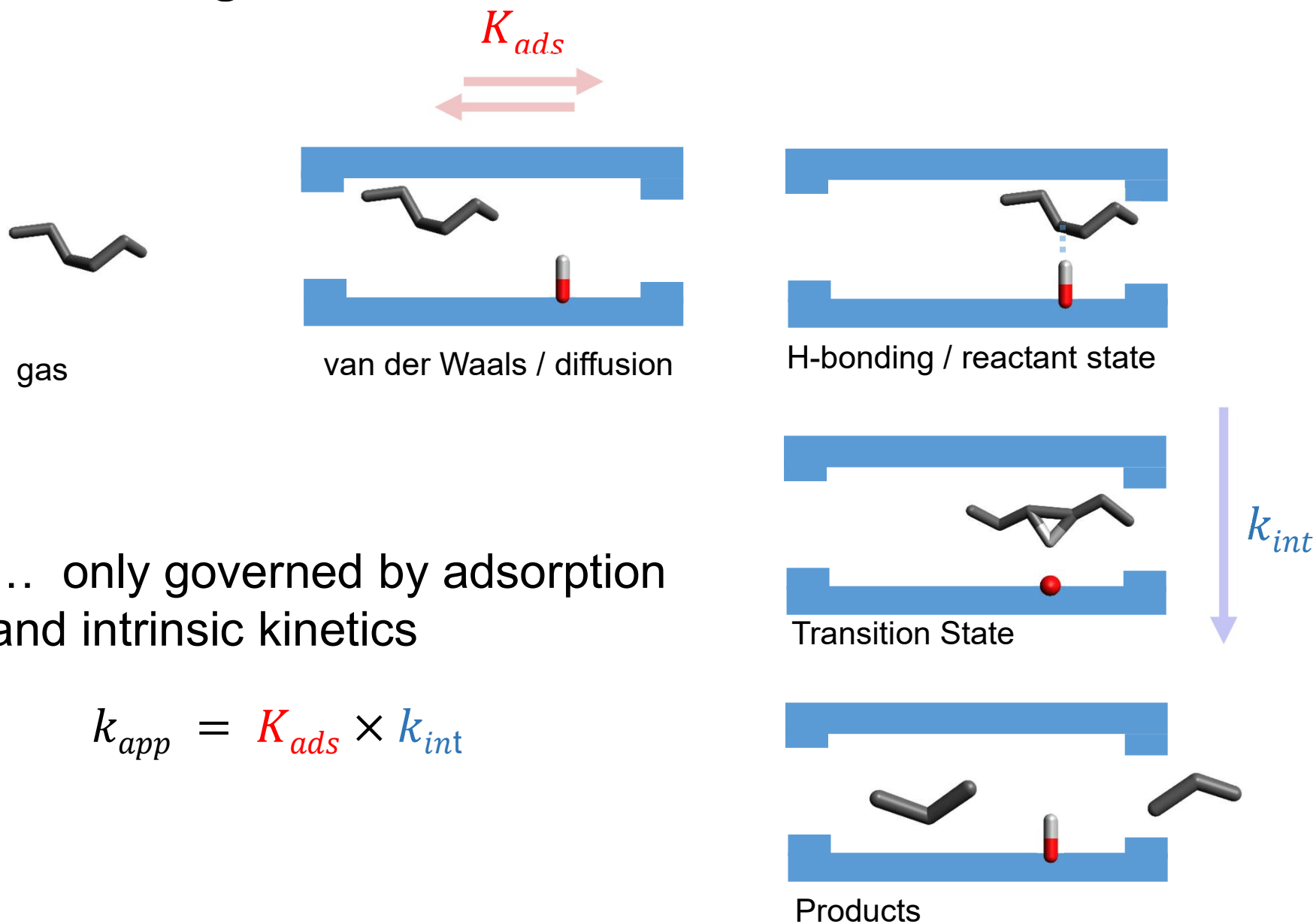

... only governed by adsorption and intrinsic kinetics

$$k_{app} = K_{ads} \times k_{int}$$



Enthalpic and Entropic Contributions to k_{app}

Apparent rate parameters

$$k_{app} = A_{app} e^{-E_{app}/RT}$$

Apparent activation energy

$$E_{app} = \Delta_{ads}H + E_a$$

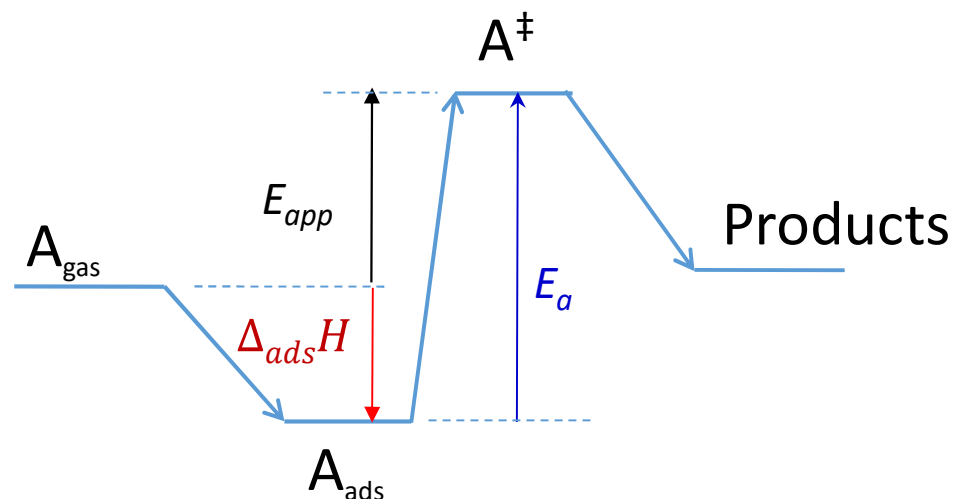

Apparent pre-exponential factor / apparent activation entropy

$$A_{app} = \frac{k_B T e}{h} \exp\left(\frac{\Delta_{ads}S + \Delta S^\ddagger}{R}\right)$$

Four parameters determine the TOF & structure activity relationships ...



Structure-activity relationships & Energetic aspects

1. Larger alkanes crack faster ($r_{C_6} \gg r_{C_3}$)
2. Small pore zeolites are more active (e.g. FER > FAU)

$$k_{app} = K_{ads} \times k_{int}$$

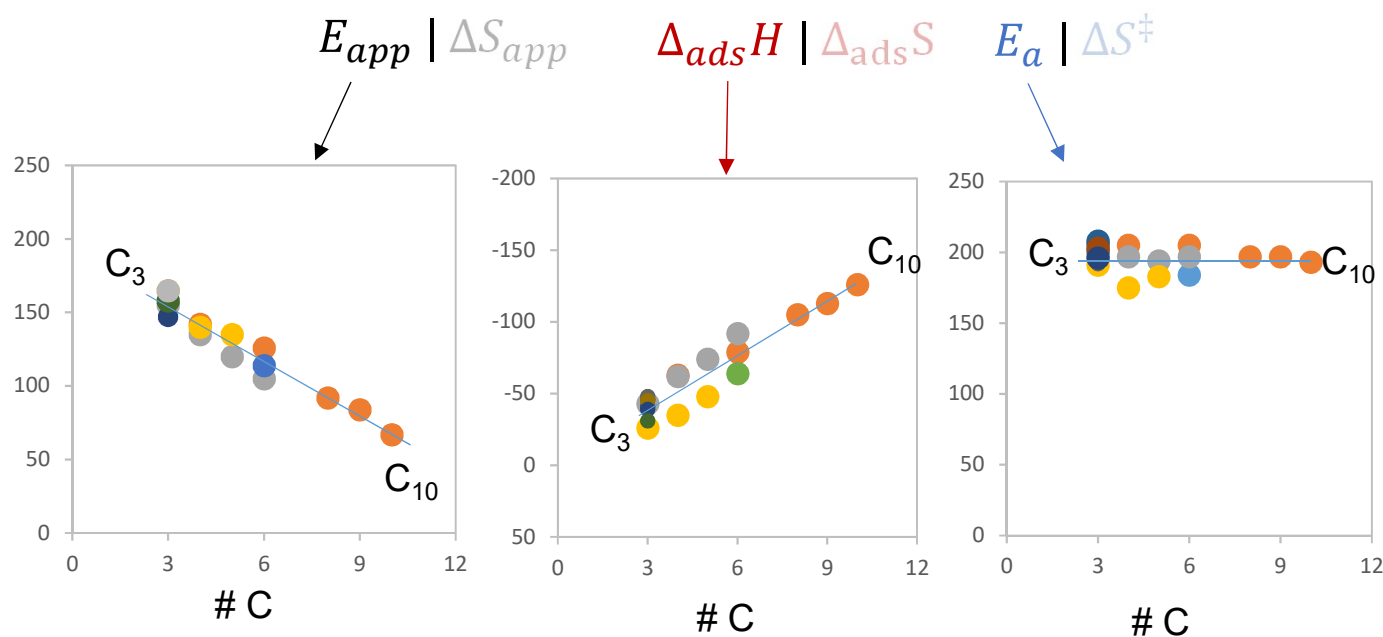

Haag, *Stud. Surf. Sci. Catal.* **1994**
Narbeshuber et al. *J. Catal.* **1995**
Eder et al. *J. Phys. Chem. B* **1997**
Babitz et al. *Appl. Catal. A* **1999**
van Bokhoven et al. *J. Catal.* **2004**
Kotrel et al. *J. Phys. Chem. B* **1999**
Xu et al. *J. Catal.* **2006**
Gounder and Iglesia, *JACS*, **2009**
Ibid., *Acc. Chem. Res.*, **2012**
Liu et al. *ACS Catal.* **2011**

Zeolite types:
MFI, FER, BEA, FAU, MWW,
...

Dominant role of Coverage ?



Enthalpy-Entropy Compensation: $K_{ads} = f(\Delta_{ads}H, \Delta_{ads}S)$

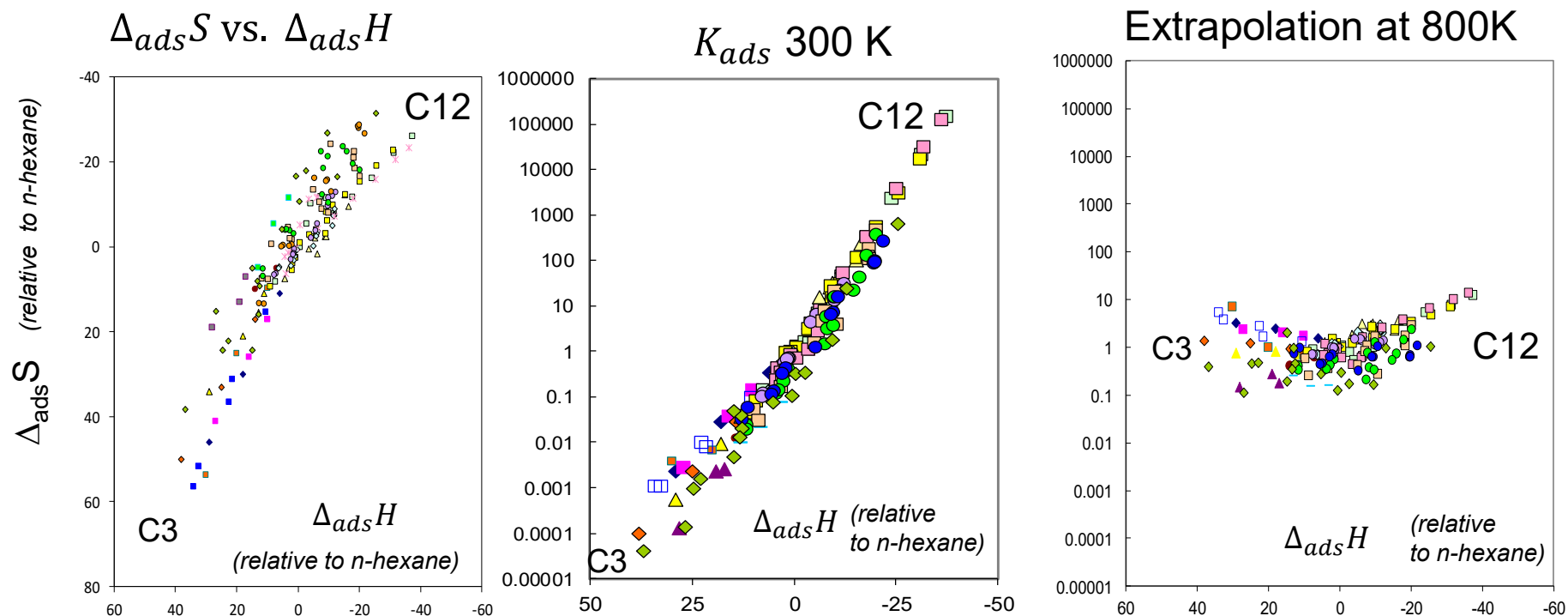

Eder et al. *J Phys Chem B* **1997** ;
 Denayer et al. *J. Phys. Chem B.* **1998**;
 Van Bokhoven et al. *J Catal.* **2004**
 Ramachadran et al. *J. Catal* **2005** ;
 Baron et al. *J. Phys Chem B* **2008**

- Extrapolated coverage are not correlated to cracking rates
- Alternative explanation: E_a , $\Delta_{ads}H$, $\Delta_{ads}S$, ΔS^\ddagger

A. Bhan, R. Gounder, J. Macht, E. Iglesia,
J. Catal. **2008**

Activation Entropy governs relative activities ?



Molecular simulations

Temperature strongly affects $\Delta_{\text{ads}}S$

Bučko et al. *J. Catal.* **2011** ; Jiang et al. *ACS Catal.* **2015**
Swisher et al. *J. Phys. Chem B.* **2010** ; Tranca et al. *JPC* **2012** ;

- Larger entropy of the adsorbed state
- Impacts coverages & intrinsic rates

New explanation for structure activity relationships

Janda et al. *J. Phys. Chem B.* **2015**, *J. Am. Chem. Soc.* **2016**

- ΔS^\ddagger independent of chain length
- E_a determines relative activities

Orthogonal conclusions !

Further investigations needed...

Distribution of alkane–acid site distances (Bučko et al **2011**)

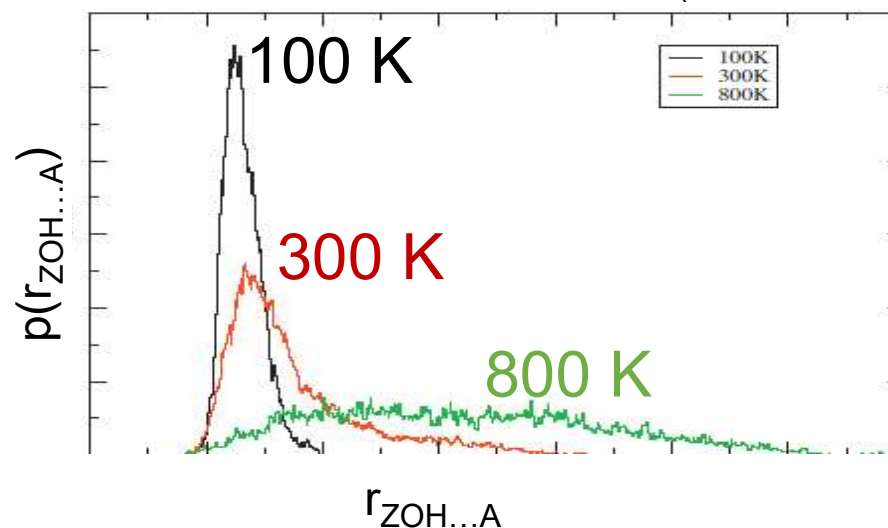

Predicted Activation parameters on MFI (Janda et al **2015**)

	E_a kJ mol ⁻¹	ΔS^\ddagger J mol ⁻¹ K ⁻¹
C3	198	-21
C4	188	-25
C5	183	-23
C6	177	-24



IR Operando spectroscopy

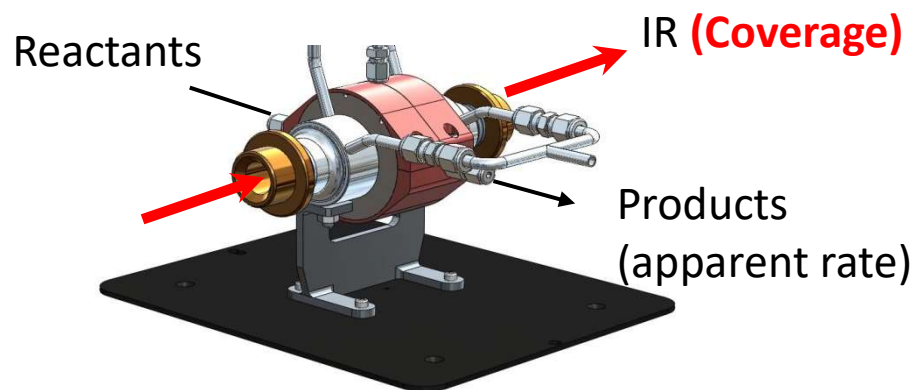

n-Alkanes: C3 - n-C7

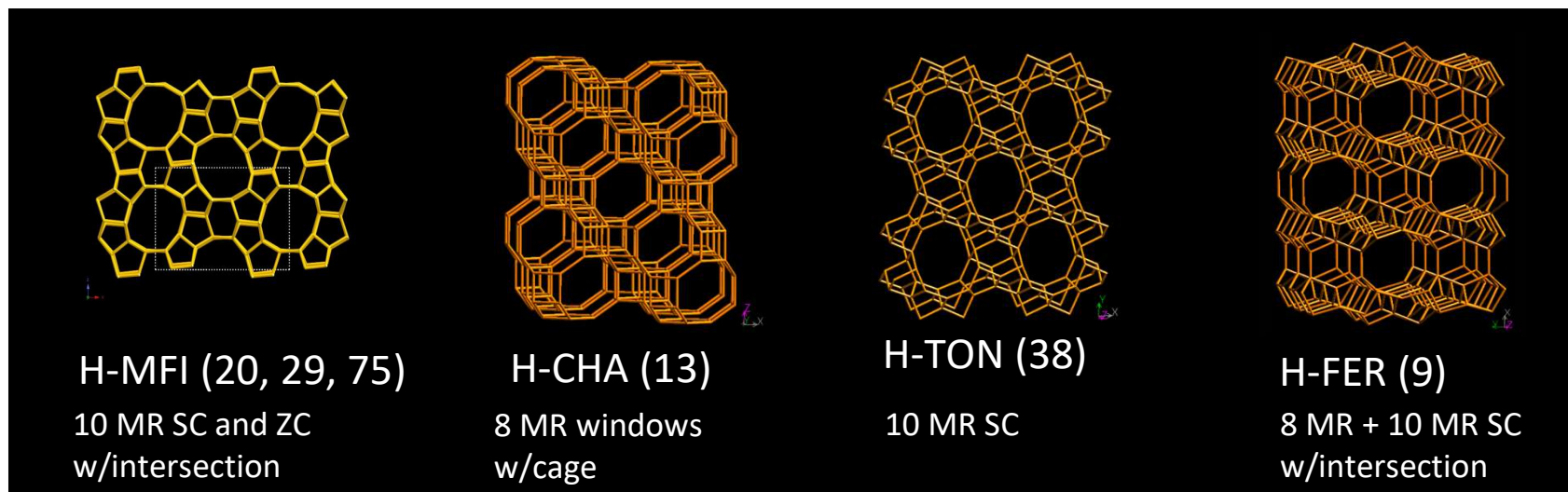
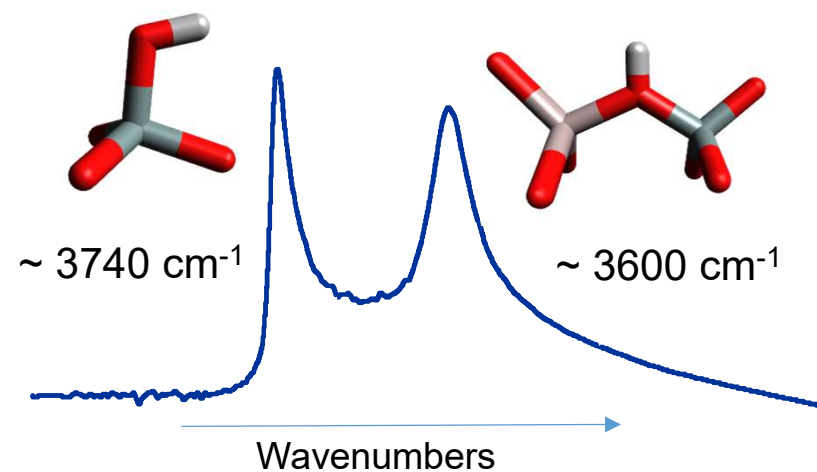



Determination of coverage

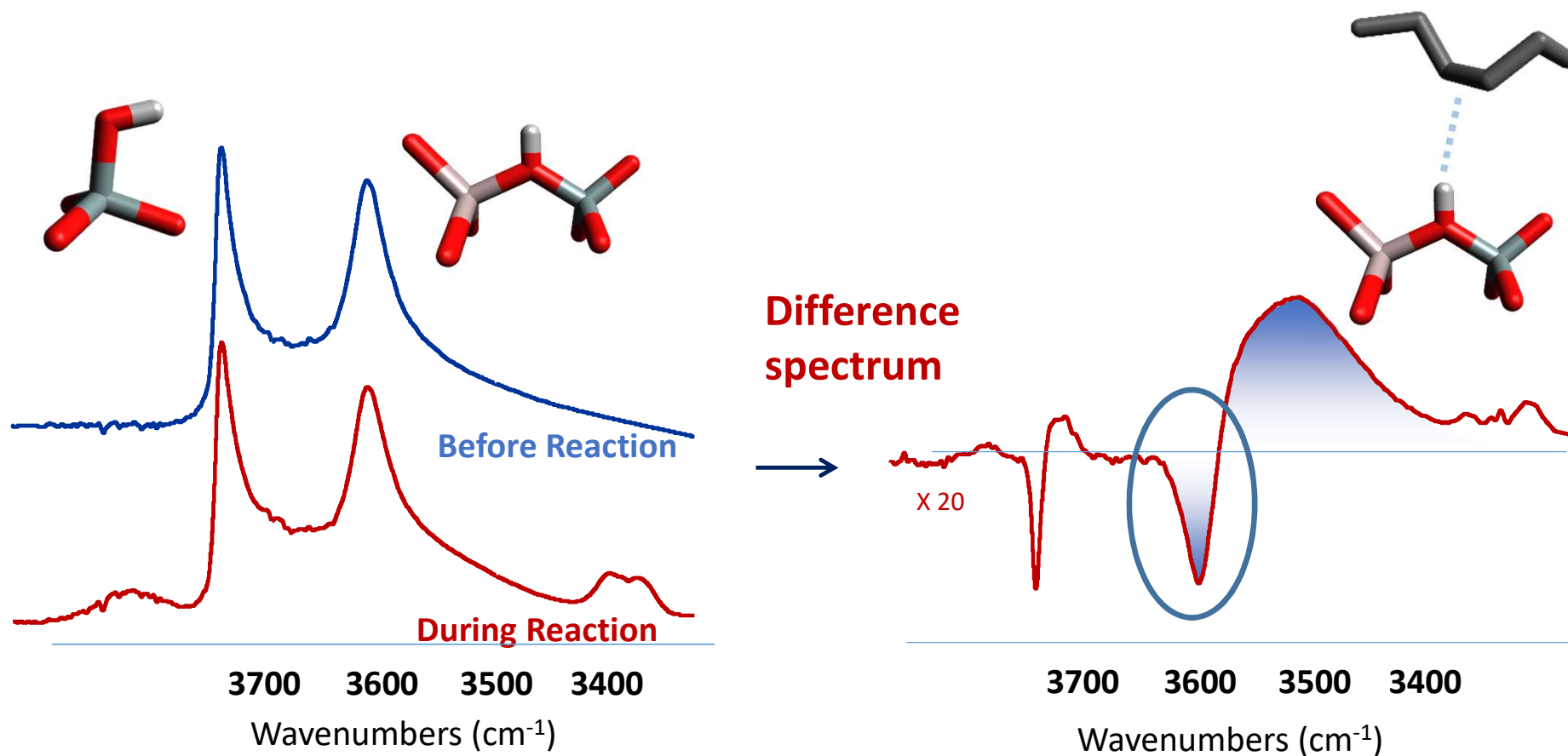

Area of negative band allows to quantify the **coverage**



Simultaneous Assessment of rate and coverage

Apparent rate [C3/H-MFI(29), 687 K]

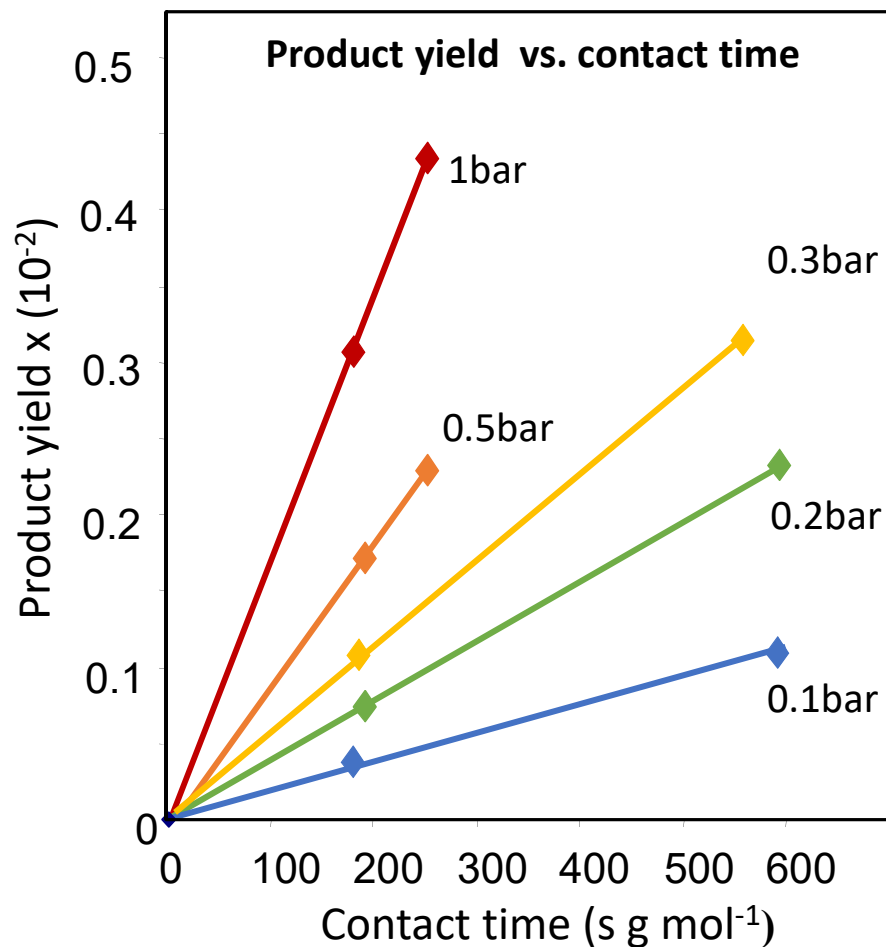

Coverage [C3/H-MFI(29), 687 K]

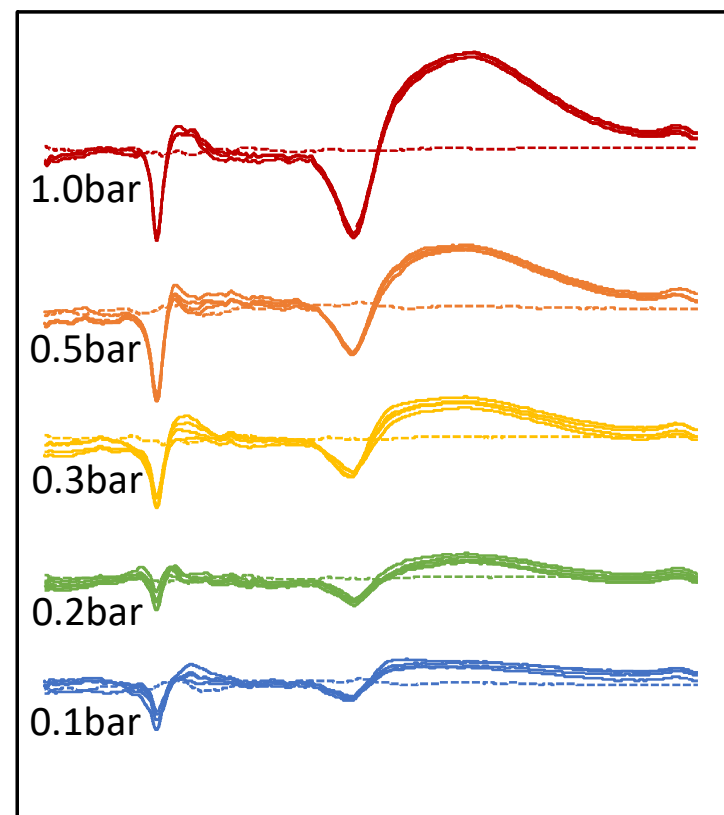

- Negligible adsorption of products
- No irreversible poisoning

Selective quantification of H-bonded alkane reactants



Determination of Adsorption Parameters at Reaction Conditions

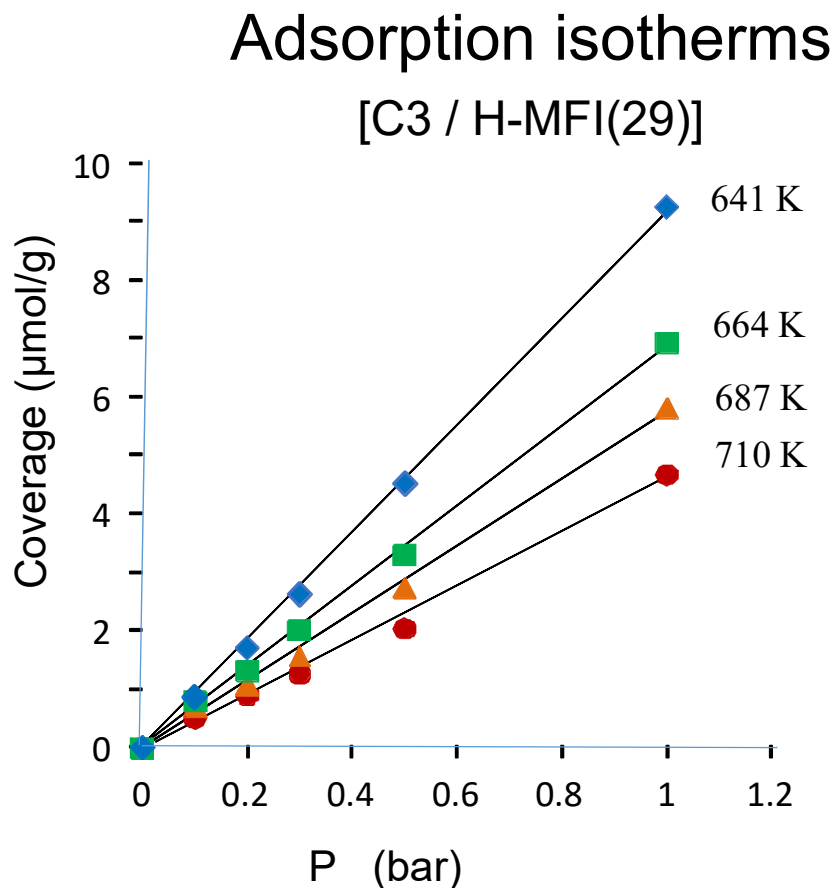

- Henry domain
- slope = $K_{ads}(T)$

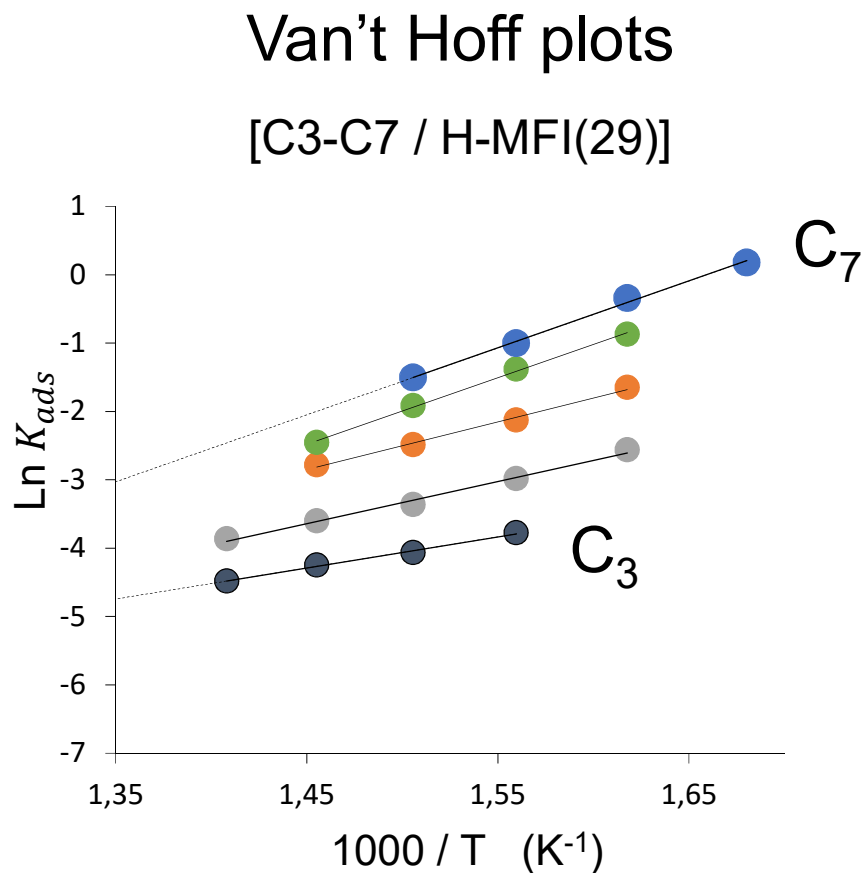

Van't Hoff plot : $\Delta_{ads}H$, $\Delta_{ads}S$



Determination of Adsorption Parameters at Reaction Conditions

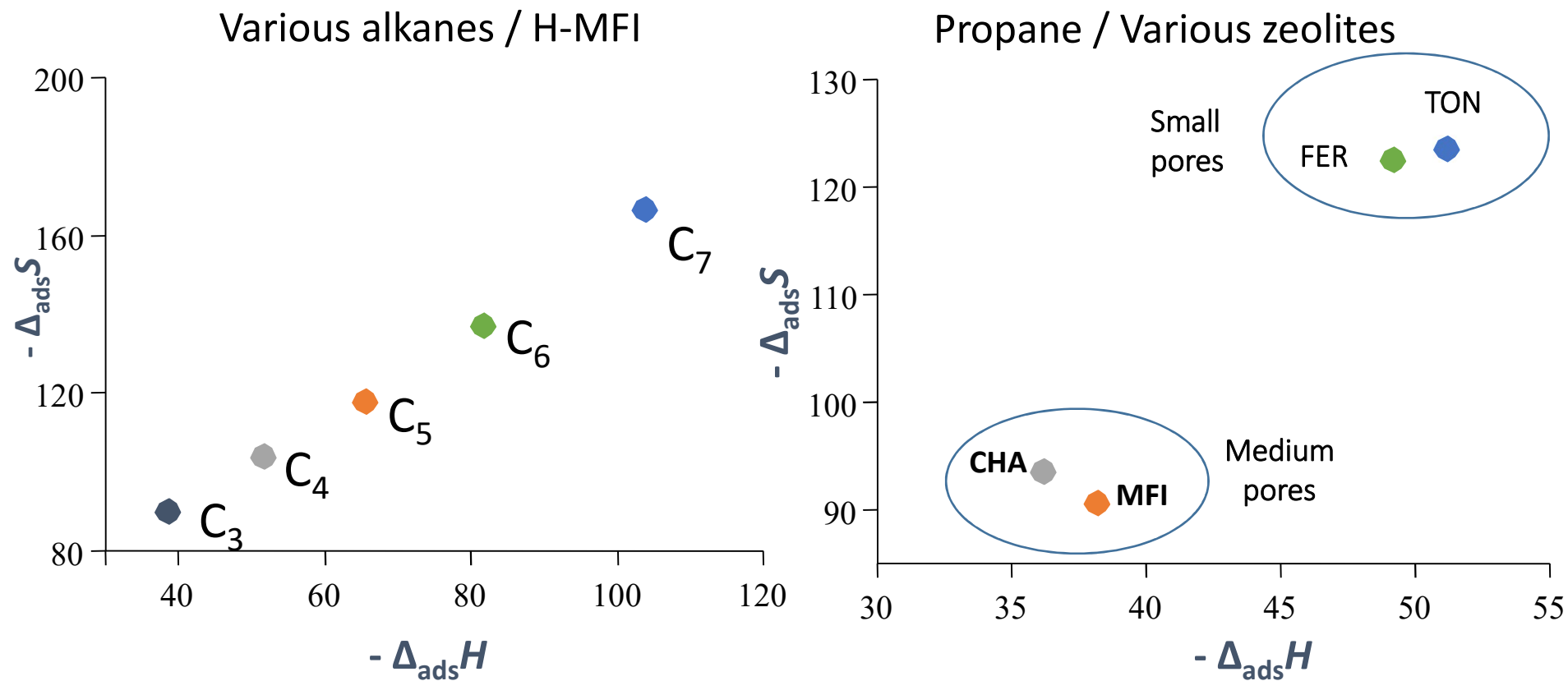

- General trends
 - Larger confinement => Larger adsorption parameters
- Qualitative agreement with previous works
- Quantitative agreement with low temperature experiments



Alkane redistribution: H-bonded vs. pure vdW states

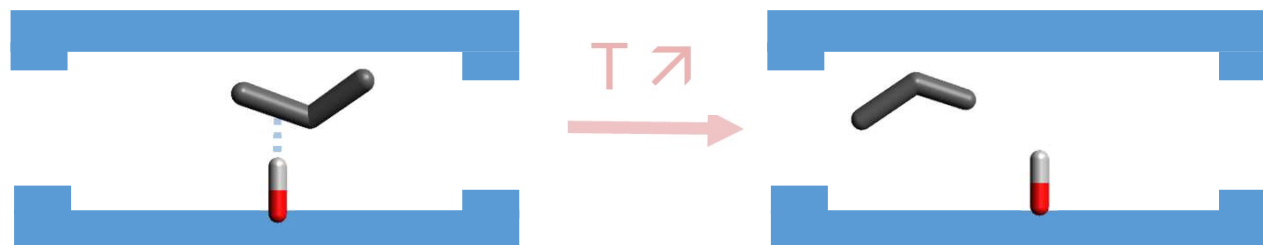
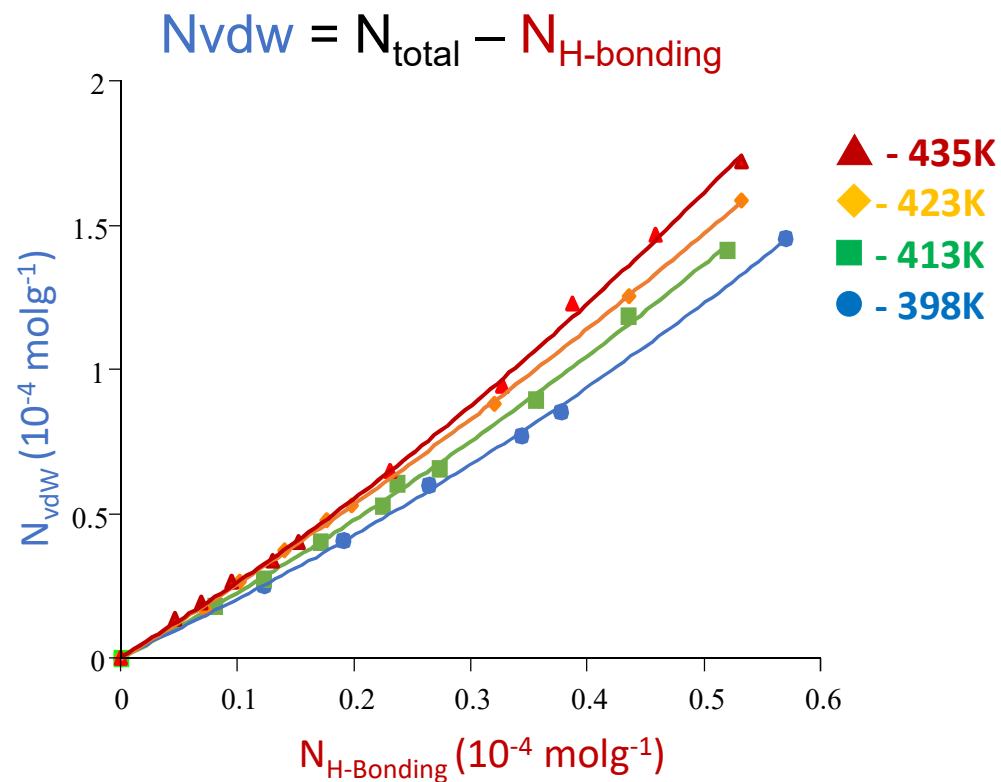
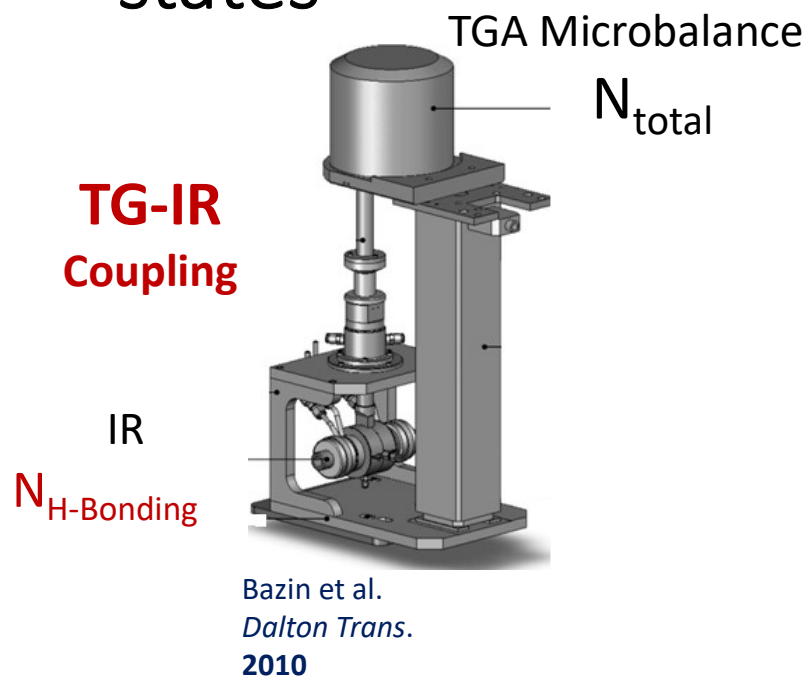

Alkane sitting is temperature dependent...



Adsorption parameters of H-bonded alkanes: Low vs. High T

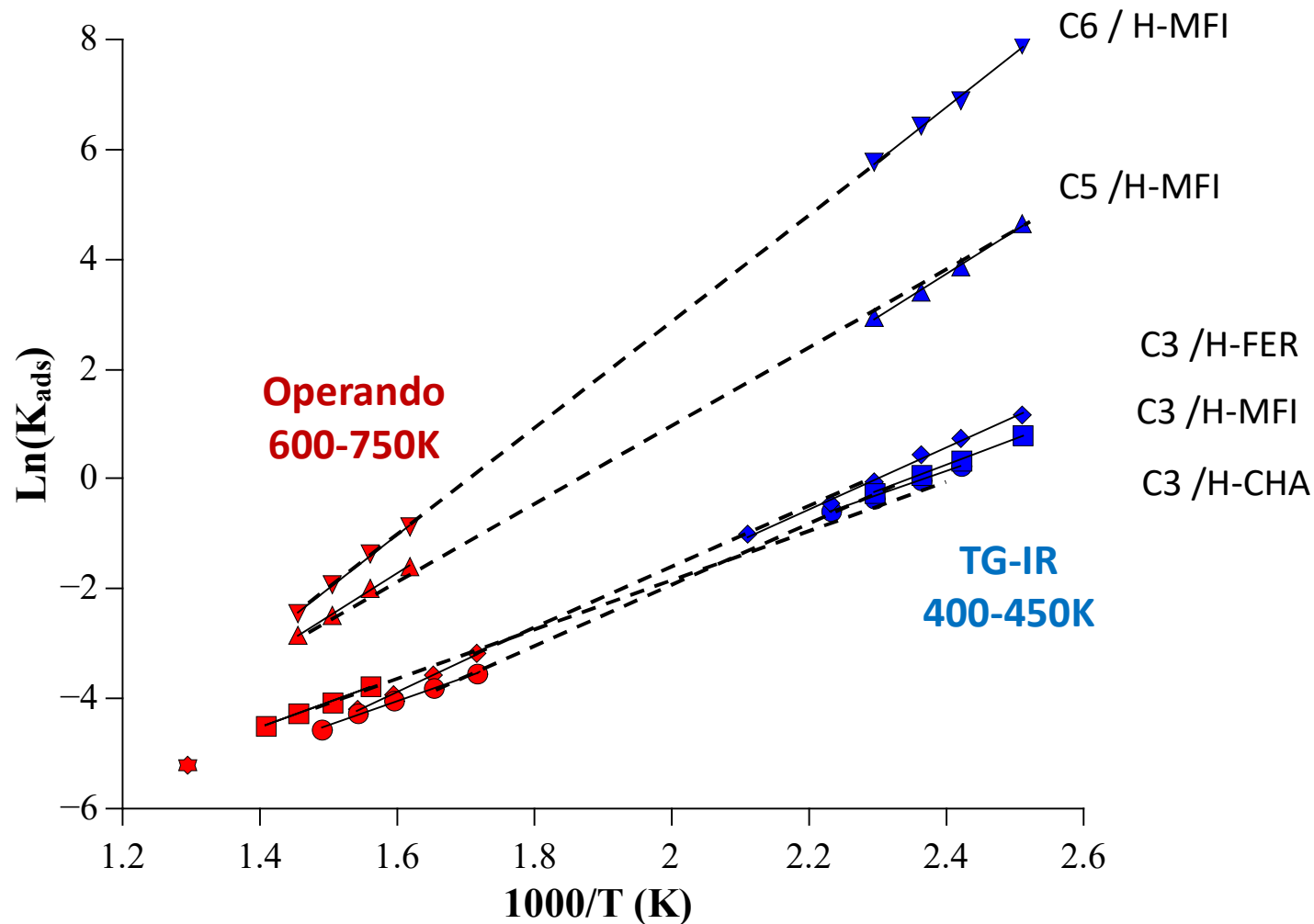

But adsorption parameters for H-bonding are T independent !!!



Validation of rate measurements in the operando cell

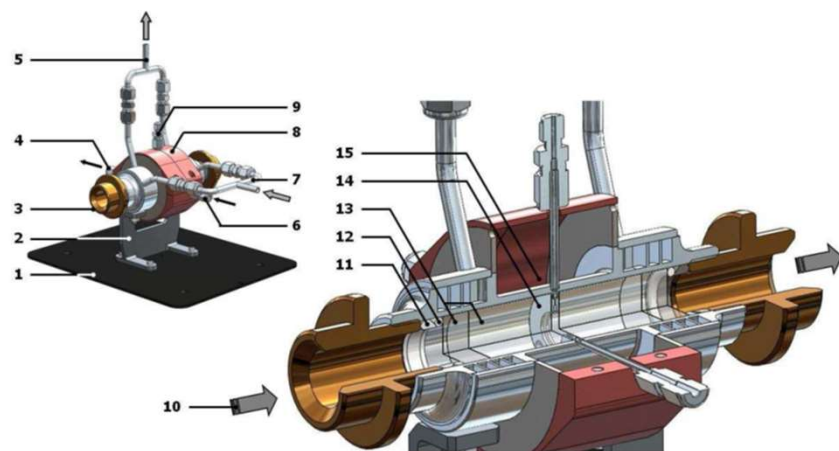

1. Test for external diffusion (Madon-Boudart)

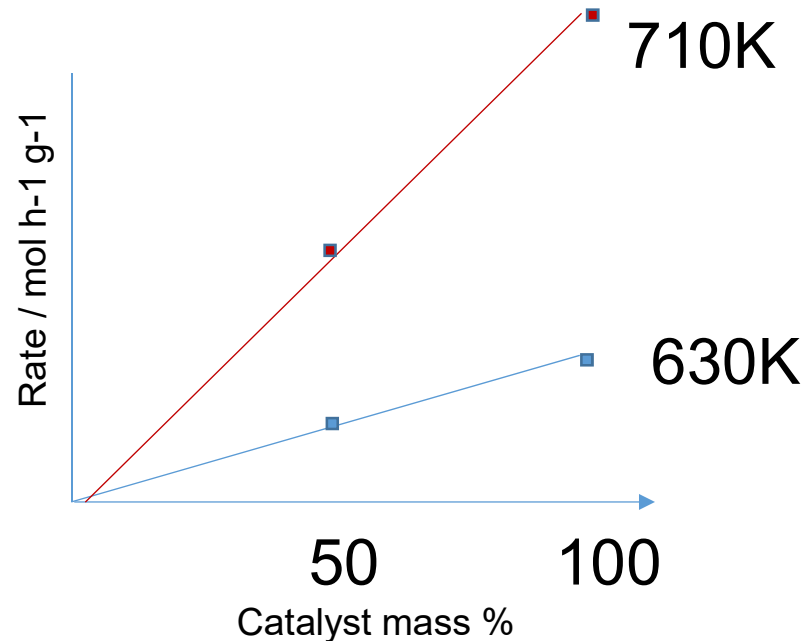

Light alkane cracking

2. Comparison with classical PF reactor & literature

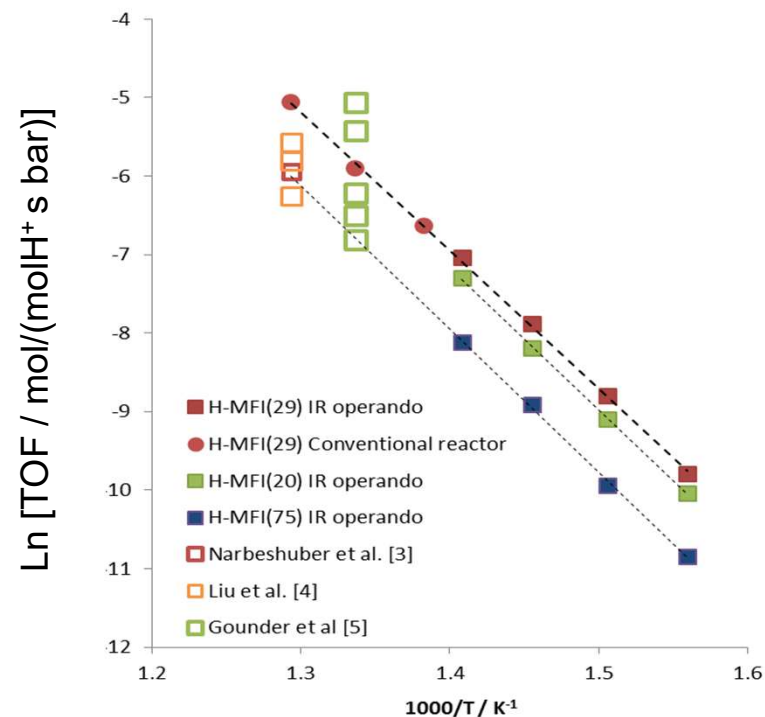

Apparent reaction parameters consistent with previous reports



Apparent rate vs. Coverage

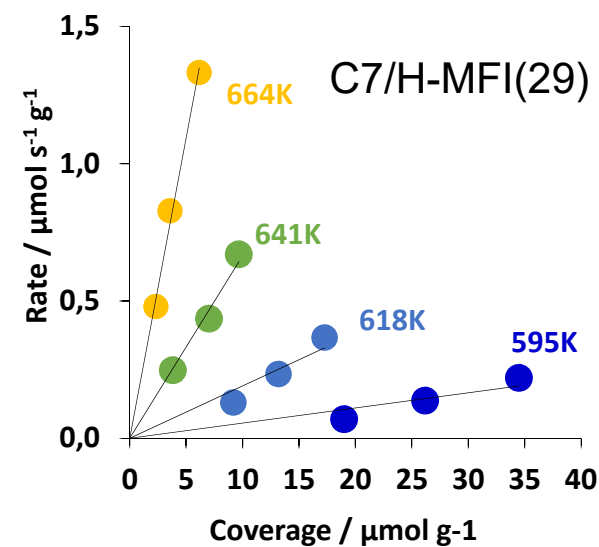
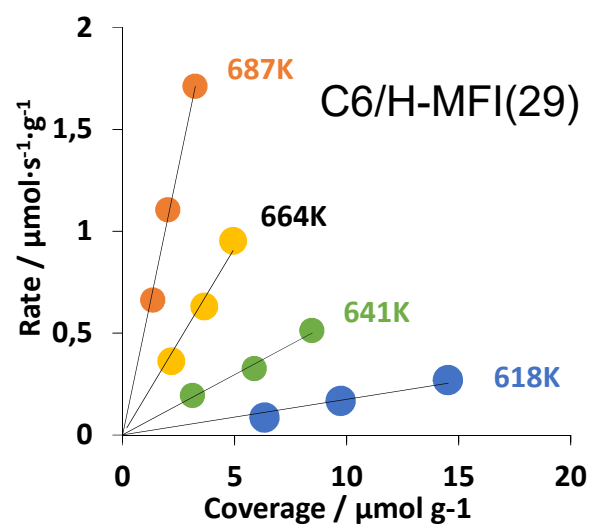
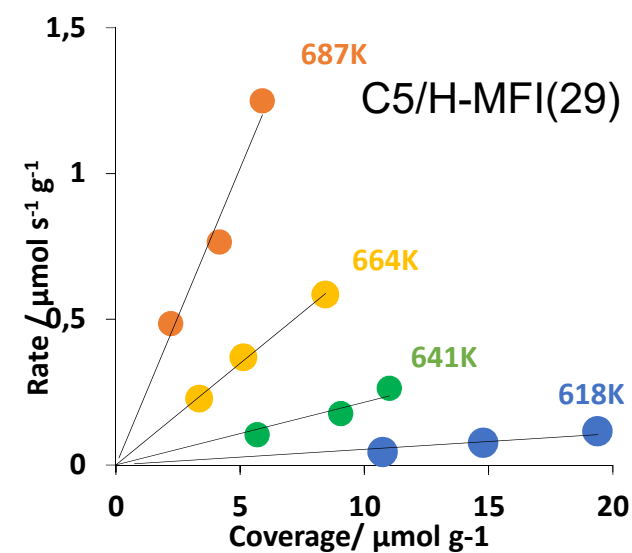
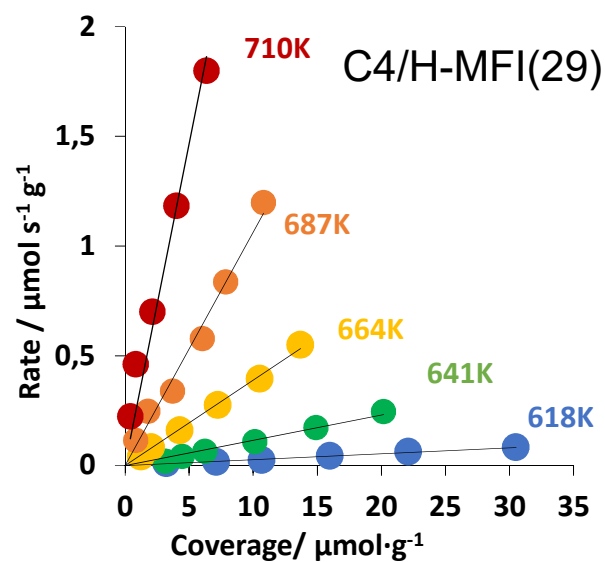
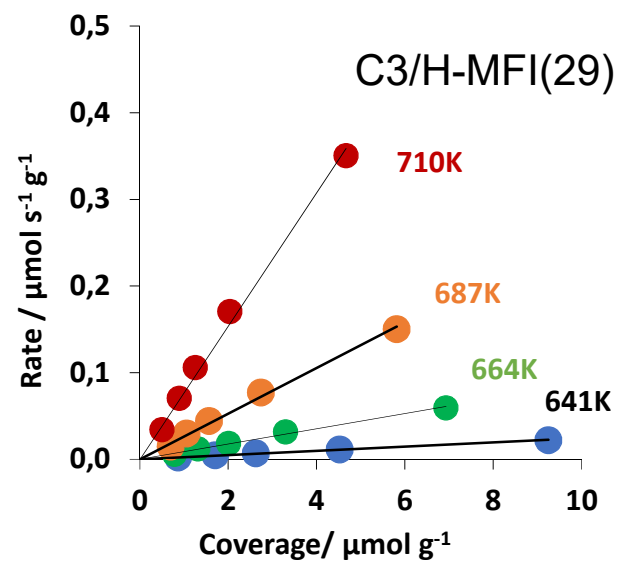

Very good correlation

Slope = intrinsic rate



Influence of chain length and pore size on intrinsic cracking rate

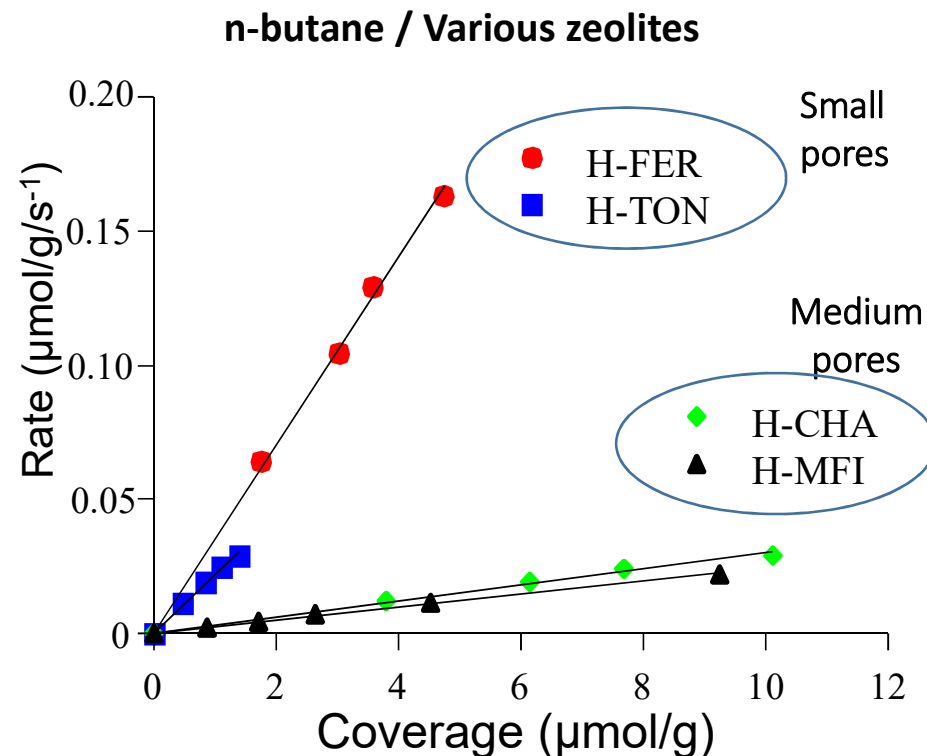
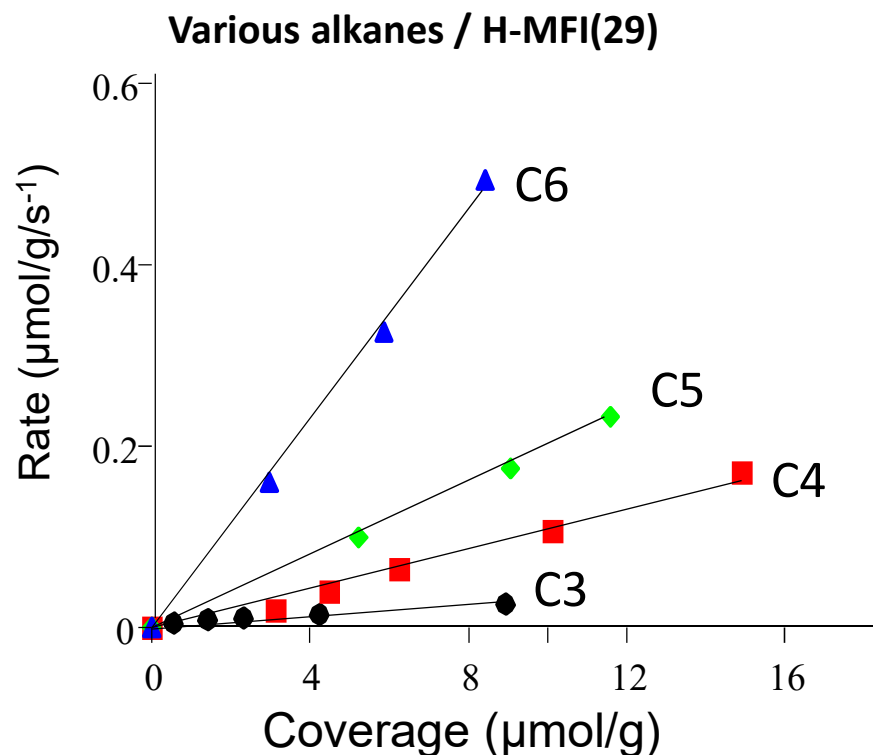

- At similar **coverage**, differences in **rates**
- Larger alkanes / smaller pores = larger intrinsic rate



Determination of Intrinsic rate parameters

Arrhenius plots of intrinsic rate constants

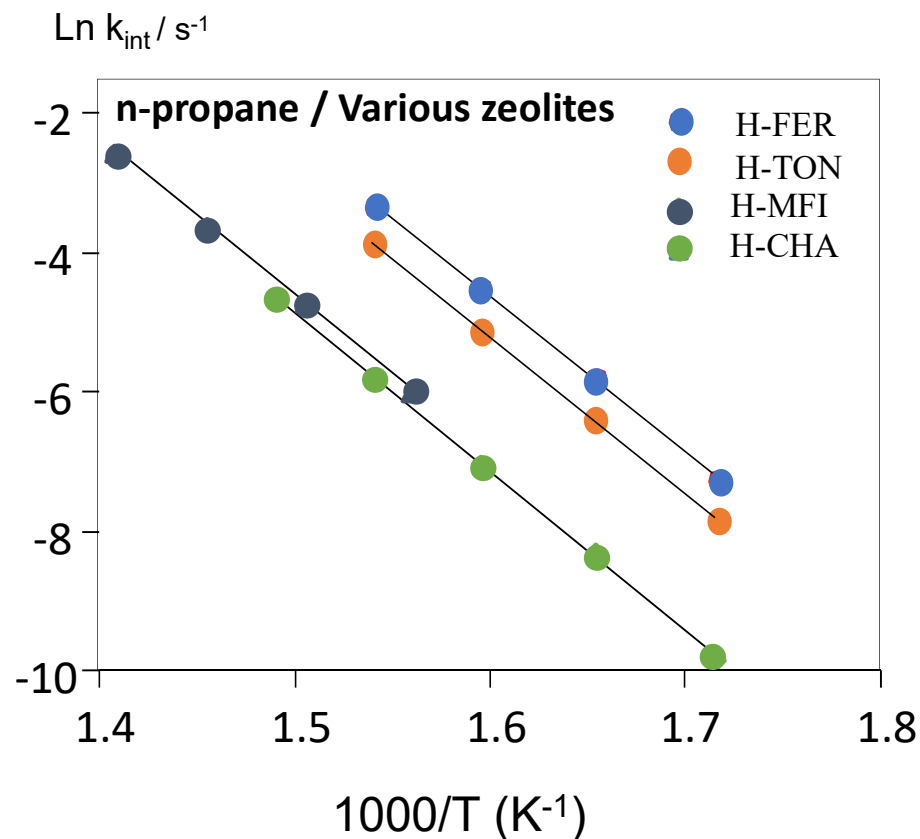
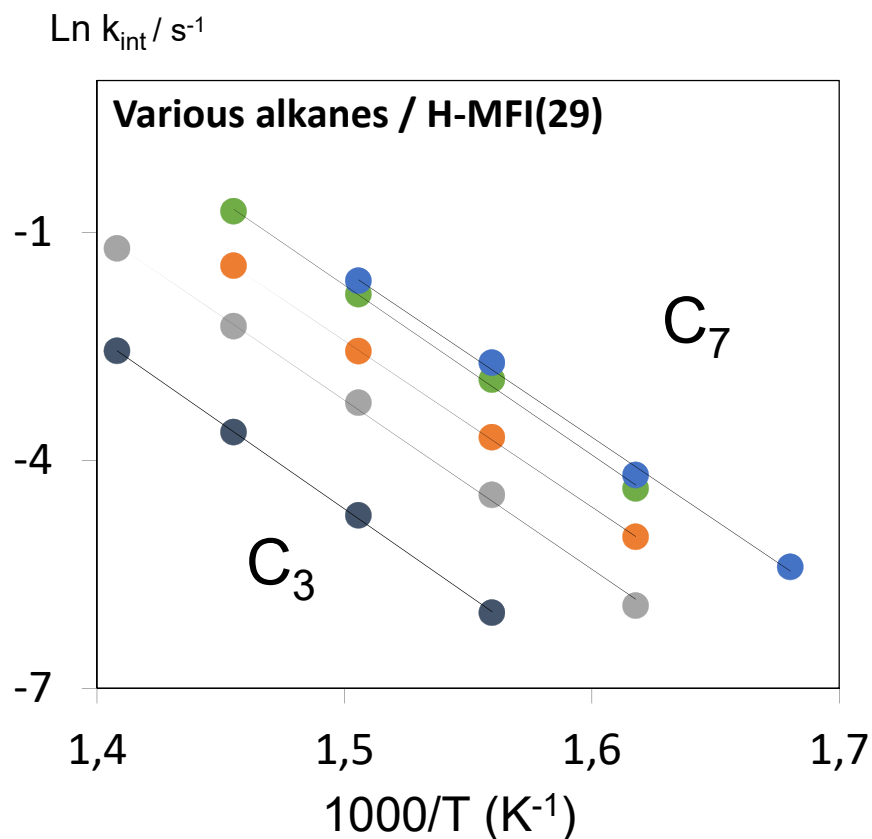

Constant slope => constant activation energy (~190 kJ/mol)
Increasing intercept => increasing activation entropy



Overall picture: influence of chain length

Alkane cracking rates over H-MFI (773 K)

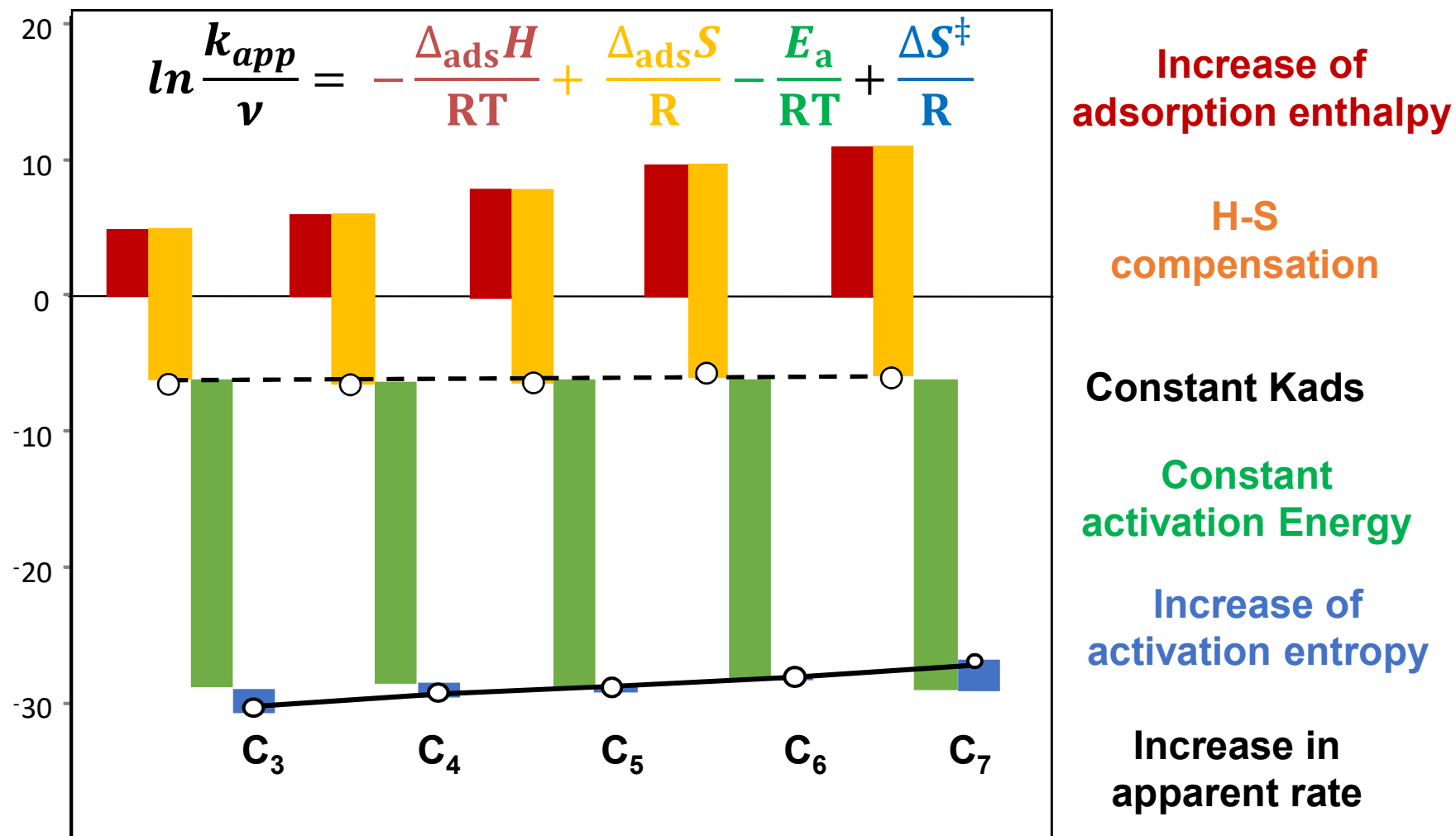



Overall picture: influence of pore size

Propane cracking rate (773 K)

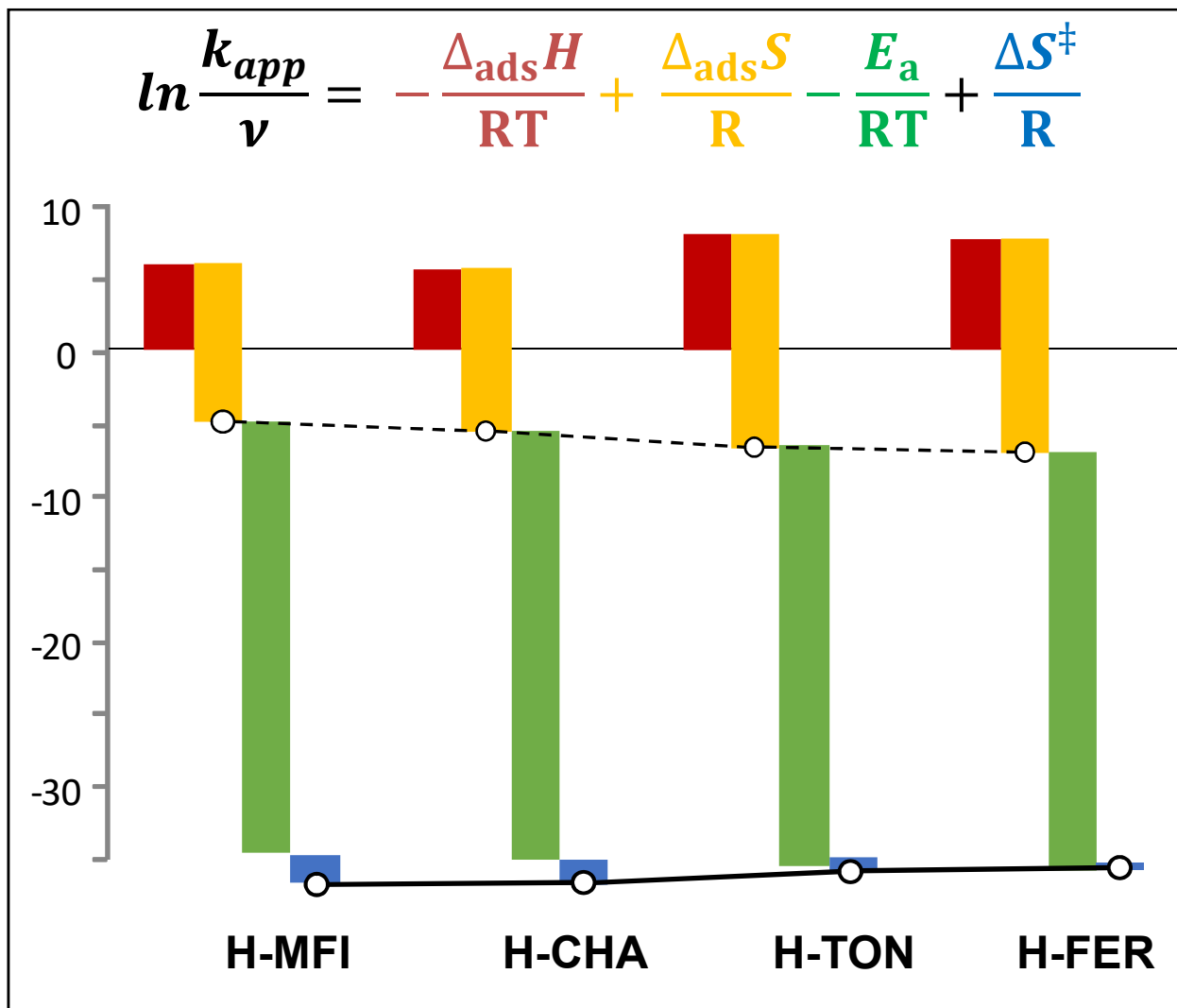

Increase of adsorption enthalpy

In complete H-S compensation

Constant Intrinsic Activation Energy

Increase in activation entropy

Increase in apparent rate



Activation entropy and confinement

Confinement index: $\frac{\text{molecular volume}}{\text{effective pore volume}} \approx \frac{\text{molecular volume}}{\frac{4}{3}\pi r_{eff}^3}$

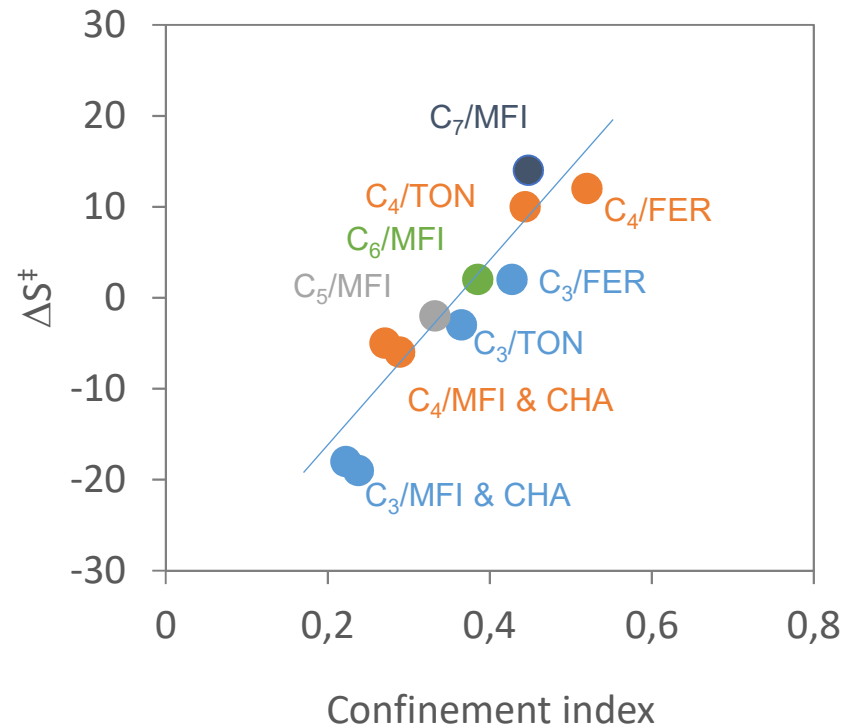

Activation entropy increased by « confinement»...
... but which degrees of freedom are affected ?



Some answers to initial questions

What governs alkane relative reactivity: **Adsorption** or **Intrinsic kinetic** parameters ?

Surface kinetics

What is the dominant factor: **energy** or **entropy** ?

Entropy

How fast the reactants **diffuse** to the active sites?

????



How fast the reactants reach the active sites ?

Non equilibrium coverage in case of internal diffusion limitations

- limits zeolite efficiency
- can be mitigated by adding mesopores (hierarchization)

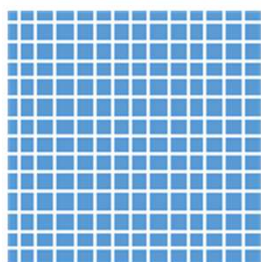

Pristine zeolite

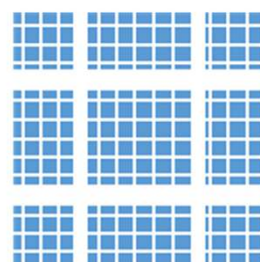

Hierarchical zeolite

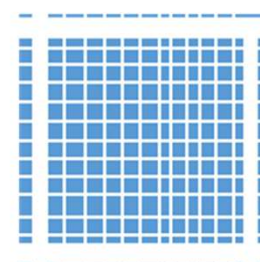

Hierarchical ?

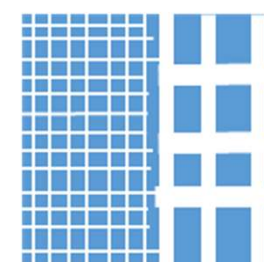

Mechanical mixture

Assessing the hierarchization of meso-microporous materials ?

- Classical diffusion measurements (gravimetry, volumetry, IR) yield effective diffusivities 'averaged' over the various porous systems

TGA

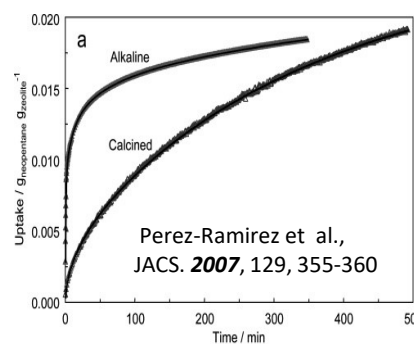

IR (DRIFT)

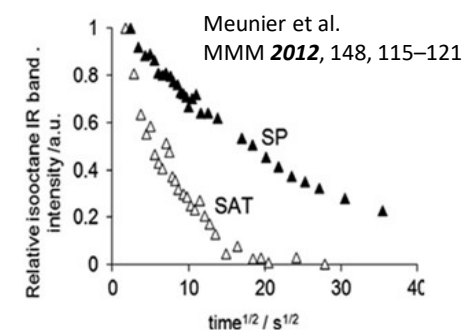

PFG NMR

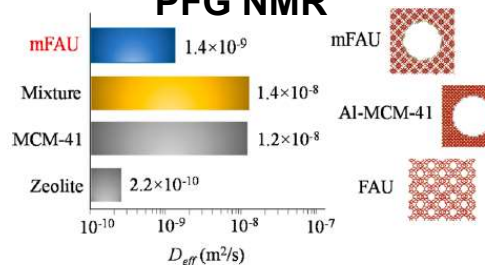

Galarneau et al., JPC **2016**, 120, 1562-1569



Proof of concept: compare pure zeolites vs. Mechanical mixture

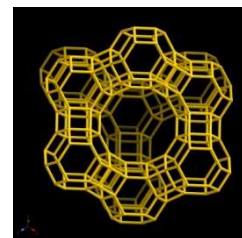

FAU

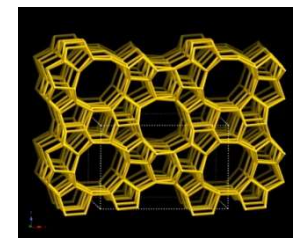

MFI

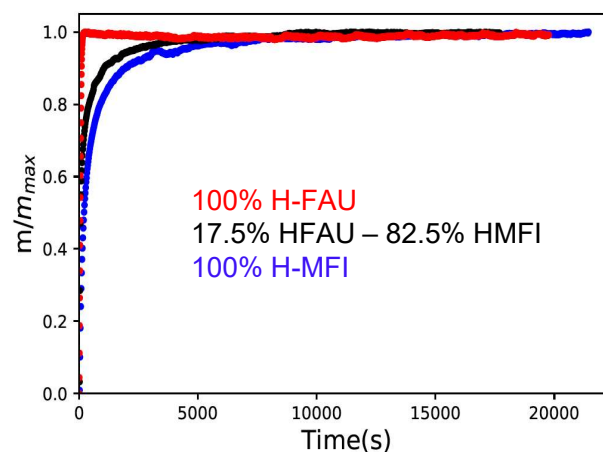
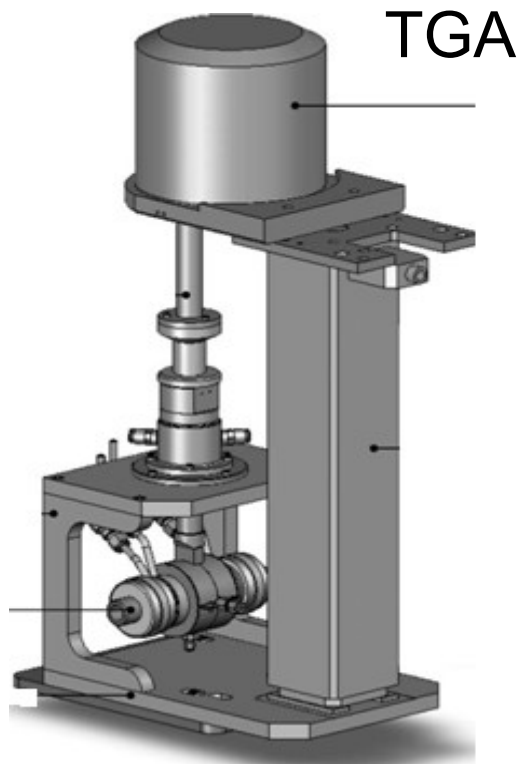

Relative uptake curves on zeolites and mechanical after normalization

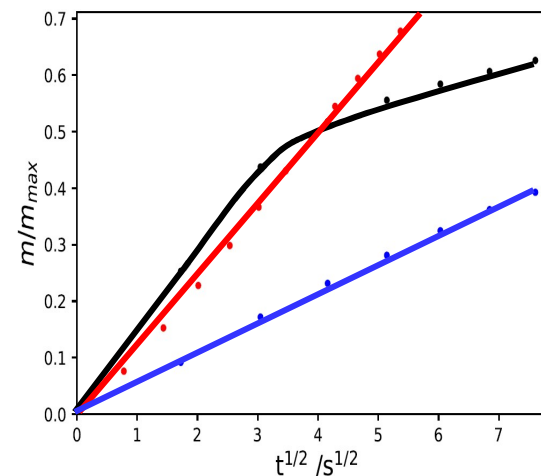

Normalized uptake curves at short times

Diffusivities determined by TGA are governed by the larger porous network with the largest pores



Proof of concept: compare pure zeolites vs. Mechanical mixture

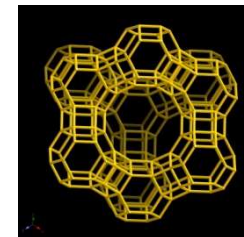

FAU

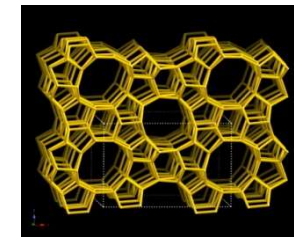

MFI

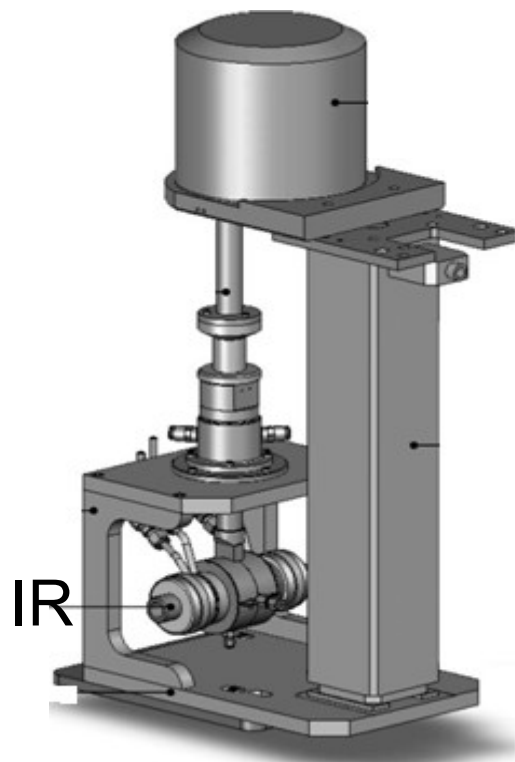

IR

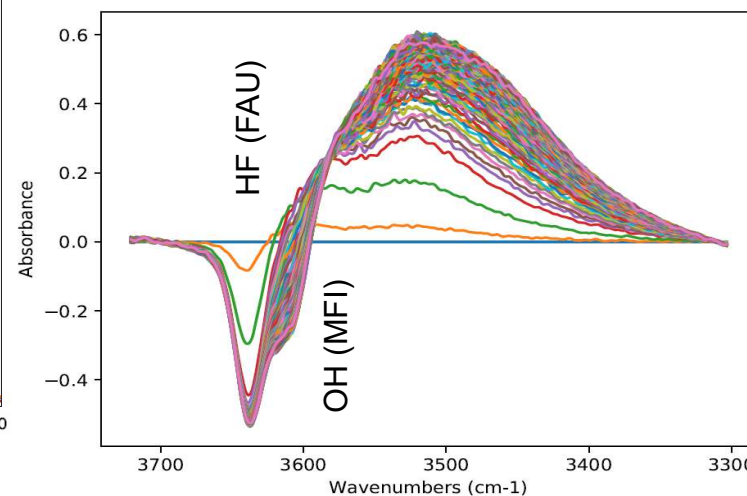
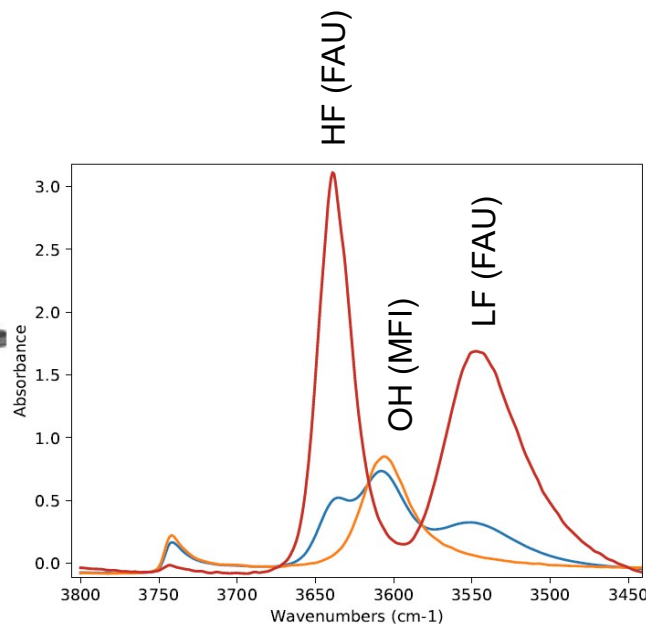

IR spectra of pure samples and mechanical mixture

- IR monitoring of specific OH groups allows to distinguish diffusivities of **both** porous systems (H-MFI and HFAU)



Proof of concept: compare pure zeolites vs. Mechanical mixture

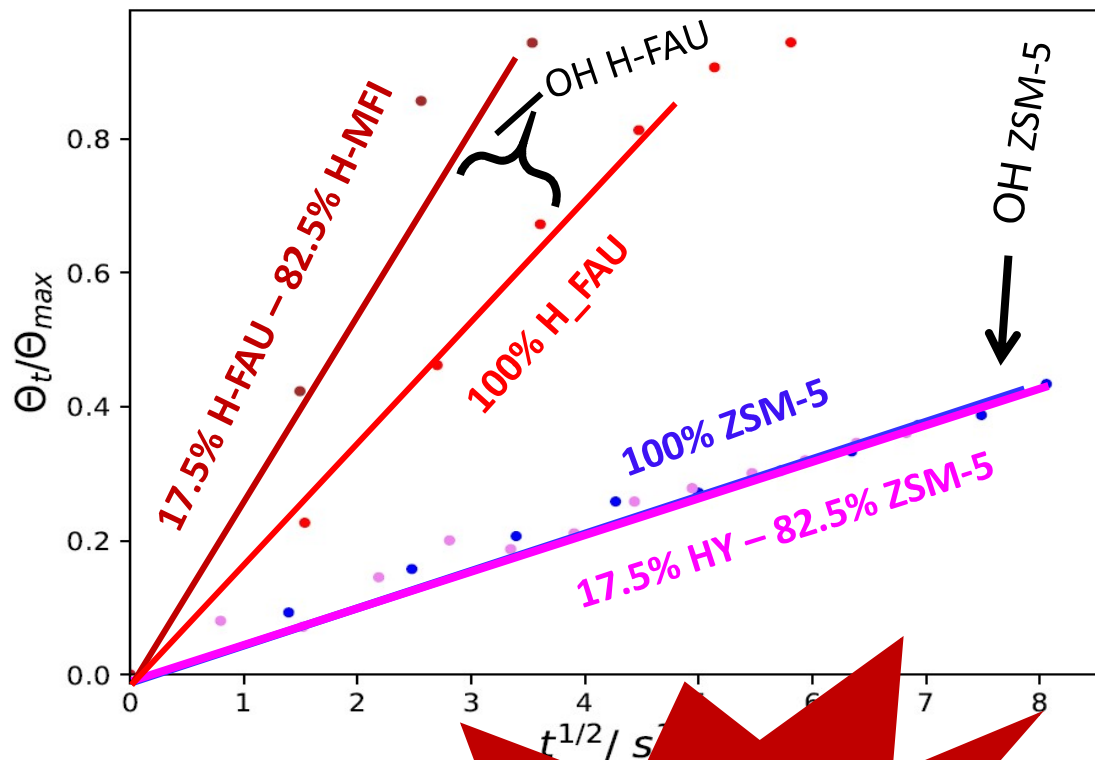
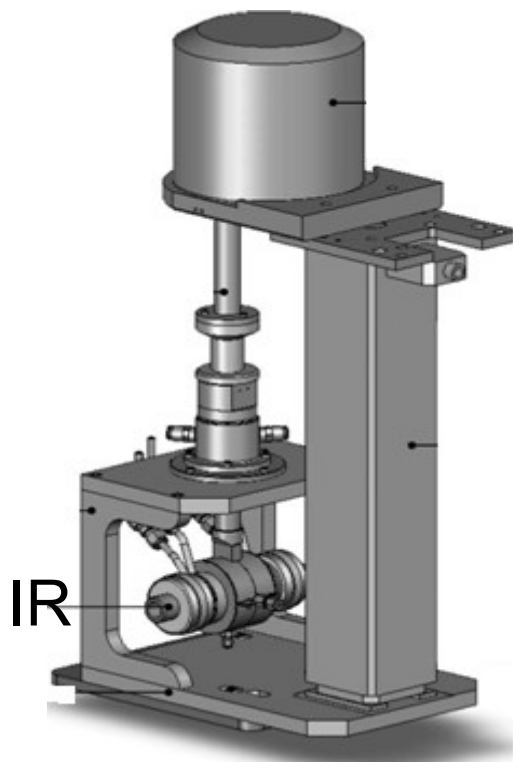
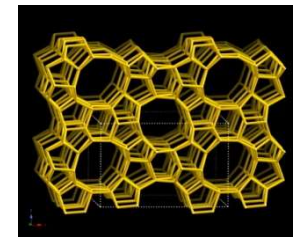
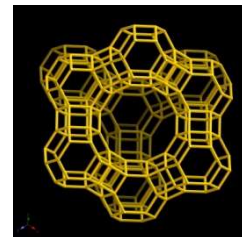

Diffusivities in each samples and pure

Time resolution limits the precision for the fastest network....

Attend the talk of Josefine Schnee !



Application to hierarchical H-MFI zeolites

Hierarchization by fluoride treatment

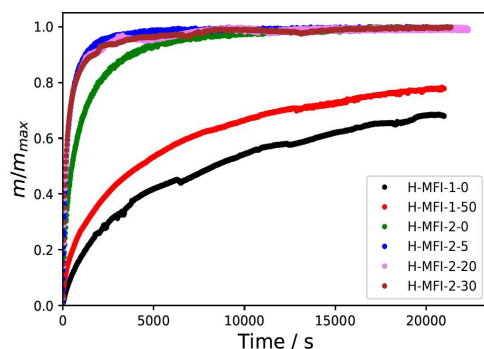
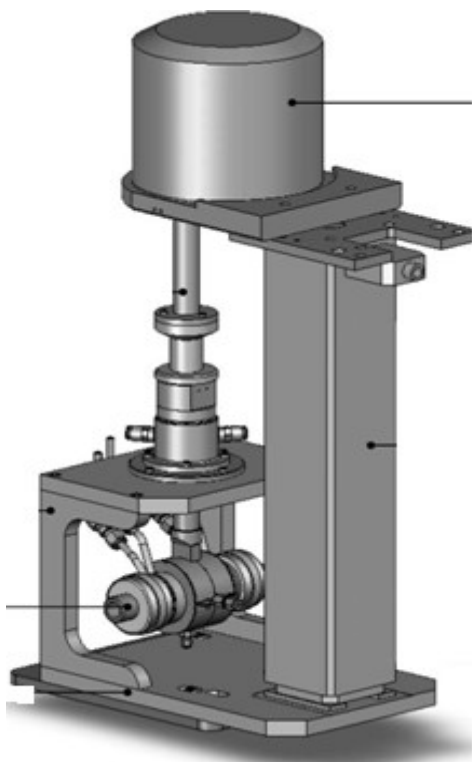

TGA (global)

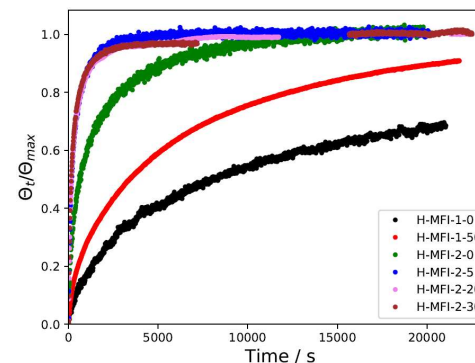

IR (adsorption on OH)

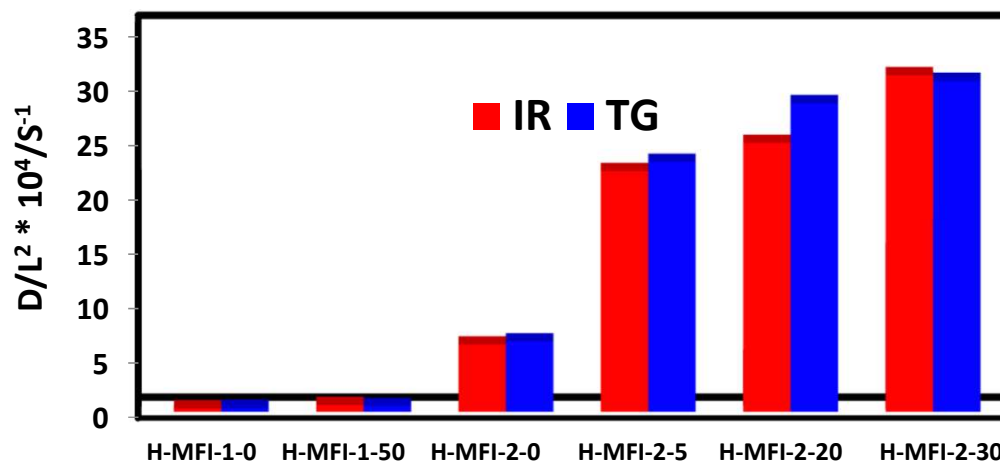

➤ Experimental conditions :

□ $T_{\text{ads}} = 423 \text{ K}$

□ $P_{\text{isooctane}} = 0,012 \text{ bar}$

Similar diffusivities determined by TG and IR indicates good connectivity between meso- and microporous networks



Application to hierarchical H-MFI zeolites

Hierarchization by alkaline treatment (desilication)

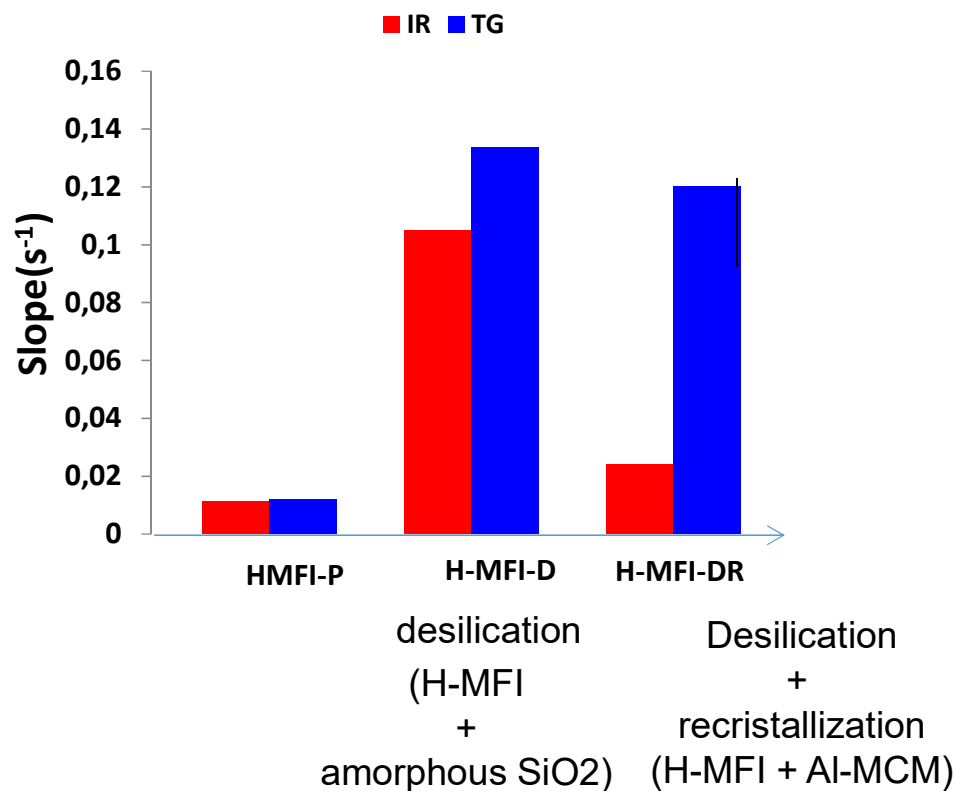
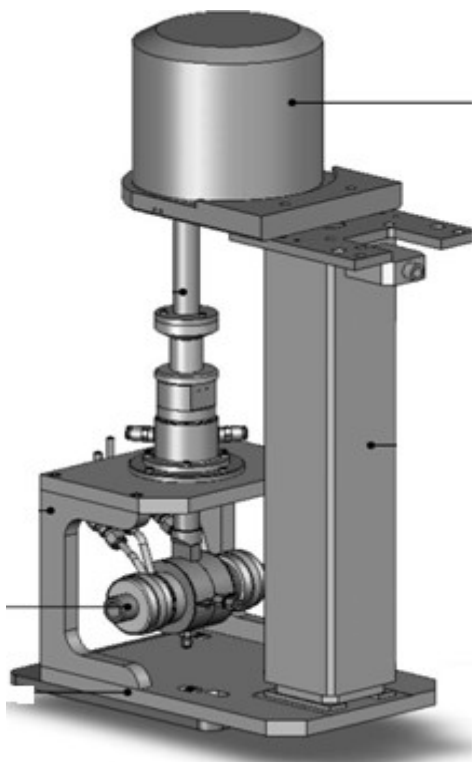

Desilication improves diffusivity to OH groups => hierarchical material
Subsequent recrystallisation : pore blocking of MFI by Al-MCM crystals
Good relationship of apparent diffusivities and isooctane cracking activities !

AGIR(OH) : a good diagnostic tool of hierarchization



Conclusions & Perspectives

IR operando spectroscopy can be used to quantify **diffusivities**, **adsorption** and **intrinsic kinetic** parameters of model reactions

Strong limitations for more complex/real systems...

Current work:

Combine **IR and DSC** to determine more accurate adsorption parameters

Use **chemometrics** (hard-soft MCR ALS) on complex systems

Combine IR and ab initio methodologies to derive **hybrid micro-kinetic models**

Further reading:

Kadam et al. , *Chem. Eur. J.*, **2018** 5489-5492

Li et al. *ACS Catal.* **2016** 6 4536–4548

Shu et al. *Topics Catal.* **2015** 58 334-342

Bordiga et al. *Chem. Soc. Rev.* **2015** 44 7262-7341



Aknowledgements

- **LCS** Alexandre Vimont, Philippe Bazin, Sergey Sirotin, Haoguang Li, Shashikant Kadam, Dusan Stosic, Abdelhafid Ait Blal, ...
- **WR Grace** Richard F. Wormsbecher
- **Région Normandie, ANR, CNRS, FEDER**

GRACE



See J. Schnee, P. Bazin & R. Debek communications!





Selectivities and activation entropies of individual cracking reactions

- Previous parameters determined for overall cracking ($k_{tot} = \sum k_i$)
- For alkanes larger than propane: several cracking reactions

Example: pentane: 2 distinct CC bonds, 3 sets of products

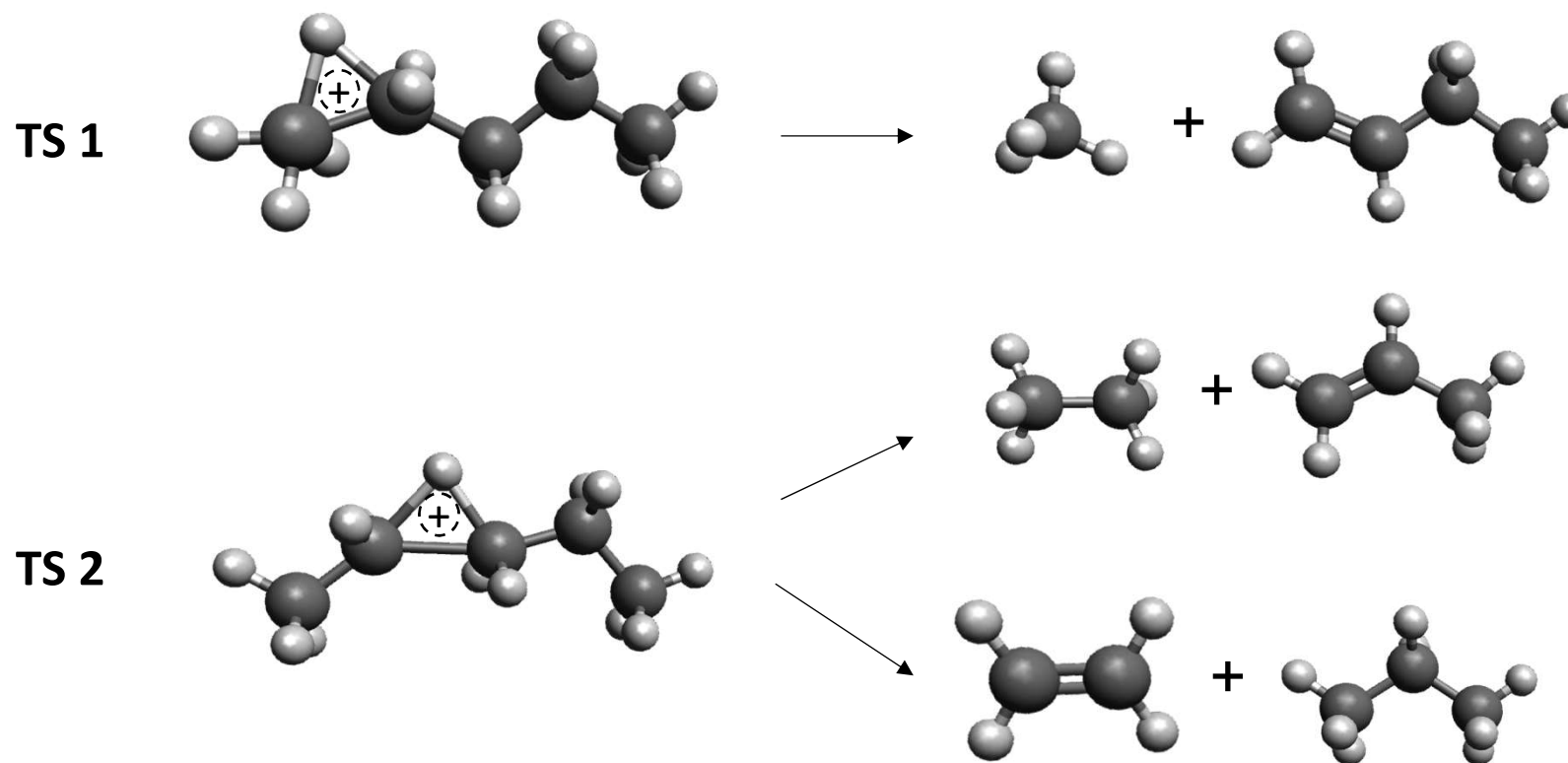



Individual Cracking Reactions

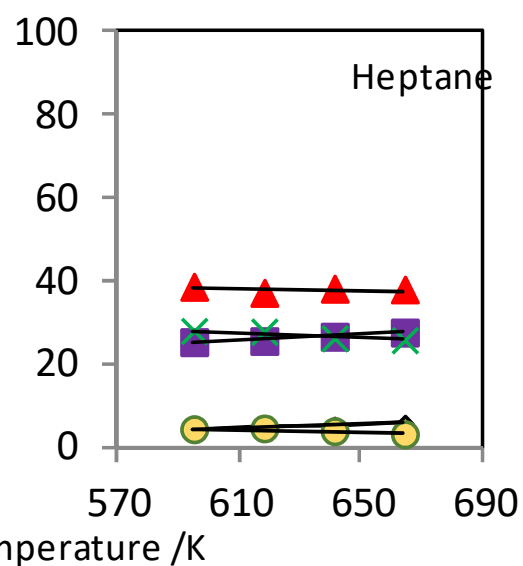
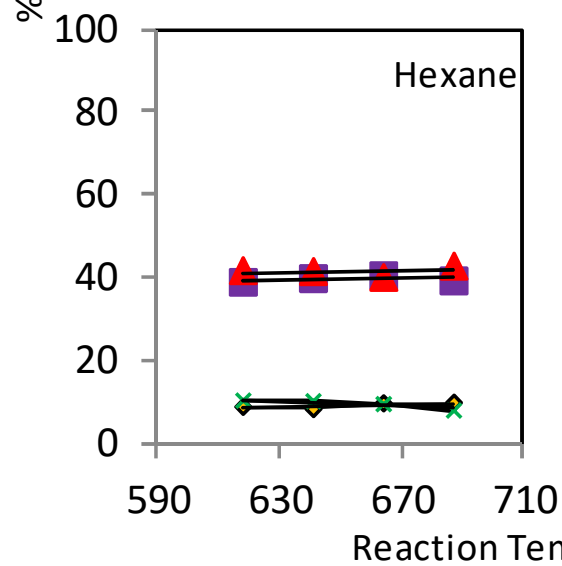
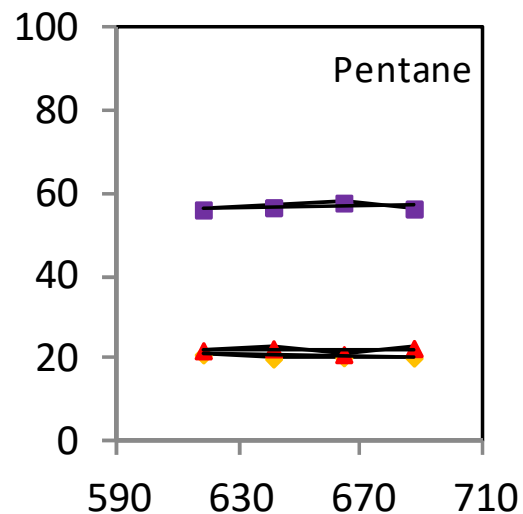
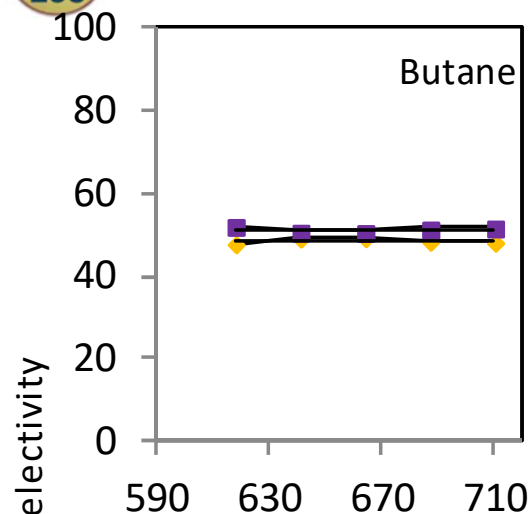

- Constant Selectivities with Temperature
- Constant E_a
- Selectivities are also governed by ΔS^\ddagger

CH₄(◆), C₂H₆(■), C₃H₈(▲), C₄H₁₀(●) and C₅H₁₂(X).



An apparently simple product distribution...

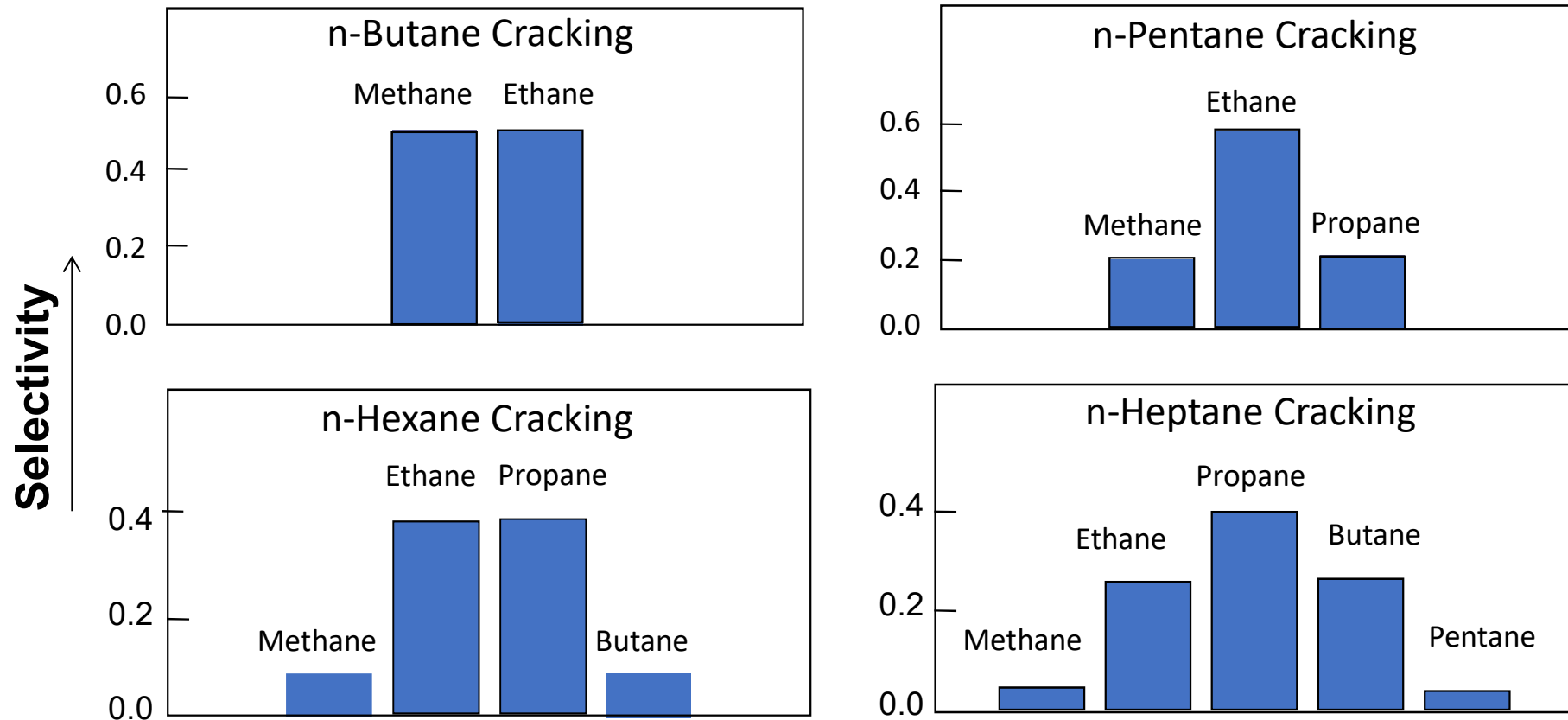

- Similar distributions reported in the literature
- Deviations from symmetric distribution:
 - High conversions (secondary reactions)
 - CHA zeolite
- Relationship between the broken CC bond and the products ?



How products are related to the C+ intermediate ?

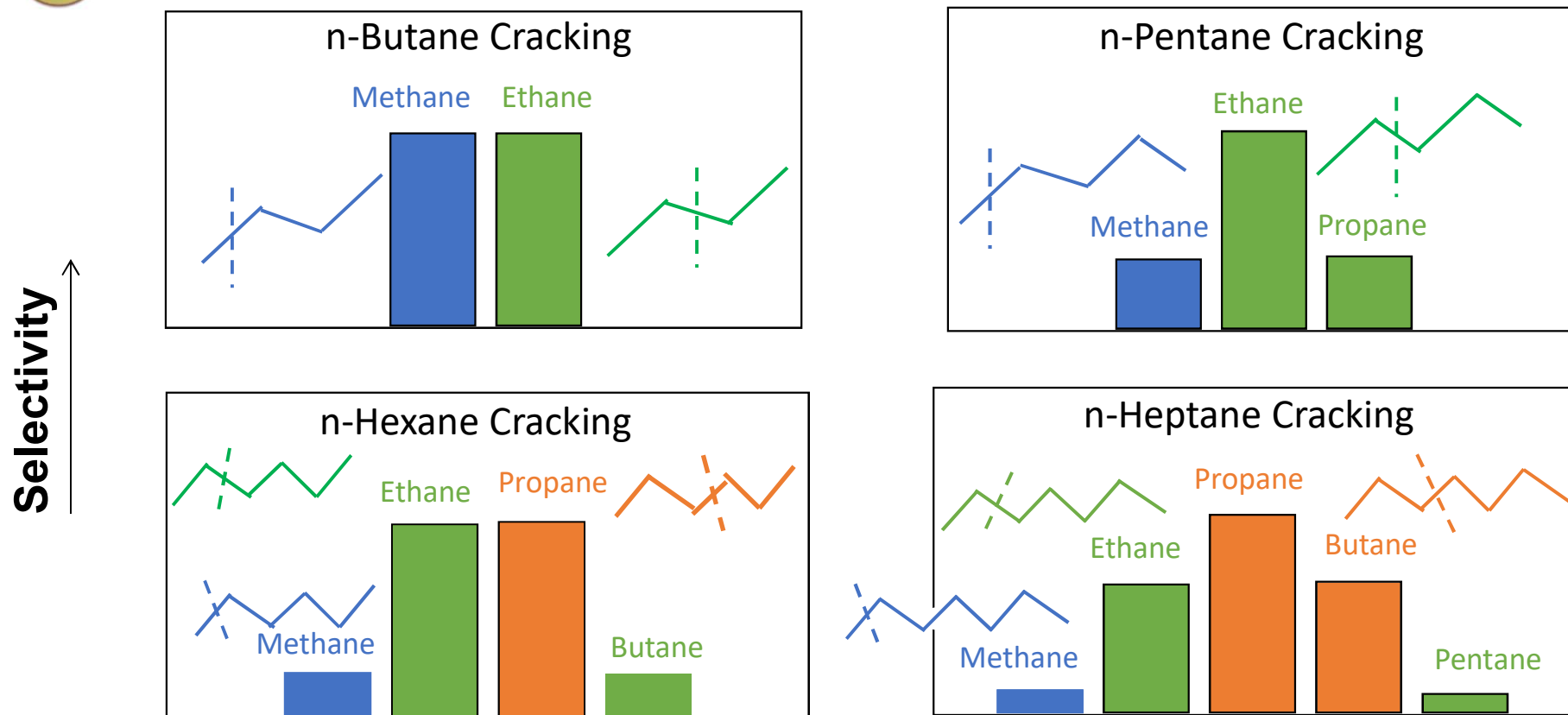

Products from **same intermediate** have **distinct selectivities**

Products having **same selectivities** come from **distinct intermediate**

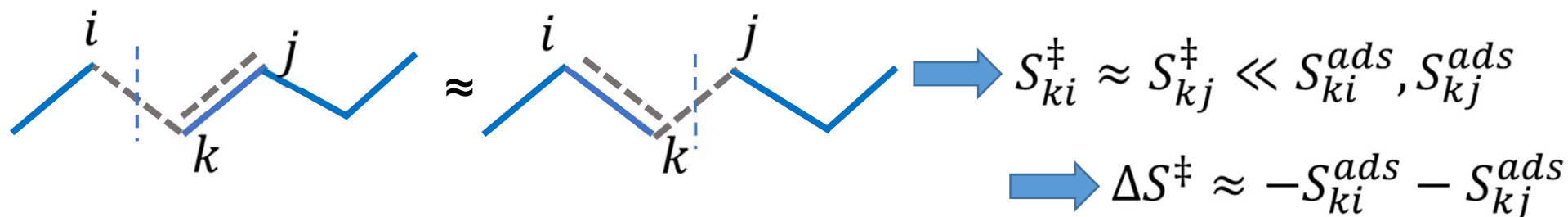

Activation entropy governed by the adsorbed state



Products with same yields

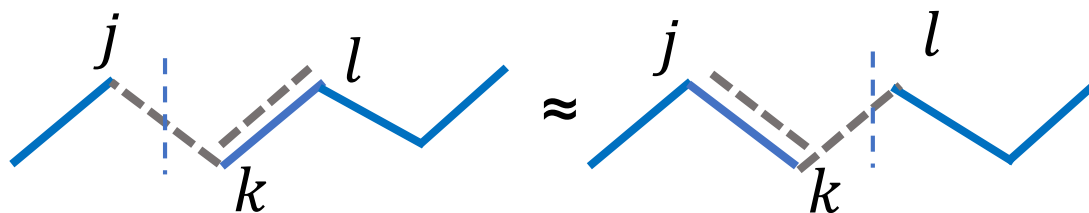

« Individual » activation entropies: $\Delta S_i^\ddagger = S_i^\ddagger - S_{i_{ads}}$

- Same TS entropy / Distinct *reactant* state entropies characterized by the interaction of the acid site with the central (*k*) atom ?
- Single *reactant* state / Equal contributions of Bonds *ik* and *kl* to both TS entropies ?
 - Internal degree of freedom hindered at the TS ($q_{ik}^\ddagger \sim q_{kl}^\ddagger \sim 1$)
 - Other internal modes not too much affected

$$\Delta S_i^\ddagger = R \ln \frac{Q^\ddagger}{Q_{ads}} \sim \ln \frac{1}{q_{ik}^{ads} q_{kl}^{ads}}$$

- ΔS^\ddagger is governed by the **adsorbed state**
- Structure-activity relationships explained by more hindered internal rotations due to confinement ?

