



**HAL**  
open science

## Synergetic effect of microwave plasma and catalysts in CO<sub>2</sub> methanation

Bachar Alrafei, Jose Delgado-Liriano, Alain Ledoux, Isabelle Polaert

► **To cite this version:**

Bachar Alrafei, Jose Delgado-Liriano, Alain Ledoux, Isabelle Polaert. Synergetic effect of microwave plasma and catalysts in CO<sub>2</sub> methanation. Ampere 2019, Sep 2019, Valencia, Spain. 10.4995/Ampere2019.2019.9806 . hal-02410056

**HAL Id: hal-02410056**

**<https://normandie-univ.hal.science/hal-02410056v1>**

Submitted on 29 May 2024

**HAL** is a multi-disciplinary open access archive for the deposit and dissemination of scientific research documents, whether they are published or not. The documents may come from teaching and research institutions in France or abroad, or from public or private research centers.

L'archive ouverte pluridisciplinaire **HAL**, est destinée au dépôt et à la diffusion de documents scientifiques de niveau recherche, publiés ou non, émanant des établissements d'enseignement et de recherche français ou étrangers, des laboratoires publics ou privés.



Distributed under a Creative Commons Attribution - NonCommercial - NoDerivatives 4.0 International License

## SYNERGETIC EFFECT OF MICROWAVE PLASMA AND CATALYSTS IN CO<sub>2</sub> HYDROGENATION INTO HIGH ADDED-VALUE MOLECULES

B. Alrafei, J. Delgado, A. Ledoux, I. Polaert.

<sup>1</sup>Normandie University, INSA Rouen, LSPC, EA 4704, Avenue de l'Université – Saint-Étienne-du-Rouvray cedex 76801 France  
e-mail: [isabelle.polaert@insa-rouen.fr](mailto:isabelle.polaert@insa-rouen.fr)

**Keywords:** Microwave, Plasma, CO<sub>2</sub> methanation, Catalyst.

### Introduction

The concept known as *Power-to-gas* (PtG) has shown an outstanding importance in terms of renewable energy storage and CO<sub>2</sub> conversion into high added-value products such as methane and methanol. The production of electricity from renewable energy is very dependent on weather and environmental conditions, thus the large excess of electricity can be used in water electrolysis in order to produce hydrogen and oxygen, which can be used directly or as intermediates in chemical reactions. The complexity of hydrogen storage due to its explosive properties make the *Power-to-gas* concept a very suitable process to store the hydrogen and reduce CO<sub>2</sub> emissions at the same time by reacting hydrogen with CO<sub>2</sub> to form methane or methanol.

CO<sub>2</sub> is a very stable molecule due to its inert electronic structure, and its conversion requires various forms of energy supply (heat, light, etc.) to overcome kinetic limitations. Conventional processes operate under high temperatures and pressures, which leads to fast deactivation of the catalyst and temperature control issues in the reactor due to the high exothermicity of the reaction.

The coupling of non-thermal plasma with CO<sub>2</sub> hydrogenation reaction is considered very promising in terms of chemical reaction improvement; especially that renewable energy can be the driving force of this technology [1]. The first works were carried out by Russians [2,3] and Italians [4,5]. Different types of plasma were used in order to dissociate CO<sub>2</sub> molecule such as Luminescent, Microwave (MWP), Dielectric Barrier Discharge (DBD) and Corona plasma. Among the different types of plasma, microwave plasma is the most interesting. Fig. 1 shows the energy efficiency as a function of CO<sub>2</sub> conversion for the different types of

plasma. The energy efficiency is defined as:  $\eta = \frac{X_T \cdot \Delta H_r}{SEI}$

With  $X_T$  is the total conversion:  $X_T = y_{CO_2in} \cdot X_{CO_2} + y_{H_2in} \cdot X_{H_2}$

and SEI is the specific energy input :  $SEI(eV / molecule) = \frac{SEI(J \cdot cm^{-3})}{3.92} = \frac{P/F}{3.92}$

where P is the power in W, and F is the input flow rate in cm<sup>3</sup>.s<sup>-1</sup>.

It is clear that higher conversion and efficiency could be achieved using microwave plasma compared to other discharges [6].

A microwave discharge does not require any electrodes to be generated and therefore, the cost of these electrodes and their maintenance is reduced compared to that of glow discharge plasmas or DBD. Microwave plasma can also be generated over a wide pressure range (between 3 mbar and 1 bar). In addition, in the case of microwave plasma, more electrons

and active species are produced compared to other types of plasma [7,8]. This ensures an appropriate environment for a chemical reaction and allows effective dissociation of CO<sub>2</sub>.

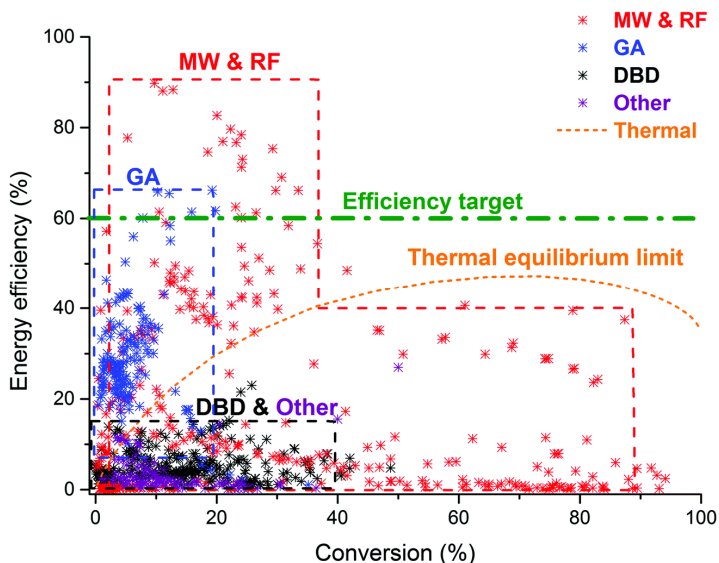

**Fig. 1.** Comparison of the energy efficiency of CO<sub>2</sub> conversion using different plasma types [6]

This work focuses on the hydrogenation of CO<sub>2</sub> into light hydrocarbons (CH<sub>4</sub>, CH<sub>3</sub>OH) under microwave plasma. The synergy between plasma and Ni catalysts supported on alumina was studied. First, the reaction was carried out without any catalyst and the effect of the CO<sub>2</sub>/H<sub>2</sub> ratio, total flow rate and incident power were evaluated. Then, MWP was coupled with Ni catalysts that we prepared, characterized and tested on conventional CO<sub>2</sub> methanation reaction [9]. Several configurations were studied by changing the position of the catalyst bed. The results obtained were compared to conventional catalytic tests performed with the same catalysts.

### Experimental set-up

The MWP set-up used in the present work is illustrated in Figure 1. This laboratory scale set-up can be divided into two parts: the plasma generation and the gas feed and circuit.

The plasma generation set up includes a microwave generator (magnetron) with a maximum power of 3000 W working at 2.45 GHz frequency. It includes an isolator with a reflected power crystal detector to protect the magnetron from reflected power. Manual impedance tuners and a manual sliding short-circuit were used to ensure a high energy supply into the plasma zone. The tuners and the sliding short-circuit are used to optimize the transfer of energy from the source to the load. A microwave cavity plasma generator (downstream plasma source) was used to ignite the plasma in a quartz tube with 30 mm inner diameter. Two tubes with the same diameter were used, one with a glass frit (pore size 2) and another without the frit. The cavity was cooled simultaneously with compressed air and water. The tube wall was cooled using compressed air. A vacuum pump with a minimum pressure of 0.15 mbar was connected to the tube. The operating pressure was varied between 70 and 800 Pa.

The gaseous reactants were introduced into the tube using three mass flowmeters. A capacitif pressure sensor was used to measure the pressure into the tube. The temperature of the outgoing air from the cavity was measured using a K type thermocouple, and the one at the surface wall was measured using an optic fiber. The outlet gas was analysed using gas chromatograph equipped with three columns and two detectors (FID, TCD).

### Experimental procedure

First, the plasma was ignited in the reactor using a low flow of nitrogen while applying a power between 800 W and 1000 W. The pressure in the reactor at this stage was between 100 and 200 Pa. After ignition, the plasma was centered using the manual sliding short-circuit, and the reflected power was minimized.

Later, the reactants ( $\text{CO}_2$  and  $\text{H}_2$ ) were introduced into the reactor, and nitrogen flow was adjusted to keep a  $\text{CO}_2/\text{H}_2/\text{N}_2$  ratio equal to 1/4/5. Then, the reflected power was minimized again by means of the sliding short-circuit and the tuners if necessary.

As the analysis was done using an off-line GC, the gas at the outlet of the pump was collected using sampling bags and then analyzed in the GC.

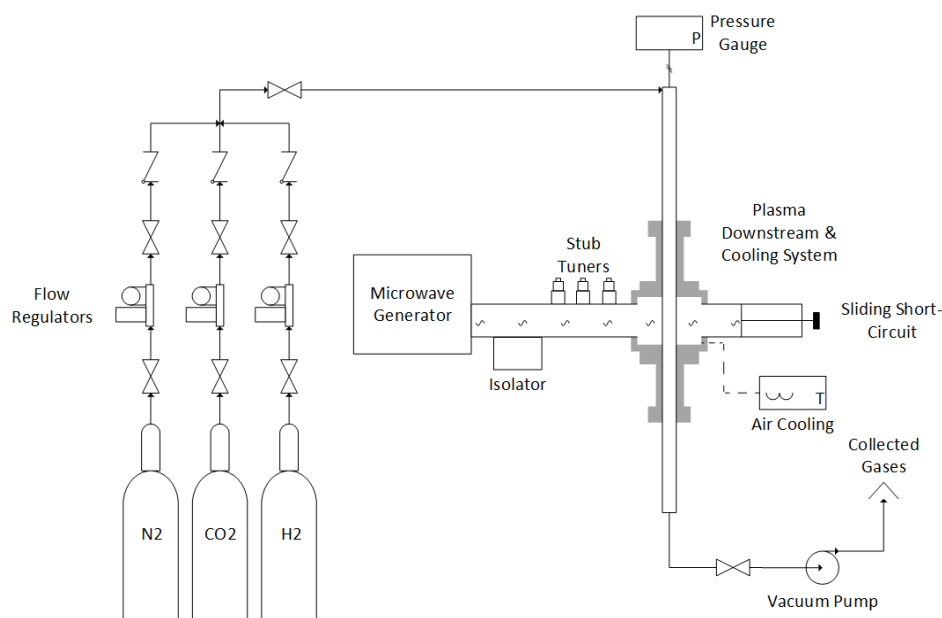

**Fig 1.** Schematic of the laboratory scale MWP set-up

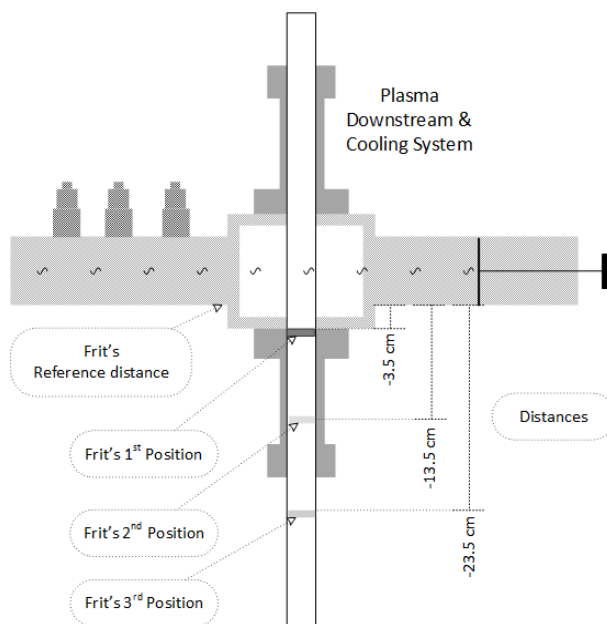

Fig 2. Different frit positions in the quartz tube

## Results and discussion

### Catalyst-free CO<sub>2</sub> hydrogenation with MWP

First, CO<sub>2</sub> hydrogenation was evaluated in the hollow tube without any catalyst. Figure 1 and 2 present the effect of total flow rate and incident power on CO<sub>2</sub> conversion and CO selectivity. A fixed H<sub>2</sub>/CO<sub>2</sub>/N<sub>2</sub> ratio equal to 4/1/5 was used, and the total flow rate was varied between 100 and 400 mL/min. The results showed that the increase in total flowrate induces a strong decrease in CO<sub>2</sub> conversion. This can be directly related to the decrease in reactants residence time in the plasma column when the total flow rate increases. The increase of total flow rate induced an increase of the pressure in the reactor, which results in more contracted plasma, shorter plasma column was then observed.

CO<sub>2</sub> conversion is also greatly affected by the microwave input power. It is worth to mention that the absorbed power is very close to the incident power thanks to the optimization via the short circuit and the tuners. CO<sub>2</sub> conversion is favored at higher input power between 300 W and 500 W. At 600 W, nearly the same conversion was obtained, which means that an equilibrium of CO<sub>2</sub> dissociation in the plasma was achieved. The increase of CO<sub>2</sub> conversion with input power can be related to a higher specific energy input, which implies highly energetic electrons that collide with gas molecules and dissociate CO<sub>2</sub>. CO<sub>2</sub> conversion reached a maximum value of 84 % using a total flowrate of 100 mL/min and an incident power equal to 600 W.

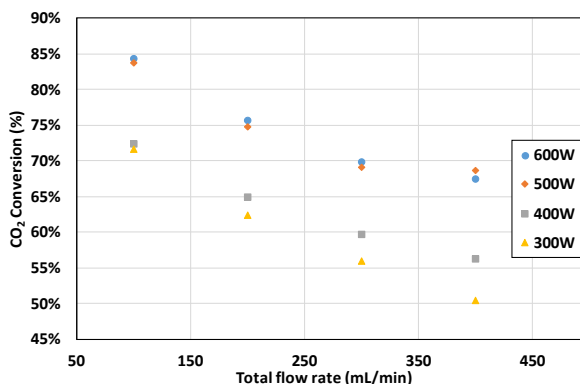

**Fig 3.** Effect of total flow on CO<sub>2</sub> conversion, Hollow tube, H<sub>2</sub>/CO<sub>2</sub>/N<sub>2</sub>=4/1/5

Looking at GC analysis results, it was observed that CO is the main product of the reaction. Carbon dioxide was mainly reduced into CO in the plasma. Fig.4 shows that CO selectivity was not much affected neither by the total flow rate, nor by the incident power, and reaches about 90% in each case. However, it also means that about 10% of the converted carbon dioxide leads to other carbonated species that can be of great interest.

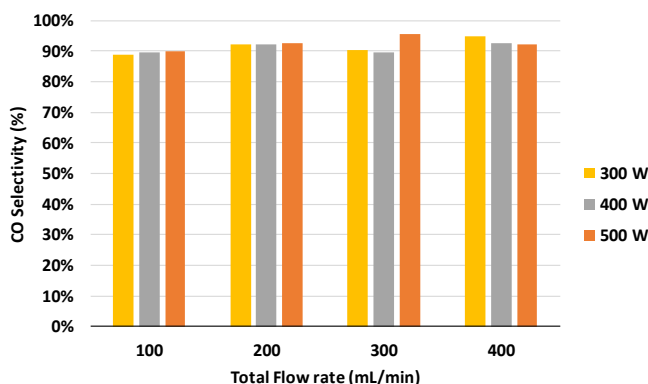

**Fig 4.** Effect of total flow rate on CO selectivity, Hollow tube, 500W, H<sub>2</sub>/CO<sub>2</sub>/N<sub>2</sub>=4/1/5

Figure 5 shows methane and methanol production in ppm. Methanol production was higher than methane (~1500 ppm) during CO<sub>2</sub> hydrogenation in the plasma. The production of methane was not much affected by microwave power, but more affected by the total flow: it increased by decreasing total flow rate from 400 to 100 mL/min. Methanol production was more dependent on the power. It showed a maximum of 1632 ppm at 400W. Small amounts of propane (100-150 ppm) were also observed during GC analysis.

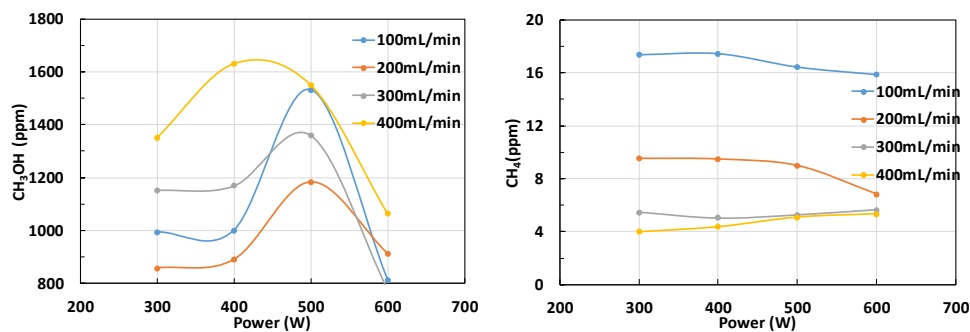

Fig 5. Methanol and methane production in ppm

The fraction of nitrogen in the feed gas was varied between 20 % and 50 % in order to study the effect of inlet gas dilution on CO<sub>2</sub> conversion. The flow rate of H<sub>2</sub> and CO<sub>2</sub> remained fixed at 160 mL/min and 40 mL/min respectively, and a power of 300 W was used (Figure 6). It was found that the increase in N<sub>2</sub> fraction in the inlet gas induced a moderate decrease in CO<sub>2</sub> conversion. This can be explained by a competitive absorbance of energy between N<sub>2</sub> and the other molecules. N<sub>2</sub> is known as a high energetic molecule in plasma, it can store energy by vibration and rotation and thus, a part of the incident power is not used to dissociate CO<sub>2</sub>, but is consumed by N<sub>2</sub>.

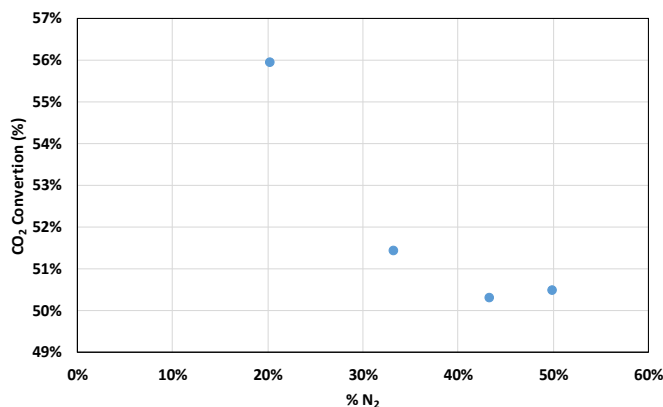

Fig 6. Nitrogen dilution effect on CO<sub>2</sub> conversion, Hollow tube, 300 W, F<sub>H2</sub> =160 mL/min, F<sub>CO2</sub>=40 mL/min

### Plasma-assisted catalytic CO<sub>2</sub> hydrogenation

The catalyst 20%Ni/Al<sub>2</sub>O<sub>3</sub> calcined at 450 °C prepared and characterized in [9] was used in the present study. A comparison between experiments made with the hollow tube, 1 g and 5 g of the catalyst is presented in Figure 7 in terms of CO<sub>2</sub> conversion, CH<sub>4</sub> and CH<sub>3</sub>OH production, and CH<sub>3</sub>OH/CH<sub>4</sub> ratio. CO<sub>2</sub> conversion increased from 75 % to more than 90 % when using nickel catalyst with plasma. This increase in CO<sub>2</sub> conversion results from the effect of coupling plasma with nickel catalyst. As well, methane and methanol production increased after catalyst addition. Methanol production increased from 900 ppm to 1900 ppm, and methane production from 6 ppm to 25 ppm.

The CH<sub>3</sub>OH /CH<sub>4</sub> ratio decreased when coupling the plasma with catalyst. This means that the use of catalyst increased the rate of methane production more than methanol one. The amount of methane produced using plasma-catalyst is 5 times greater than the amount produced using the plasma alone, while that of methanol is 2 times greater than the amount produced using plasma.

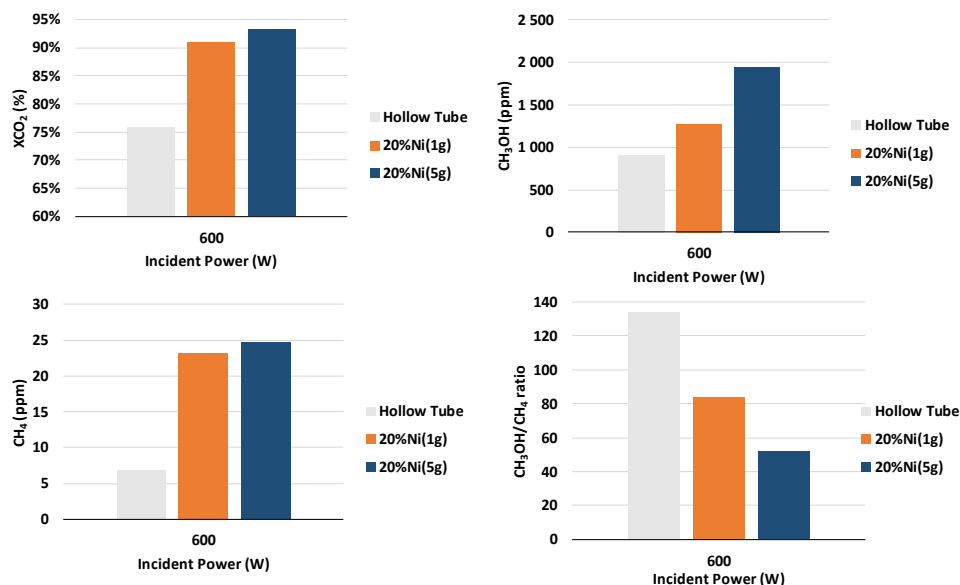

Fig 7. Catalytic CO<sub>2</sub> hydrogenation using MWP, 600 W, 400mL/min, H<sub>2</sub>/CO<sub>2</sub>/N<sub>2</sub> =4/1/5

The catalyst bed position was varied in order to evaluate the effect of plasma on catalyst activity and reported in Table 1. A higher CH<sub>3</sub>OH /CH<sub>4</sub> ratio was found when putting the catalyst in the position -13.5 cm, which is further from the center of plasma. This can be explained by more favorable thermal conditions in this position for CO<sub>2</sub> hydrogenation into methanol.

Table 1. Effect of catalyst bed position on CH<sub>4</sub>/CH<sub>3</sub>OH ratio

	Catalyst position (cm)	
	-10.3	-13.5
CH <sub>3</sub> OH /CH <sub>4</sub>	38	431

### Conclusion

Microwave plasma technology can be efficiently used to convert carbon dioxide into carbon monoxide. By adding Ni catalyst into the plasma, a synergetic effect is observed and light hydrocarbons such as methanol and methane, propane are produced. The results of this study clearly show that the reduction of CO<sub>2</sub> is governed by a combined effect between the plasma induced electronic excitation and catalysis at the reduced nickel particles surface. Optimization is possible by varying the energy input, the flowrates and the relative position between the catalytic bed and the plasma.



## References

- [1] Y. Qin, G. Niu, X. Wang, D. Luo, Y. Duan, Status of CO<sub>2</sub> conversion using microwave plasma, *Journal of CO<sub>2</sub> Utilization*. 28 (2018) 283–291. doi:10.1016/j.jcou.2018.10.003.
- [2] A. Fridman, *Plasma Chemistry* by Alexander Fridman, Cambridge Core. (2008). doi:10.1017/CBO9780511546075.
- [3] V.A. Legasov, V.K. Zhivotov, E.G. Krashennnikov, M.F. Krotov, B.I. Patrushev, V.D. Rusanov, G.V. Rykunov, A.M. Spektor, A.A. Fridman, G.V. Sholin, Nonequilibrium plasma-chemical process of the decomposition of CO<sub>2</sub> in HF and UHF discharges, *Akademiia Nauk SSSR Doklady*. 238 (1978) 66–69.
- [4] P. Capezzuto, F. Cramarossa, R. D'Agostino, E. Molinari, Contribution of vibrational excitation to the rate of carbon dioxide dissociation in electrical discharges, *J. Phys. Chem.* 80 (1976) 882–888. doi:10.1021/j100549a024.
- [5] M. Capitelli, E. Molinari, Kinetics of dissociation processes in plasmas in the low and intermediate pressure range, in: *Plasma Chemistry II*, Springer Berlin Heidelberg, 1980: pp. 59–109.
- [6] R. Snoeckx, A. Bogaerts, Plasma technology – a novel solution for CO<sub>2</sub> conversion?, *Chem. Soc. Rev.* 46 (2017) 5805–5863. doi:10.1039/C6CS00066E.
- [7] J.F. de la Fuente, S.H. Moreno, A.I. Stankiewicz, G.D. Stefanidis, Reduction of CO<sub>2</sub> with hydrogen in a non-equilibrium microwave plasma reactor, *International Journal of Hydrogen Energy*. 41 (2016) 21067–21077. doi:10.1016/j.ijhydene.2016.08.032.
- [8] A. Vesel, M. Mozetic, A. Drenik, M. Balat-Pichelin, Dissociation of CO<sub>2</sub> molecules in microwave plasma, *Chemical Physics*. 382 (2011) 127–131. doi:10.1016/j.chemphys.2011.03.015.
- [9] B. Alrafe'i, I. Polaert, A. Ledoux, F. Azzolina-Jury, Remarkably stable and efficient Ni and Ni-Co catalysts for CO<sub>2</sub> methanation, *Catalysis Today*. (2019). doi:10.1016/j.cattod.2019.03.026.