



**HAL**  
open science

## **In situ X-ray for monitoring crystallization and phase transitions in suspension: In-situX®**

Simon Clevers, A. Lafontaine, G. Baaklini, M. Schindler, Morgane Sanselme,  
Yohann Cartigny, V. Dupray, Gérard Coquerel

### ► To cite this version:

Simon Clevers, A. Lafontaine, G. Baaklini, M. Schindler, Morgane Sanselme, et al.. In situ X-ray for monitoring crystallization and phase transitions in suspension: In-situX®. BIWIC 2019 International Workshop on Industrial Crystallization, Aug 2019, Rayong, Thailand. . <hal-02295903>

**HAL Id: hal-02295903**

**<https://normandie-univ.hal.science/hal-02295903v1>**

Submitted on 24 Sep 2019

**HAL** is a multi-disciplinary open access archive for the deposit and dissemination of scientific research documents, whether they are published or not. The documents may come from teaching and research institutions in France or abroad, or from public or private research centers.

L'archive ouverte pluridisciplinaire **HAL**, est destinée au dépôt et à la diffusion de documents scientifiques de niveau recherche, publiés ou non, émanant des établissements d'enseignement et de recherche français ou étrangers, des laboratoires publics ou privés.



HAL Authorization



# In situ X-ray for monitoring crystallization and phase transitions in suspension: In-situX®



S. Clevers, A. Lafontaine, G. Baaklini, M. Schindler, M. Sanselme, Y. Cartigny, V. Dupray and G. Coquerel

Laboratoire Sciences et Méthodes Séparatives, EA3233, Université de Rouen Normandie, 76821 Mont Saint Aignan, France. valerie.dupray@univ-rouen.fr



## Introduction

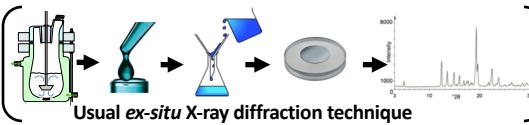

Usual ex-situ X-ray diffraction technique



Not suitable for:

- In-situ analyses
- Metastable phase
- Efflorescent solvate
- Crystals in suspension
- Transient states

## Aim of the study

To highlight, through different examples, the possibilities of In-situX® as analytical tool able to solve academic as well industrial problems

## Conclusion

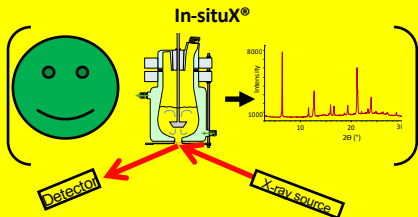

- No need for sampling (cytotoxic compounds, radioactive elements, low temperature crystallization, efflorescent solvates, CO<sub>2</sub>, O<sub>2</sub>, light, moisture sensitive compounds)
- Laboratory X-ray Source

Solid – solid transition studies of all sorts:

- Polymorphism (kinetics of transition during slurring)
- De/resolution (peritectic transitions in binary, ternary systems, etc.)
- Co-crystal formation
- Host Guest associations
- Clathrates

- Optimization of the resolution of chiral molecules
- Optimization of the filterability by means of temperature cycling

## DMU/H<sub>2</sub>O- Polymorphic transition

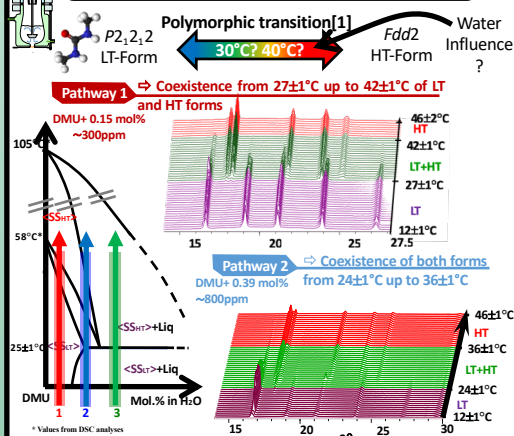

$\Rightarrow$  evidence of a metatectic invariant [2]  
 $\Rightarrow$  Water as impurity strongly impacts the phase transition of DMU  
 Dried DMU  $\rightarrow T_i = 58^{\circ}\text{C}$   
 ~300ppm + DMU  $\rightarrow T_i = 27^{\circ}\text{C}$ !

## Detection of solvate

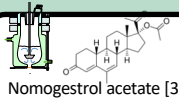

$\rightarrow$  Detection of highly efflorescent solvate

Determination of peritectic invariants  $\rightarrow$  Non-solvated phase can be obtained directly in suspension

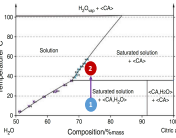

$\rightarrow$  Possibility to dehydrate citric acid monohydrate above this temperature directly in aqueous solution.

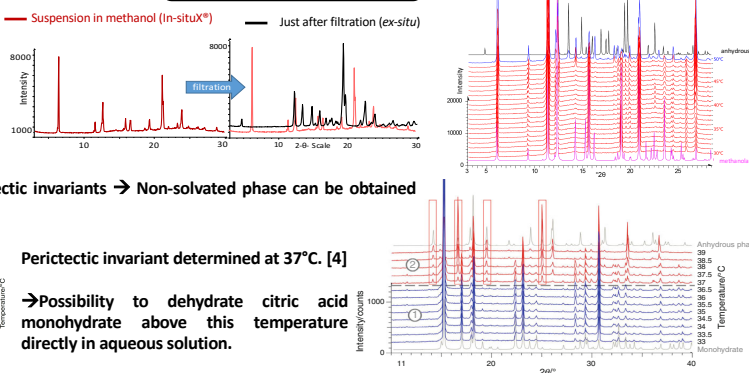

## Vapor/solid equilibria

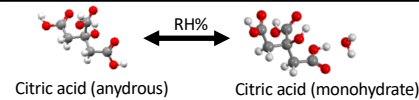

At 25°C [4]:

- $\rightarrow$  Hydration detected at 73%RH (DVS 73.4%) and completed at 78%
- $\rightarrow$  Above deliquescence: significant decrease of peak intensities
- $\rightarrow$  Useful information for the storage conditions

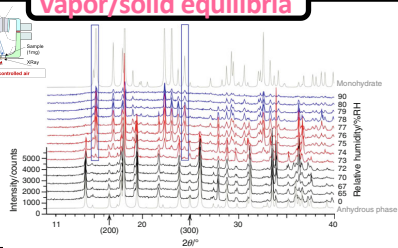

## In-situX® - Principle

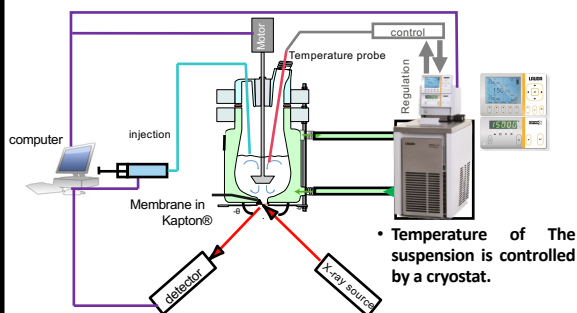

**Diffractionmeter [5]:**  
 Geometry:  $-\theta/-\theta$   
 Detector: Lynx eyes™  
 X-ray tube: anticathode in copper

Computer-controlled (stirring rate, chemical injection, temperature) by Labview® software

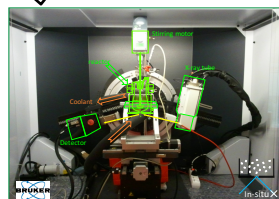

## Measure in suspension

$\Rightarrow V = 40\text{mL}, V_{\text{max}} = 100\text{mL}$

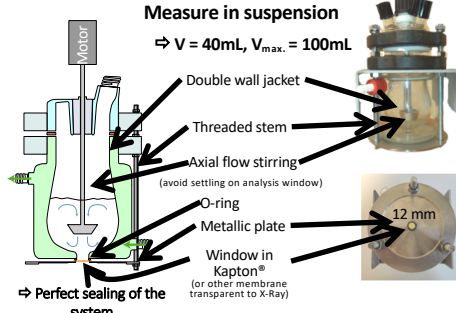

## Vapor/solid equilibria

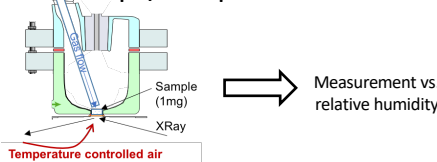

## AFRODISM [6]:

-70°C  $\leftarrow$  Temperature range  $\rightarrow$  +70°C

- Temperature control of the exterior of the reactor
- Anti-frosting and anti-condensation on the Kapton window

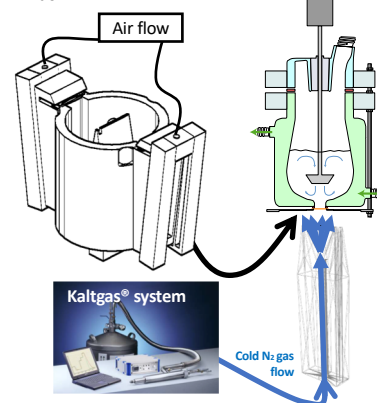

## References

[1] C. Näther, C. Döring, I. Jess, P. G. Jones, and C. Taouss, Acta Crystallogr B Struct Sci, vol. 69, no. 1, 2012.  
 [2] G. Baaklini et al. "Depression of the polymorphic transition temperature of 1,3-dimethylurea (DMU) by insertion of hundreds of ppm of water in the crystal lattices and crystal structure determination of DMU monohydrate." to be published

[3] A. Lafontaine, PhD Thesis, Université de Rouen, 2013

[4] A. Lafontaine, M. Sanselme, Y. Cartigny, P. Cardinael, and G. Coquerel, Journal of Thermal Analysis, vol. 112, no. 1, pp. 307–315, Nov. 2012.

[5] G. Coquerel, M. Sanselme, and A. Lafontaine, US9255898B2 patent, 2014

[6] G. Coquerel, S. Clevers EP18305580.5 patent, 2018