



HAL
open science

Application of the concept of Linear Free Energy Relationships to the hydrogenation of levulinic acid and its corresponding esters

Yanjun Wang, Mariasole Cipolletta, Lamiae Vernières-Hassimi, Valeria Casson-Moreno, Sébastien Leveneur

► **To cite this version:**

Yanjun Wang, Mariasole Cipolletta, Lamiae Vernières-Hassimi, Valeria Casson-Moreno, Sébastien Leveneur. Application of the concept of Linear Free Energy Relationships to the hydrogenation of levulinic acid and its corresponding esters. *Chemical Engineering Journal*, 2019, 374, pp.822-831. 10.1016/j.cej.2019.05.218 . hal-02151602

HAL Id: hal-02151602

<https://normandie-univ.hal.science/hal-02151602v1>

Submitted on 25 Oct 2021

HAL is a multi-disciplinary open access archive for the deposit and dissemination of scientific research documents, whether they are published or not. The documents may come from teaching and research institutions in France or abroad, or from public or private research centers.

L'archive ouverte pluridisciplinaire **HAL**, est destinée au dépôt et à la diffusion de documents scientifiques de niveau recherche, publiés ou non, émanant des établissements d'enseignement et de recherche français ou étrangers, des laboratoires publics ou privés.



Distributed under a Creative Commons Attribution - NonCommercial 4.0 International License

**Application of the concept of Linear Free Energy Relationships to the Hydrogenation of
Levulinic acid and its corresponding esters**

Yanjun Wang¹, Mariasole Cipolletta², Lamiae Vernières-Hassimi¹, Valeria Casson-Moreno²,
Sébastien Leveneur^{1,3*}

¹*Normandie Univ, INSA Rouen, UNIROUEN, LSPC, EA4704, 76000 Rouen, France, E-mail:
sebastien.leveneur@insa-rouen.fr*

²*Dipartimento di Ingegneria Chimica, Civile, Ambientale e dei Materiali, Alma Mater
Studiorum—Università di Bologna, via Terracini 28, 40131 Bologna, Italy*

³*Laboratory of Industrial Chemistry and Reaction Engineering, Johan Gadolin Process
Chemistry Centre, Åbo Akademi University, Biskopsgatan 8, FI-20500 Åbo/Turku, Finland.*

Abstract.

Biomass valorization to chemicals, biofuels or materials will be more and more important during this century. Production of γ -valerolactone (GVL) from the hydrogenation of levulinic acid is a good illustration of this tendency. GVL can also be produced from alkyl levulinates hydrogenation. Can we find a relationship between the structure and the kinetics of this reaction? Can we predict the kinetics of any alkyl levulinates by knowing the kinetics of another alkyl levulinate? This paper has studied these two questions by developing a kinetic model including the effect of gas-liquid mass transfer. We have demonstrated that the kinetics of hydrogenation of levulinic acid, methyl, ethyl and butyl levulinates to GVL using Ru/C follow the Taft equation, which is derived from Linear Free Energy Relationships. This equation measures the effects of polar and steric on a reaction series. We have demonstrated that polar effect of the reaction series is the most significant effect. This relationship can predict the values of kinetic constants just by knowing their structure.

Keywords: hydrogenation, levulinic acid and esters, γ -valerolactone, kinetic modeling, Taft equation, Linear Free Energy Relationships

1. INTRODUCTION

The use of biomass as feedstock for chemical industries is seen as a credible alternative to substitute fossil-derived feedstock. A well-known example is the use of vegetable oils for the production of biodiesel or the use of sugar cane and corn for the production of bioethanol. Such feedstock are also involved in food-production supply chains, leading to possible ethical conflicts related to the increase of the price of biomass, as happened in Mexico in 2007 during the so-called “tortilla crisis”, when the grain-price increased up to 400% in one year [1]. To overcome the dilemma of food versus fuel, the academic and industrial research have put their efforts to valorize biomass of 2nd generation as, for example, lignocellulosic biomass.

The 2nd generation biomass feedstock is more complicated to valorize because a pretreatment is needed to fractionate/separate biomass components, i.e. lignin, cellulose and hemicellulose. Different industrial processes exist like the production of cellulosic bioethanol or the Biofine process for the production of levulinic acid [2]. According to the US department of energy, levulinic acid (LA) is considered as a top twelve building-block molecules from biomass. In addition, levulinic acid can be upgraded to γ -valerolactone (GVL) which is considered as an important platform molecule [3-4].

As discussed, in the previous articles of our group [3-4], biomass structure is complex and diverse, but it is possible to find a relationship between their structure and reactivity.

During the pretreatment of lignocellulosic biomass (i.e. acid catalysis), different solvents could be used such as water, methanol, ethanol or butanol leading to molecules with different substituents such as levulinic acid, methyl levulinate (ML), ethyl levulinate (EL) or butyl levulinate (BL) [5-11]. Some articles have studied the effect of the substituent alkyl on the production of GVL by using different hydrogen donors such as molecular hydrogen [12] or other chemical species (e.g.

formic acid and alcohols [13-14]. Nevertheless, there is no study in literature trying to establish a correlation between the structure of the alkyl groups and the reactivity of the system.

The production of GVL by hydrogenation of LA or alkyl levulinate has been widely studied by different research groups, some being focused on process intensification [15-16], some on catalytic aspects [17-18] and some on process safety issues [19]. The most common catalyst is Ru/C and one should mention the work of Piskun et al. and Negahdar et al. [20-21] who have developed different kinetic models for the production of GVL by molecular hydrogen.

The corrosive behavior of levulinic acid can be a limit to the industrial-scale implementation of the upgrading process to GVL. For this reason, the study of alkyl levulinate hydrogenation is becoming more and more interesting.

In this work, hydrogenation of LA, EL, ML and BL over Ru/C was studied. GVL was used as a solvent to solubilize all these substrates, whereas water cannot do and alcohol can lead to the side reaction of esterification. Furthermore, GVL as solvent has shown significant advantage in biomass valorization [22-23]. In addition, using GVL as a solvent could simplify the layout of the plant, minimizing the downstream processing.

Herein, the main objective is to link the kinetics of these reactions to the structure of the reactant. As shown in Fig. 1, only the alkyl group R varies between these four compounds. For that, the kinetic constants were tested towards Taft equation, which is derived from Linear Free Energy Relationships.

To verify if hydrogenation of LA and the corresponding levulinates follow the Taft equation, a kinetic model was developed by taking into account gas-liquid mass transfer and the variation of physicochemical properties of the solvent with temperature.

To the best of our knowledge, there are no such studies in the literature. Usually, Taft equation is tested in the presence of only one reaction center and by using apparent kinetic constants [24].

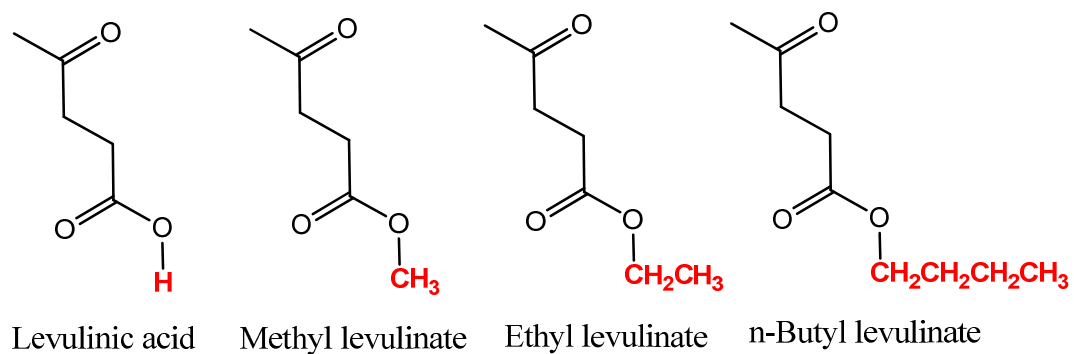

Fig. 1. Structure of LA, ML, EL and BL.

2. MATERIALS AND METHODS

2.1 Chemicals

Levulinic acid (wt% \geq 97%), γ -valerolactone (wt% \geq 99%) and methyl levulinate (wt% \geq 98%) were purchased from Sigma-Aldrich. Ethyl levulinate (wt% \geq 98%) and furfural (wt% \geq 99%) were obtained from Acros Organics. Ru/C (5 wt % ruthenium on activated carbon powder, reduced and 50% water wet) and n-Butyl levulinate (wt% \geq 98%) were provided by the Alfa Aesar. H₂ (>99.999%) was supplied by Linde. Acetone (Analytical grade) was bought from VWR. All the chemicals were used without further treatment.

2.2 Gas-liquid mass transfer and kinetic experiment of hydrogenation

To determine Henry's constant of hydrogen gas in pure γ -valerolactone, a 300ml reactor equipped with efficient gas entrainment impeller, gas reservoir and recording system was used (Fig. 2). Firstly, valve V1 was opened and a desired amount of hydrogen gas was purged into the reservoir from the gas storage bottle through the pressure regulator R1. Secondly, valve V1 was closed and GVL solvent was poured into the reactor and vacuumed to make sure there is no air in the reactor. Thirdly, the reactor was heated to the desired temperature. The reactor temperature was kept constant. Fourthly, valve V2 was opened and the outlet pressure was set to 20 bar by adjusting the pressure regulator R2. Fifthly, the valve V3 was opened and the reactor was purged with hydrogen. Then, the stirring was set at 1000 rpm and valves V2, V3 and regulator R2 were kept open until the end of the experiment to make sure the experiment was performed in isobaric conditions. The experiment lasted for 30 min (to reach the equilibrium), then all the valves were closed and the reactor was cooled down. The pressure and temperature of the reservoir and reactor were recorded

online during the experiment. To evaluate the value of gas-liquid mass transfer coefficients, four experiments in pure GVL were carried out at 20 bars at four temperatures: 373.15K, 393.15K, 413.15 K and 423.15 K.

For the kinetic experiments of hydrogenation of levulinic acid and its esters, the same procedure above described was employed. The desired amount of γ -valerolactone, substrates and Ru/C catalyst were introduced into the reactor. During the reaction, the samples were obtained from valve V_s at different times and reserved for further treatment and analysis. Experimental matrix for the hydrogenation is shown in Table 1.

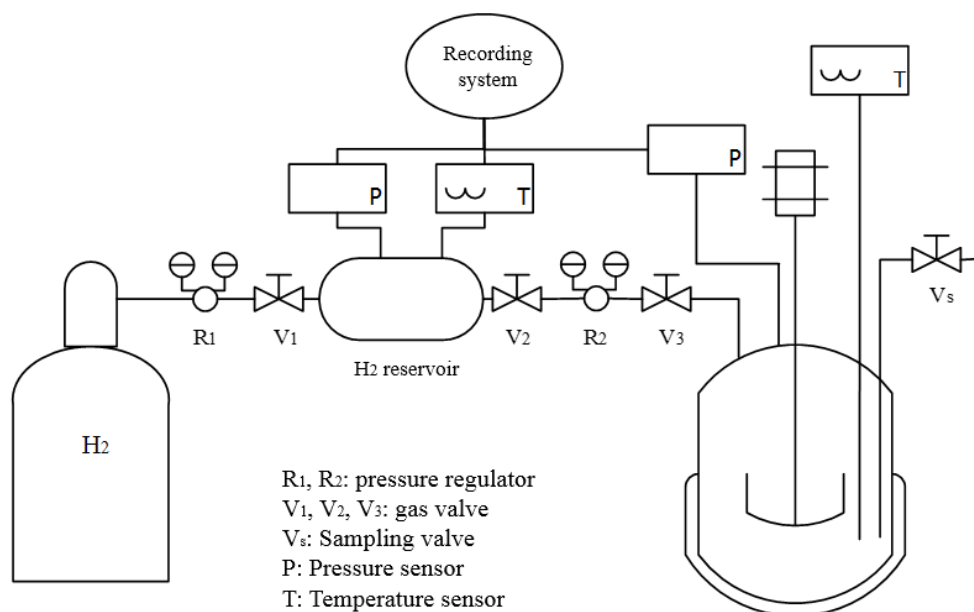

Fig. 2. Reactor scheme.

2.3 Analytical methods

The evolution of density and viscosity with temperature for γ -valerolactone at atmospheric pressure were obtained by using DMA 4100 M and LOVIS 2000 ME microviscometer (Anton

Paar, Austria). Temperature range from 283K-363K with 10K step was employed for the measurement with temperature accuracy of 0.02°C, density accuracy of 0.05 kg·m⁻³, viscosity accuracy of <0.5%.

To identify and quantify the chemical compounds from the hydrogenation kinetic experiments, at first, samples obtained were immediately filtered to separate the Ru/C catalyst in the solution. Then, the colorless samples were diluted in acetone by using furfural as internal standard. Later the diluted solutions were prepared in vials for the further qualification and quantification analysis. The identification of intermediate products from hydrogenation of levulinic acid and its esters, such as HPA, MHP, EHP, BHP, was performed by using GC-MS analysis. Gas chromatography Varian 3900 with Varian Saturn 2000 were applied with a capillary column (ZB-5ms, 30 m × 0.32 mm internal diameter × 0.25 μm film thickness). Helium (99.99%) was used as carrier gas at a constant flow rate of 1.0 mL·min⁻¹. The temperature of the injector and the detector was set at 270 °C. The oven temperature was programmed as 35 °C (3 min)-15 °C·min⁻¹-300°C. The injection volume was 5 μL, and the split ratio was 30:1.

The concentration of levulinic acid and its esters, γ-valerolactone and intermediate products was obtained from GC analysis. Bruker Scion GC436 gas chromatography (GC) equipped with FID detector (flame ionization detector), an autosampler and capillary column (Rxi-5ms, 30 m × 0.32 mm internal diameter × 0.25 μm film thickness) were used. Helium (99.99%) was used as carrier gas at a constant flow rate of 1.2 mL·min⁻¹. Other configurations of GC methods were the same with the GC-MS analysis. The standard deviation of the measured concentrations was found to be lower than 0.70 % showing the high repeatability of the analysis.

Table 1. Experimental matrix for the kinetic study.

Substrate	Run	Initial concentration mol/m ³	Initial liquid mass kg	Temperature °C	Catalyst amount (dry) kg	H ₂ pressure bar
LA	1	984.7	0.1267	100	0.0014	20
	2	893.3	0.1267	130	0.0014	20
	3	1818.2	0.1279	110	0.0007	20
	4	1921.3	0.1279	140	0.0007	20
ML	5	929.5	0.1256	100	0.0014	20
	6	953.4	0.1256	120	0.0014	20
	7	1908.3	0.1257	100	0.0007	20
	8	1875.0	0.1257	140	0.0007	20
	9	2346.3	0.1257	110	0.0016	15
	10	2357.4	0.1257	150	0.0016	15
EL	11	942.2	0.1251	100	0.0014	20
	12	921.7	0.1251	130	0.0014	20

	13	1971.2	0.1245	110	0.0007	20
	14	1859.6	0.1245	140	0.0007	20
BL	15	953.1	0.1240	100	0.0014	20
	16	897.9	0.1240	130	0.0014	20
	17	1422.8	0.1231	110	0.00105	15
	18	1895.0	0.1225	130	0.0007	20
	19	1849.3	0.1225	140	0.0007	20

3. RESULTS AND DISCUSSION

3.1 Kinetics

As described in several articles [19-21], hydrogenation of levulinic acid or its corresponding esters occurs in two reaction steps. The first step is the hydrogenation of the ketone group producing the following intermediates: 4-hydroxypentanoic acid (HPA) for LA, methyl 4-hydroxypentanoate (MHP) for ML, ethyl 4-hydroxypentanoate (EHP) for EL or butyl 4-hydroxypentanoate (BHP) for BL. The second step is the ring closure reaction of the intermediate to GVL. The mechanism of hydrogenation is illustrated in Fig. 3.

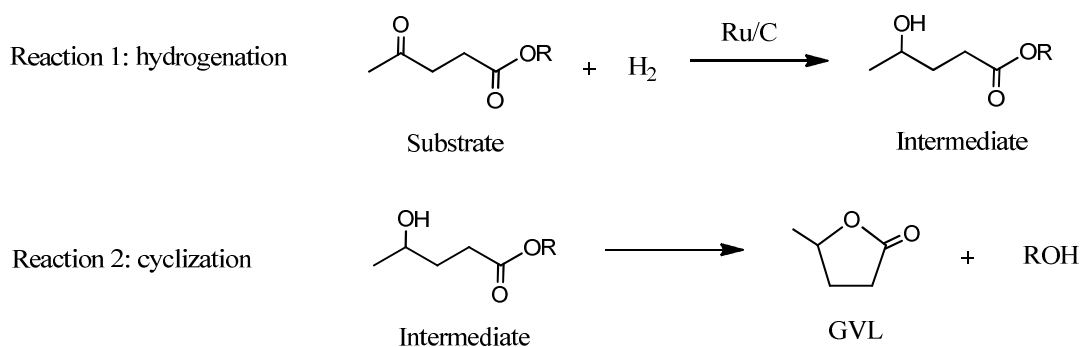

Fig. 3. Reaction mechanism for the hydrogenation of levulinic acid or its esters to γ -valerolactone.

The second reaction is often described as reversible for the case of hydrogenation in aqueous solvent [20, 35]. Based on our experimental observation, the reaction was found to be irreversible when using GVL as a solvent. As mentioned in the work of Piskun et al. [20], the second reaction was assumed to occur in the liquid bulk phase.

The rate of hydrogenation of LA/ML/EL/BL to HPA/MHP/EHP/BHP on the catalyst can be described as

$$R_1 = k_1 * [H_2]_{liq} * [Substrate]_{liq} * \omega_{cat}. \quad (1)$$

where, ω_{cat} . is the catalyst loading (kg.m^{-3}).

The rate equation for the second reaction (ring-closure) can be expressed as

$$R_2 = k_2 * [Intermediate] \quad (2)$$

The first reaction can be described by a more complex reaction mechanism such as Langmuir-Hinshelwood. Nevertheless, the description of such mechanism needs the adsorption coefficients that are cumbersome to estimate. In this study, we have deemed that the use of equations (1) and (2) can perfectly describe the kinetic rates.

The Taft equation is expressed as follows:

$$\log\left(\frac{k_i(T)}{k_{reference}(T)}\right) = \rho^* * \sigma_i^* + \delta * ES_i + \psi \quad (3)$$

where, the left side of the equation represents the ratio between the reaction rate of the substituted substrate with respect to the reference. On the right side of the Taft equation, there are three contributions. The first describes the polar effects of the substituent, multiplying the sensitivity factor of the reaction to polar effects (ρ^*) by the polar substituent constant (σ_i^*), which is a near-quantitative measure of the polar effect of the substituent. The second term describes the steric effects, multiplying the sensitivity factor of the reaction to steric effects (δ) by the steric substituent constant (ES_i), which is a near-quantitative measure of the steric effect of the substituent. The term ψ represents the resonance effect between the substituent and the reaction center. This term is equal to zero for the studied system because there is no resonance.

The Taft equation uses the substrate with the substituent methyl as the reference, that is the rate constant for the hydrogenation of methyl levulinate for the first reaction ($k_{1,ML}(T)$) and the rate

constant of methyl 4-hydroxypentanoate ring closure for the second reaction ($k_{2,MHP}(T)$). The term (T) was added to highlight the fact that these rate constants depend on the reaction temperature.

By introducing Taft equation in equations (1) and (2), we obtain:

$$R_{1,Subst.} = k_{1,ML}(T) * 10^{\rho_1^*(T)*\sigma_{Subst.}^* + \delta_1(T)*Es_{Subst.}} * [H_2]_{liq} * [Substrate]_{liq} * \omega_{Cat.} \quad (4)$$

$$R_{2,Int.} = k_{2,MHP}(T) * 10^{\rho_2^*(T)*\sigma_{Int.}^* + \delta_2(T)*Es_{Int.}} * [Intermediate]_{liq} \quad (5)$$

where, Subst. and Int. are the suffix for substrate and intermediate, respectively.

The values of σ_i^* and Es_i are available from literature [25] for each substituent as summarized in Table 2. The substrate and the corresponding intermediate have the same substituent, thus the same values of Taft parameters.

Table 2. Taft parameters for the reference (ML) and substituents (BL, EL, LA) [25].

Substrates & Intermediates	σ_i^*	Es_i
BL & BHP	-0.13	-0.39
EL & EHP	-0.1	-0.07
LA & HPA	0.49	1.24
ML & MHP	0	0

From a previous study of our group [25], we have noticed that Taft parameters $\rho^*(T)$ and $\delta(T)$ are temperature dependent. For that reason, the term (T) was added for these parameters. In this study, a linear relationship between $\rho^*(T)$ and $\delta(T)$ and the reaction temperature was assumed. Therefore, one can describe them by the following equations:

$$\rho_1^*(T) = A_1 + B_1 * T(K) \quad (6)$$

$$\delta_1(T) = C_1 + D_1 * T(K) \quad (7)$$

$$\rho_2^*(T) = A_2 + B_2 * T(K) \quad (8)$$

$$\delta_2(T) = C_2 + D_2 * T(K) \quad (9)$$

During the modeling stage, the rate constants $k_{1,ML}(T)$ and $k_{2,MHP}(T)$, and the parameters $A_1, B_1, C_1, D_1, A_2, B_2, C_2$ and D_2 were estimated.

3.2 Mass balance

Experiments were performed under isobaric and isothermal conditions.

Mass balance in the liquid phase

Mass balance for the different compounds present in the liquid phase can be expressed as:

$$\frac{dC_{Substrate}}{dt} = -R_1 \quad (10)$$

$$\frac{d[H_2]_{liq}}{dt} = k_L \cdot a * ([H_2]_{liq}^* - [H_2]_{liq}) - R_1 \quad (11)$$

$$\frac{dC_{Intermediate}}{dt} = R_1 - R_2 \quad (12)$$

$$\frac{dC_{ROH}}{dt} = R_2 \quad (13)$$

$$\frac{dC_{GVL}}{dt} = R_2 \quad (14)$$

where, $[H_2]_{liq}^*$ is the concentration of hydrogen at the gas-liquid interface, that was determined using Henry's constant $He(T) = \frac{[H_2]_{liq}^*}{P_{H_2, Reactor}}$ (mol.m⁻³.bar⁻¹), $k_L \cdot a$ is the volumetric gas to liquid mass transfer coefficient for hydrogen (s⁻¹). The detailed description of the mass transfer study is given in the following paragraph.

3.3 Mass transfer study

This is a gas-liquid-solid reaction system, thus, mass transfer plays an important role. A two-film theory was used to describe the mass transfer of hydrogen from the gas to the liquid phase [26-29]. The resistance from the gas side was neglected.

The effect of external mass transfer (from the bulk of the liquid phase to the surface of the solid catalyst) was experimentally verified for levulinic acid and butyl levulinate hydrogenation by varying the stirring rate. It was found that the external mass transfer resistance can be neglected above 1000 rpm (see Supplementary Material).

The effect of internal mass transfer (diffusion in the pores of the solid catalyst) was evaluated by using the Weisz-Prater criterion as used in Piskun et al. [20]. It was found that internal mass transfer can be assumed to be negligible because this criterion was found to be lower than 0.01.

In order to have an accurate description of gas to liquid mass transfer for hydrogen, an expression for the volumetric mass transfer coefficient for hydrogen $k_L \cdot a$ taking into account the temperature, viscosity and density of the system was developed [29, 31]. Due to the low concentration of the different substrates (< 20 % by weight), the evaluation was done considering pure GVL.

Kawase and Moo-Yong [32] have demonstrated that the mass transfer coefficient in an aerated tank reactor can be expressed as:

$$k_L = \frac{2}{\sqrt{\pi}} * \sqrt{D_{H_2/Liq}} * \xi^{0.25} * \left(\frac{\rho_{Liq}}{\mu_{Liq}}\right)^{0.25} \quad (15)$$

where $D_{H_2/Liq}$ is the coefficient for the diffusion of hydrogen in the liquid phase ($m^2 \cdot s^{-1}$), k_L is the gas-liquid mass transfer coefficient of hydrogen from liquid side ($m \cdot s^{-1}$), ξ is the energy dissipation rate per unit mass ($W \cdot kg^{-1}$), ρ_{Liq} is the density of the liquid ($kg \cdot m^{-3}$) and μ_{Liq} is the dynamic viscosity (Pa.s).

The diffusion coefficient $D_{H_2/Liq}$ can be expressed by the correlation of Wilke-Chang [33]:

$$D_{H_2/Liq} = \frac{7.4 * 10^{-8} * (\phi * M_{Liq})^{\frac{1}{2}} * T_{Liq}}{\mu_{Liq} * V_{H_2}^{0.6}} \quad (16)$$

where, ϕ is the association factor (-), M_{Liq} is the molar mass of the solvent ($g \cdot mol^{-1}$), T_{Liq} is the temperature of the liquid phase (K), μ_{Liq} is the viscosity (cP) and V_{H_2} is the normal molar volume of hydrogen equal to $14.3 \text{ (cm}^3 \cdot mol^{-1}\text{)}$.

By combining equations (15) and (16), we obtain:

$$k_L \cdot a = (k_L \cdot a)_{modified} * \left(\frac{T_{Liq}}{\mu_{Liq}}\right)^{0.5} * \left(\frac{\rho_{Liq}}{\mu_{Liq}}\right)^{0.25} \quad (17)$$

where $(k_L \cdot a)_{modified} = \frac{2}{\sqrt{\pi}} * \sqrt{\frac{7.4 * 10^{-8} * (\phi * M_{Liq})^{0.5}}{V_{H_2}^{0.6}}} * \xi^{0.25}$ was assumed constant for all the experiments, considering GVL as the main chemical compound. The temperature dependence of the density and kinematic viscosity of GVL was measured, and the results are shown in the next paragraph.

To estimate the mass transfer coefficient $(k_L \cdot a)_{modified}$, different experiments with only GVL solution were performed in the absence of chemical reactions. It was assumed that the number of

moles disappearing in the reservoir corresponds to the number of moles of hydrogen in the liquid phase. Ideal gas law was used to determine the number of moles based on the pressure. ODE (11) was solved in the absence of chemical reactions, i.e., $R_1=R_2= 0 \text{ mol.m}^{-3}.\text{s}^{-1}$.

Finally, in order to determine Henry's constant as a function of temperature, mass transfer experiments were carried out at four different temperatures for a long period, in order to reach the thermodynamic equilibrium. Van't Hoff equation was used to express Henry's temperature's dependence:

$$He(T_R) = He(T_{Ref} = 373.15K) * \exp\left(\frac{-\Delta H_{Sol}}{R} * \left(\frac{1}{T_R} - \frac{1}{373.15}\right)\right) \quad (18)$$

For the mass transfer study, the number of moles of hydrogen in the liquid phase was used as an observable. The objective function was defined according to Equation (21) and solved as described in paragraph 3.5 (Modeling).

3.4 Physicochemical properties

The same methodology developed by our group [34] was used to measure the evolution of density and kinematic viscosity of GVL with temperature.

Density (kg.m^{-3}) varies with temperature T (K) as

$$\rho = a' + b' * T \quad (19)$$

Viscosity follows an Arrhenius law:

$$\mu = A \times e^{\frac{-E_a}{R*T}} \quad (20)$$

where, μ is the dynamic viscosity (Pa.s), A is the pre-exponential factor, Ea is the activation energy ($\text{J}\cdot\text{mol}^{-1}$), R is the universal gas constant ($\text{J}\cdot\text{K}^{-1}\cdot\text{mol}^{-1}$) and T is temperature (K).

Fig. 4 shows the evolution of the measured density versus temperature, as per Equation (19). Fig. 5 shows that viscosity follows Equation (20).

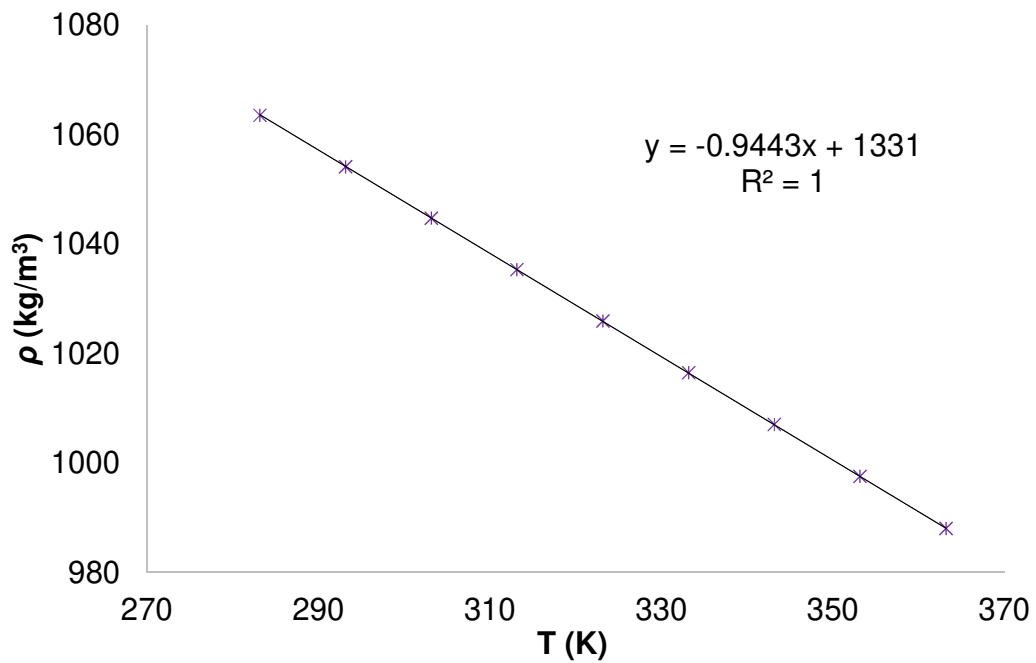

Fig. 4. Evolution of GVL density with temperature.

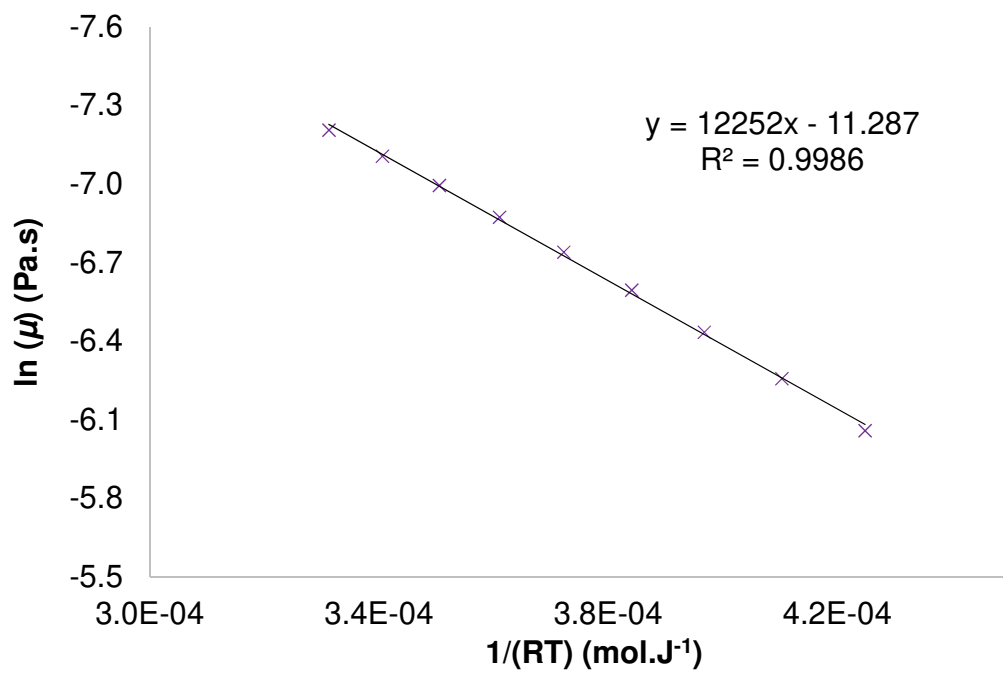

Fig. 5. Arrhenius curve for GVL viscosity.

3.5 Modeling

For the modeling stage, the software ModEst [30] was used. Ordinary differential equations were solved using ODESSA algorithm.

For the parameter estimation, the concentrations of substrate, intermediate and GVL were used as observable variables. The objective function was defined as:

$$\omega = \sum_i (y_i - \hat{y}_i)^2 \quad (21)$$

where, y_i is the experimental value and \hat{y}_i is the simulated one.

The objective function was minimized by Simplex algorithm, then by Levenberg-Marquardt algorithm.

From the mass transfer experiments, it was found that $\Delta H_{Sol.H_2} = 5936.8 \text{ J.mol}^{-1}$ and $He(T_{Ref} = 373.15K) = 1.86 \text{ mol.m}^{-3}.\text{bar}^{-1}$ as illustrated in Fig. 6. Compared to the hydrogenation of levulinic acid in water [35], the absorption of hydrogen in GVL is an endothermic phenomenon. This endothermic behavior was also observed for other organic solvents [36-38]. This can be beneficial because, as the reaction temperature increases, the solubility of hydrogen and the kinetics of hydrogenation increase.

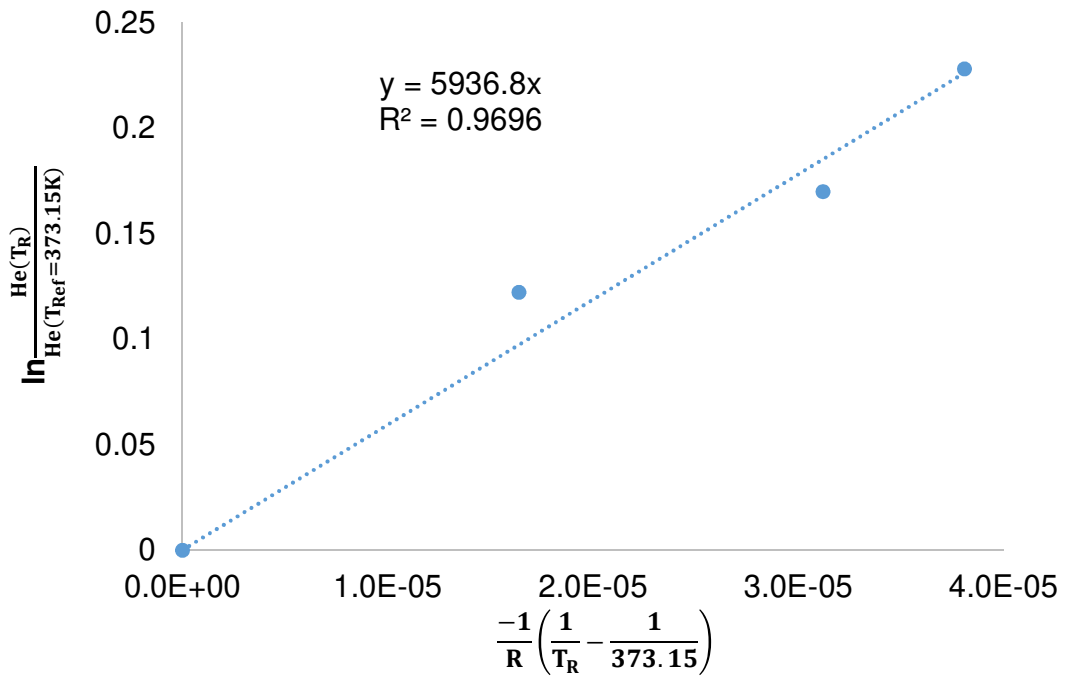

Fig. 6. Van't Hoff plot for the absorption of hydrogen in GVL.

For mass transfer modeling, the coefficient of explanation, defined as $R^2 = 1 - \left(\frac{y_i - \hat{y}_i}{y_i - \bar{y}_i} \right)^2$, was found to be 95% showing the reliability of the fitting to the experimental data. Table 3 shows the estimated values of mass transfer. Fig. 7 shows the fitting of the model to the experimental data. In general, one can say that the model fits well the experimental data.

Table 3. Results of the mass transfer constant.

PARAMETERS	UNITS	VALUE	Std error (%)
$(k_L \cdot a)_{modified}$	$\left(\frac{\text{Pa} \cdot \text{s}}{\text{K}} \right)^{0.5} \cdot \left(\frac{\text{Pa} \cdot \text{s}}{\text{kg} \cdot \text{m}^{-3}} \right)^{0.25} \cdot \text{s}^{-1}$	$2.22 \cdot 10^{-6}$	2.4

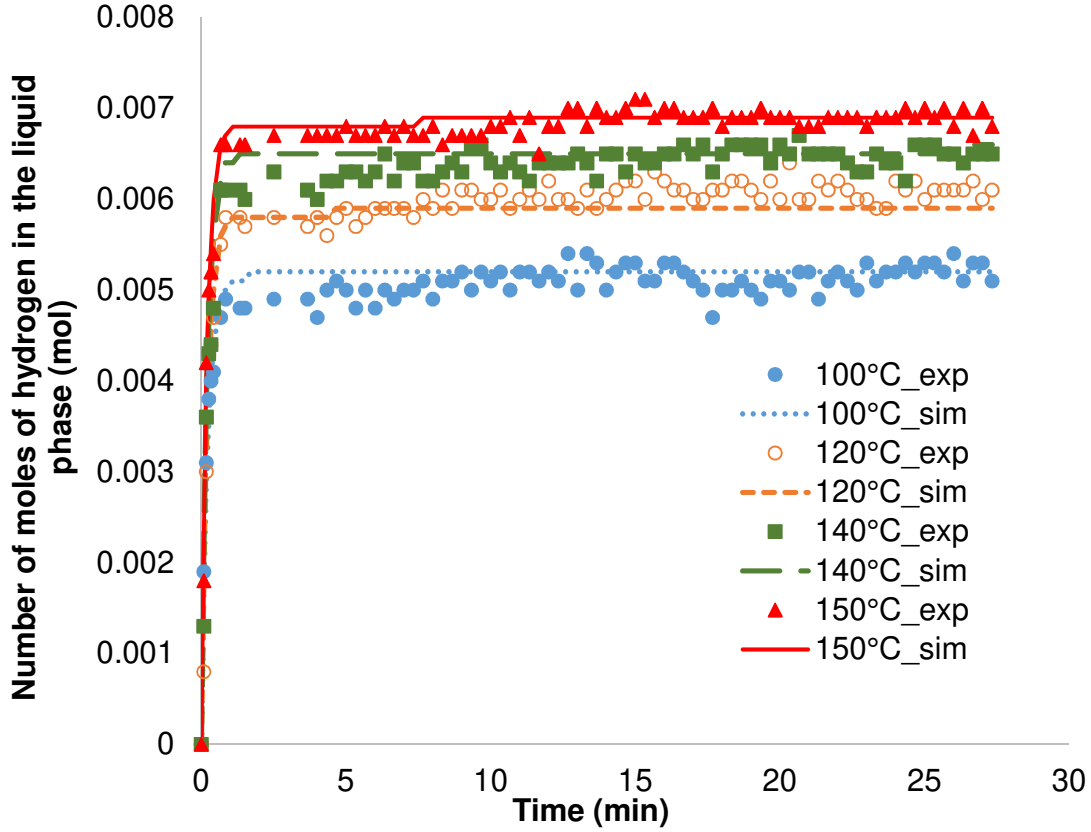

Fig. 7. Fit of the model to the mass transfer experiments under a pressure of ca. 20 bars.

For the kinetic modeling, the value of $(k_L \cdot a)_{modified}$ estimated previously was used. Rate constants of reactions 1 and 2 for the hydrogenation of ML were expressed by using modified Arrhenius equation:

$$k_i(T_R) = k_i(T_{Ref}) * \exp\left(\frac{-Ea_i}{R} * \left(\frac{1}{T_R} - \frac{1}{T_{Ref}}\right)\right) \quad (22)$$

ODEs (10)-(14) were solved. Concentrations of substrate, intermediate and GVL were used as observables for the non-linear regression stage. The following parameters were estimated: constants $k_{1,ML}(T_{Ref})$, $Ea_{1,ML}$, $k_{2,MHP}(T_{Ref})$, $Ea_{2,MHP}$ and the parameters A_1 , B_1 , C_1 , D_1 , A_2 , B_2 , C_2 and D_2 .

For the kinetic modeling, the coefficient of explanation was found to be equal to 99.82%, showing the good fitting of the model to the experimental data. Table 4 displays the estimated parameters and the standard deviations.

Table 4. Estimated parameters and standard deviation at $T_{Ref}= 403.15K$

	Units	Estimated Parameters	Estimated Relative Standard Error (%)
$k_{1,ML}(T_{Ref})$	$m^6.mol^{-1}.kg^{-1}.s^{-1}$	3.79E-06	4.6
$Ea_{1,ML}$	$J.mol^{-1}$	15000.00	21.8
$k_{2,MHP}(T_{Ref})$	s^{-1}	8.92E-04	7
$Ea_{2,MHP}$	$J.mol^{-1}$	59300.00	6.4
A1	-	25.00	54.2
B1	K^{-1}	-0.07	51.5
C1	-	-10.00	54.6
D1	K^{-1}	0.03	51.3
A2	-	-22.00	50.4
B2	K^{-1}	0.06	46.7
C2	-	-8.40	49.2
D2	K^{-1}	0.02	44.9

Table 4 shows that standard deviation for kinetic constants are low. Nevertheless, the standard deviation for the Taft parameters are not low. This could be explained by the fact that equations (6)-(9) might not be the most appropriate to represent the evolution of ρ^* and δ with temperature.

Fig. 8 shows some fitting of the model to the experimental data. In general, the fitting is correct. One can observe that the fitting of the model to the intermediate concentration is less accurate. This is due to the high reactivity of these species making their analysis less accurate, which is particularly pronounced for the intermediate 4-hydroxypentanoic acid. The fitting of the model to the experimental concentration of 4-hydroxypentanoic acid is lower compared to the other ones due to its higher reactivity. The parity plot (Fig. 9) shows that the developed model is reliable. The parity plot (Fig. 9) shows that the developed model is reliable.

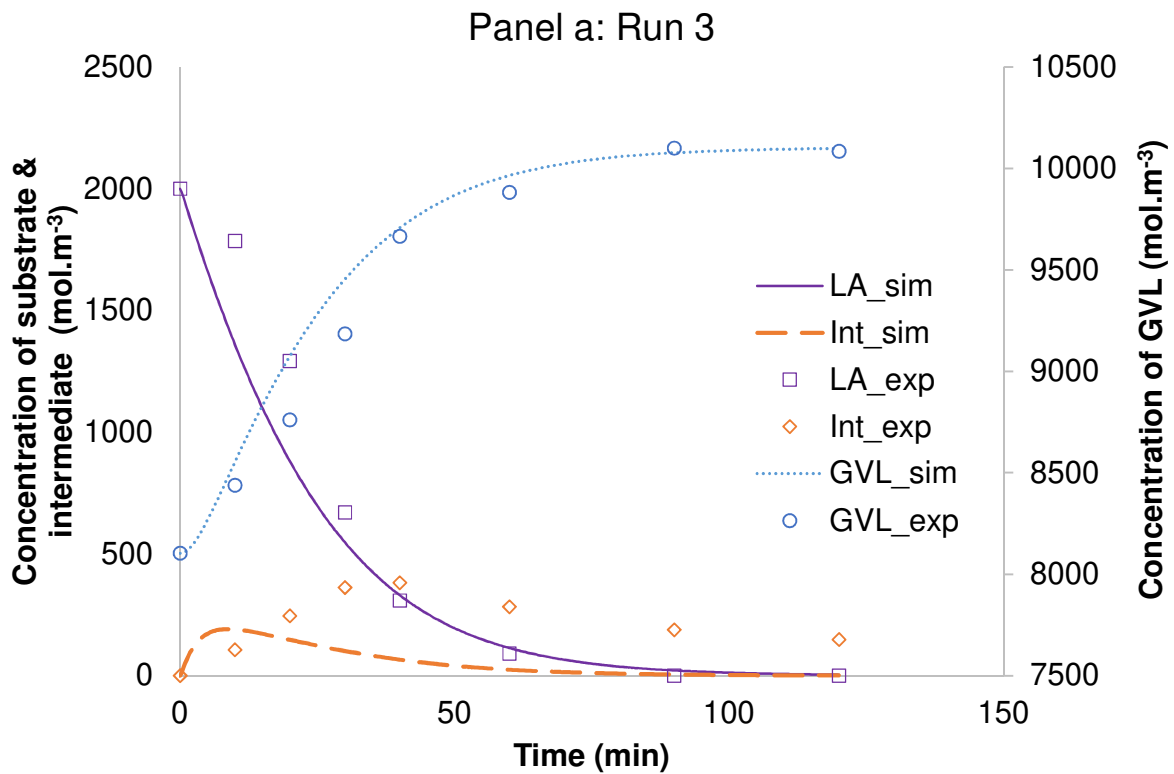

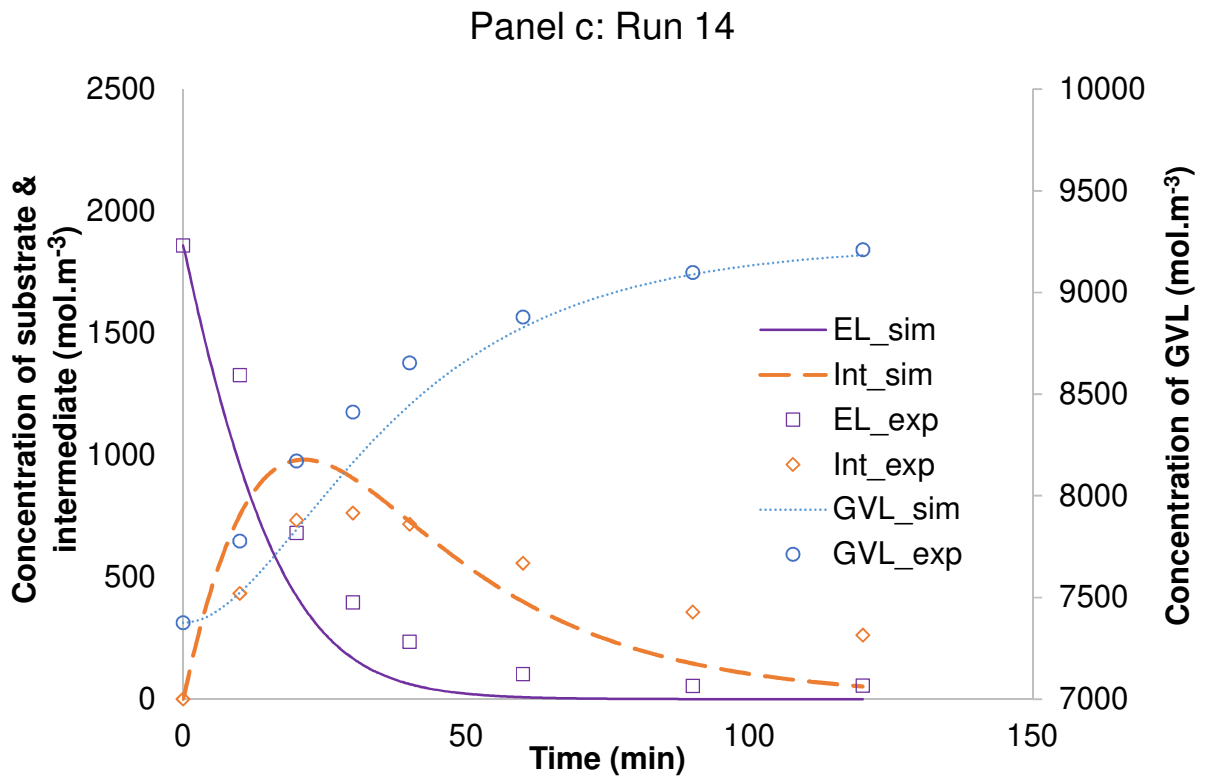
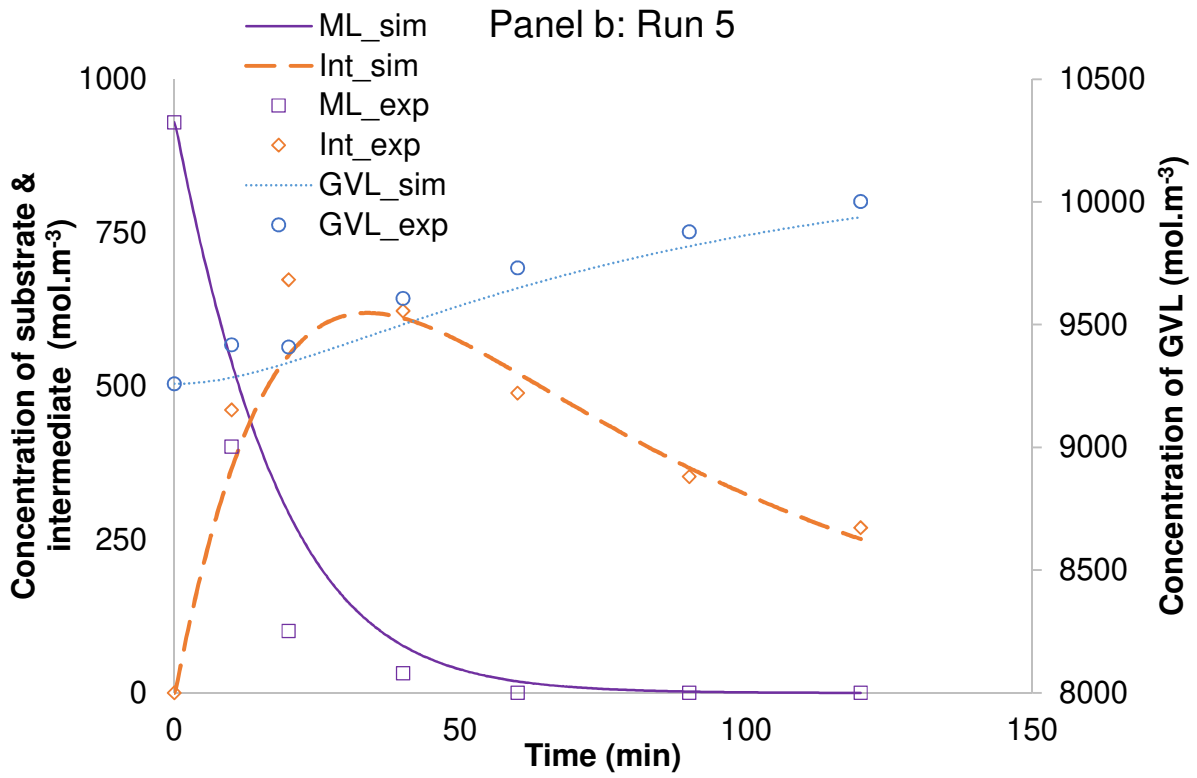

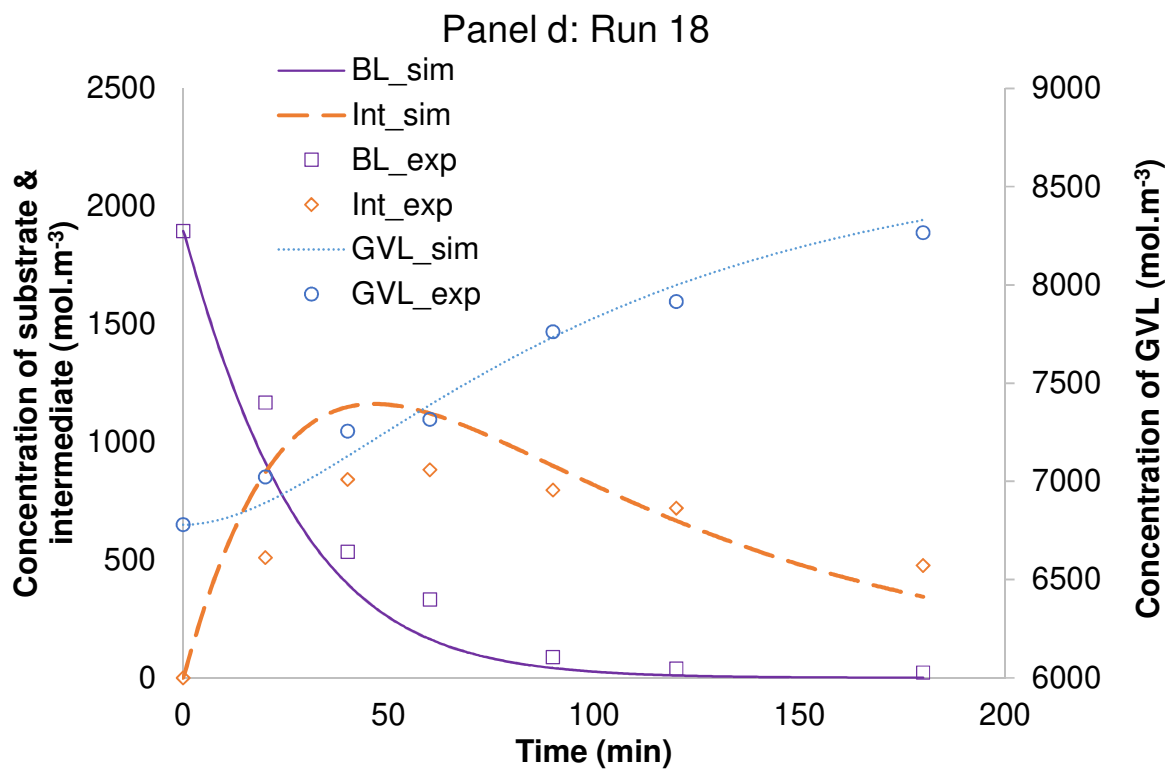

Fig. 8. Fitting of the model to the experimental data for the different substrates: LA (panel a), ML (panel b), EL (panel c) and BL (panel d).

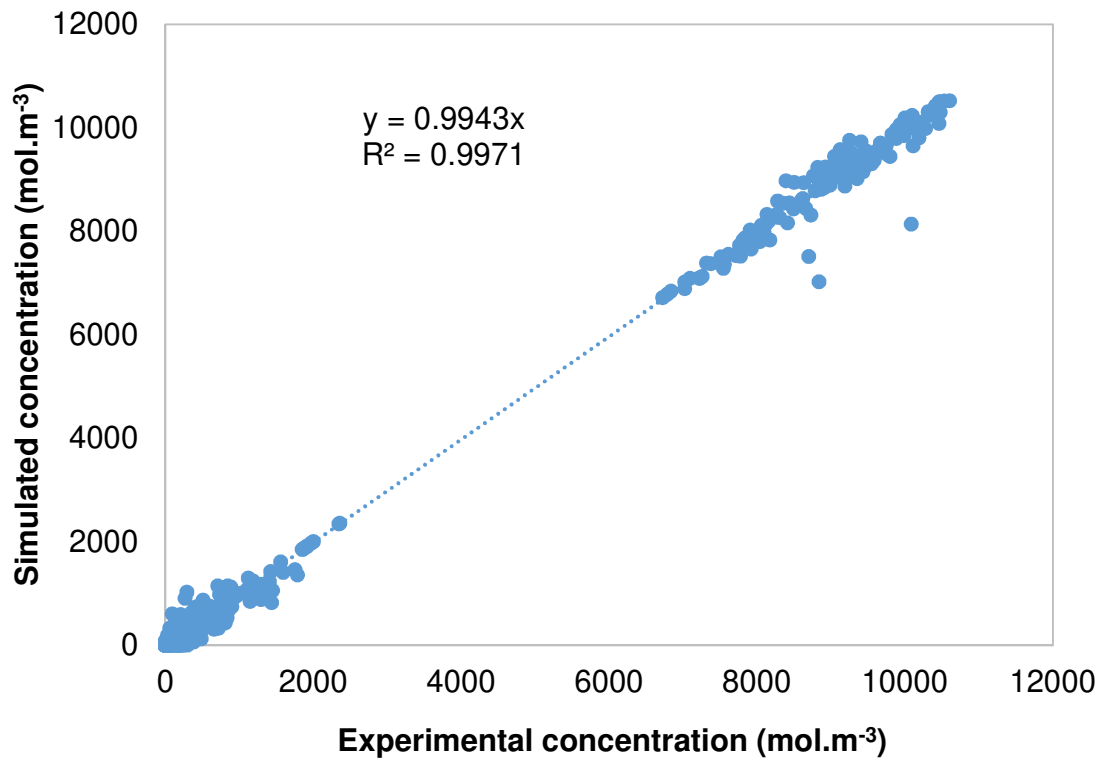

Fig. 9. Parity plot.

Based on Table 4, it is possible to determine the kinetic constants for the different substrates (Table 5).

Table 5. Kinetic constants for the hydrogenation of LA, ML, EL and BL ($T_{Ref} = 403.15K$)

		ML	EL	BL	LA
$k_{1,Subst.}(T_{Ref})$	$m^6.mol^{-1}.kg^{-1}.s^{-1}$	3.79E-06	5.17E-06	3.09E-06	5.13E-06
$Ea_{1,Subst.}$	$J.mol^{-1}$	15000	28931	9680	17029
$k_{2,Int.}(T_{Ref})$	s^{-1}	8.92E-04	4.45E-04	1.88E-04	1.92E-01
$Ea_{2,Int.}$	$J.mol^{-1}$	59300	37056	10250	228693

From Table 5, it is possible to notice that the rate constants of hydrogenation of substrates in GVL are not proportional to the steric hindrance of the alkyl groups.

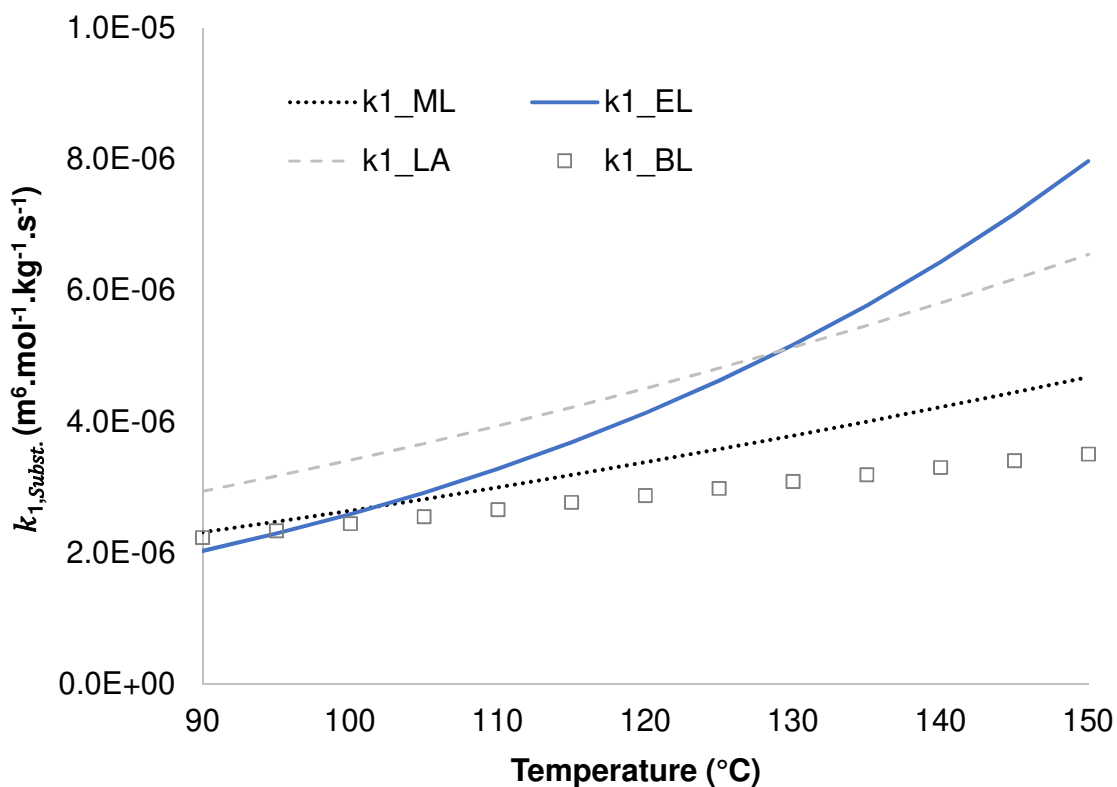

Fig. 10. Evolution of rate constants 1 for different substrates with temperature.

From Fig. 10, we can notice that rate constants of hydrogenation of LA, EL, ML and BL are affected by the nature of the substituent and the temperature. This observation could be surprising because the substituent is relatively far from the ketone group. For reaction temperature lower than 135°C, the rate constant for the hydrogenation of levulinic acid is the highest one. Whereas, for reaction temperature higher than 135°C, the rate constants increase in the following order: $k_{1,EL} > k_{1,LA} > k_{1,ML} > k_{1,BL}$. This difference of reactivity is not in agreement with the steric hindrance induced by the substituent.

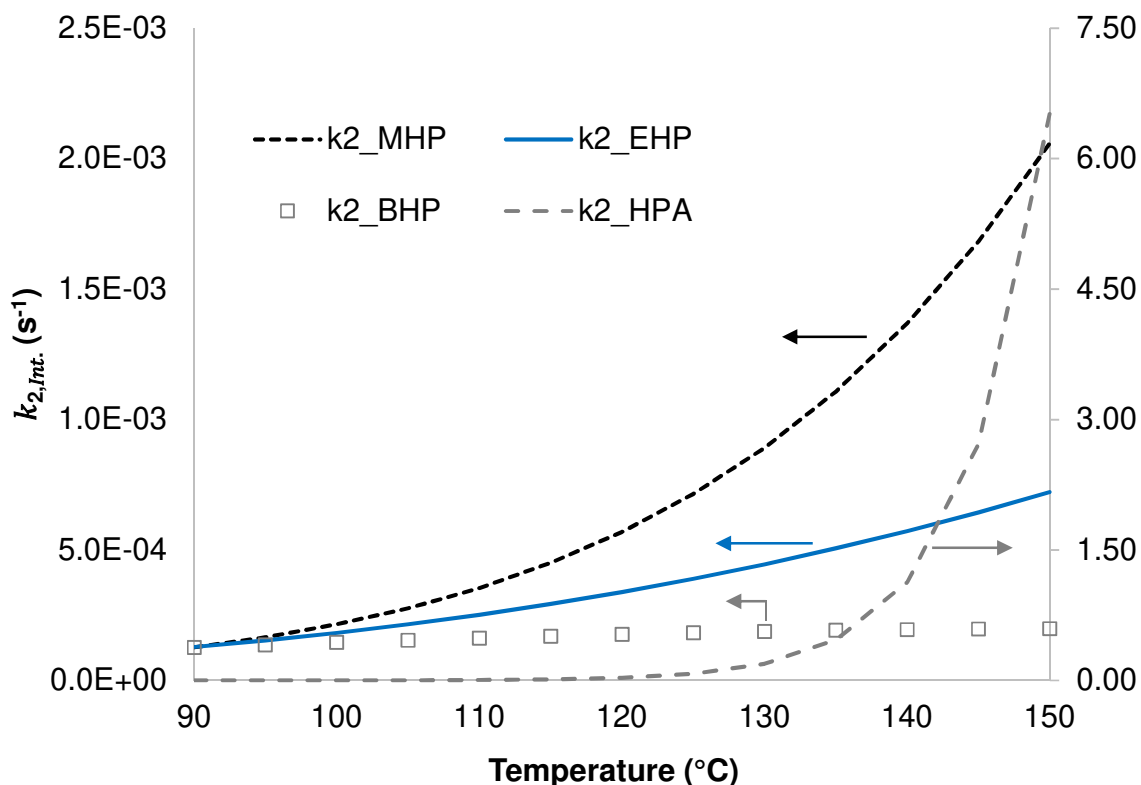

Fig. 11. Evolution of rate constants 2 for different substrates with temperature.

From Fig. 11, the influence of the substituent groups and temperature is more significant on rate constant 2 than for rate constant 1. This observation seems to be logical because the substituents are closer to the reaction center. In the temperature range 90-150°C, the rate constants increase in the following order: $k_{2,HPA} \gg k_{2,MHP} > k_{2,EHP} > k_{2,BHP}$. When the steric hindrance is lower, then the reaction rate is faster.

From Figs. 10 and 11, it is possible to notice that steric hindrance could not explain properly the kinetic behavior of the hydrogenation of LA, ML, EL and BL.

Fig. 12 shows the evolution of the Taft parameters (ρ_1^* , ρ_2^* , δ_1 and δ_2) with temperature. The influence of the polar effect (ρ_1^* and ρ_2^*) on both reactions is higher than the steric effect, and this difference is more pronounced when the reaction temperature is higher than 110°C.

Steric effect can be considered as negligible for reaction temperature lower than 140°C for both reactions, i.e., δ_1 and δ_2 are lower than 1.

Furthermore, polar effect of reaction 1 starts to be significant when reaction temperature is ca. 115°C and 110°C for reaction 2. For reaction 1, the value of ρ_1^* is negative. From Taft definition, this means that the reaction is accelerated by electron donating group. As the temperature increases, the ethyl group increases the most the electron donor capacity of the group ROOC-CH₂-CH₂- on the ketone group. For reaction 2, the value of ρ_2^* is positive. From Taft definition, this means that the reaction is accelerated by electron withdrawing group. From the four substrates, the hydrogen group is the most electron withdrawing group explaining the fact that reaction 2 with hydrogen substituent is the fastest one.

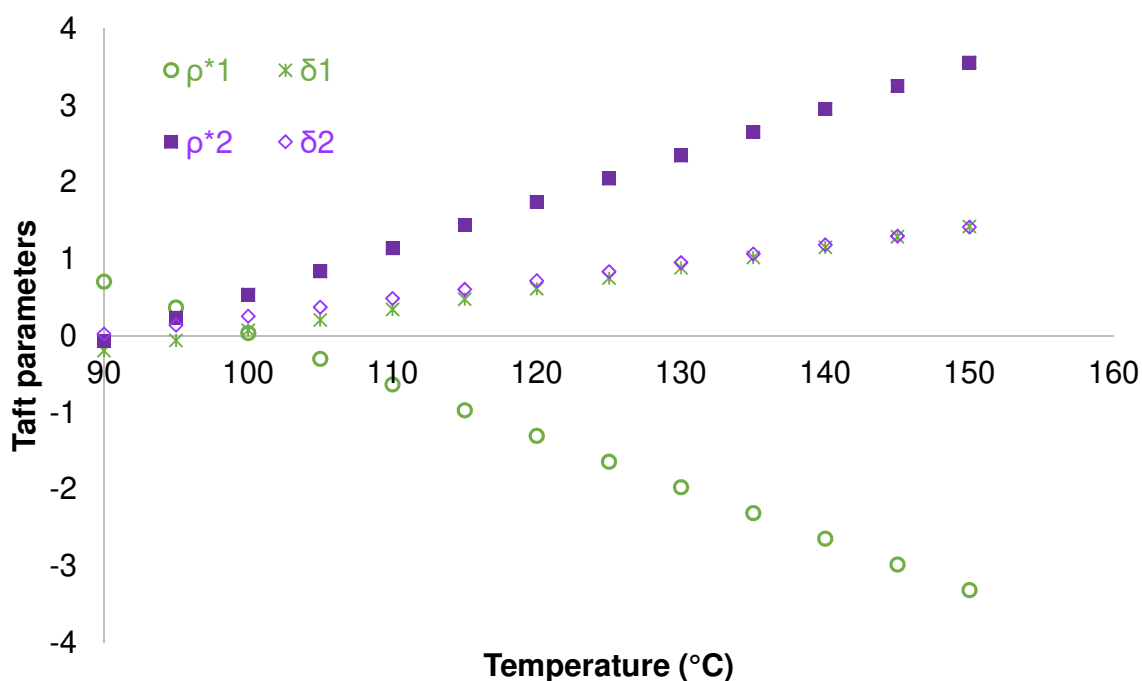

Fig. 12. Influence of temperature on Taft parameters.

From the estimated kinetic constants, it is possible to plot the kinetics of GVL production under the same operating conditions for LA, ML, EL and BL at two temperatures (Figs. 13 and 14).

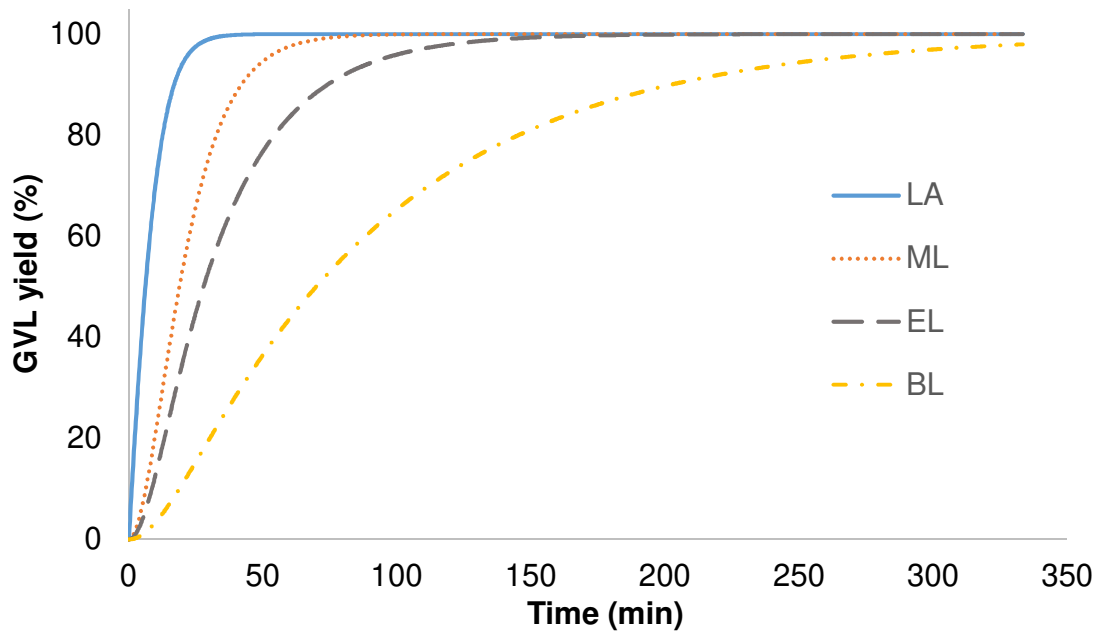

Fig. 13. Kinetics of production of GVL from LA, ML, EL and BL at 140°C and 20 bar of H₂:

$$[Substrate]_{initial} = 1000 \text{ mol.m}^{-3}, [GVL]_{initial} = 7685 - 8250 \text{ mol.m}^{-3} \text{ and } \omega_{Cat.} = 11.67 \text{ kg.m}^{-3}.$$

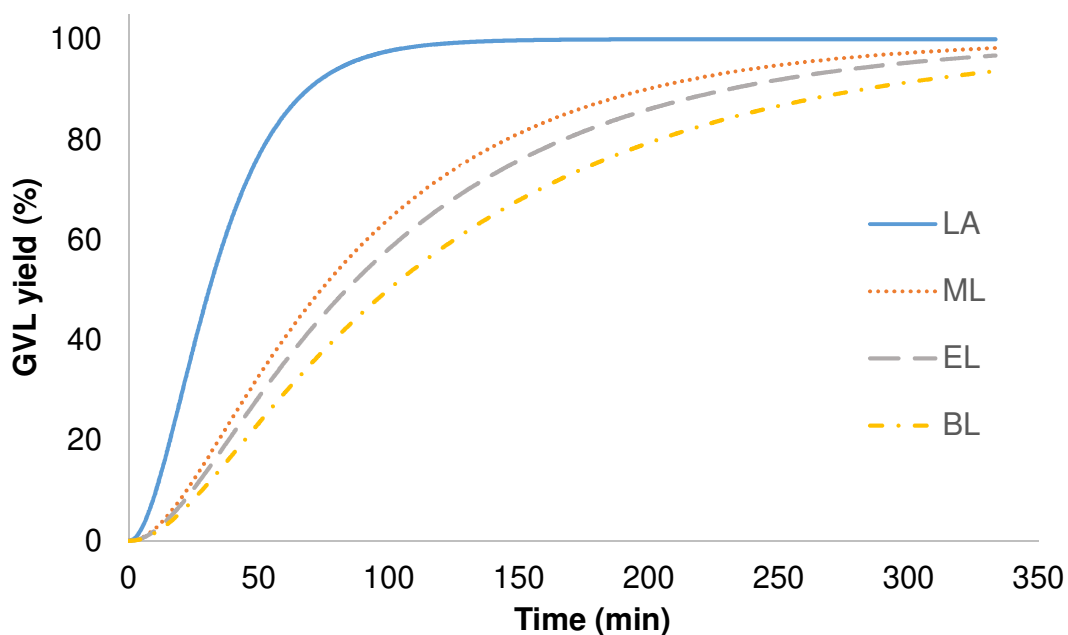

Fig. 14. Kinetics of production of GVL from LA, ML, EL and BL at 100°C and 20 bar of H₂:

$$[Substrate]_{initial} = 1000 \text{ mol.m}^{-3}, [GVL]_{initial} = 8064 - 8625 \text{ mol.m}^{-3} \text{ and } \omega_{Cat.} = 11.67 \text{ kg.m}^{-3}.$$

From Figs 13 and 14, one can notice that the rates of GVL production increases in the following order: $r_{GVL \text{ from LA}} > r_{GVL \text{ from ML}} > r_{GVL \text{ from EL}} > r_{GVL \text{ from BL}}$. Reaction rate 2 is the governing reaction for ML, EL and BL which is not the case for LA (Figs. 15 and 16). From Figs. 15 and 16, one can notice that reaction rates 1 are faster than reaction rates 2 for the hydrogenation of alkyl levulinate, but for the hydrogenation of LA both reaction rates are similar.

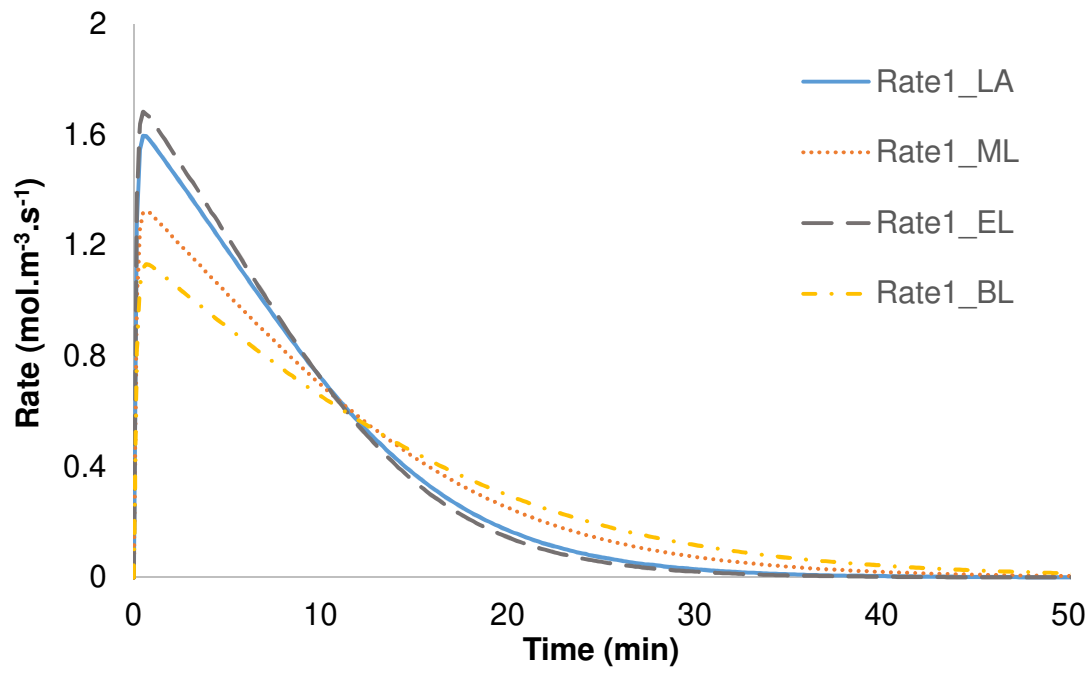

Fig. 15. Reaction rate 1 at 140°C and 20 bar of H₂: $[Substrate]_{initial} = 1000 \text{ mol.m}^{-3}$,
 $[GVL]_{initial} = 7685 - 8250 \text{ mol.m}^{-3}$ and $\omega_{cat.} = 11.67 \text{ kg.m}^{-3}$.

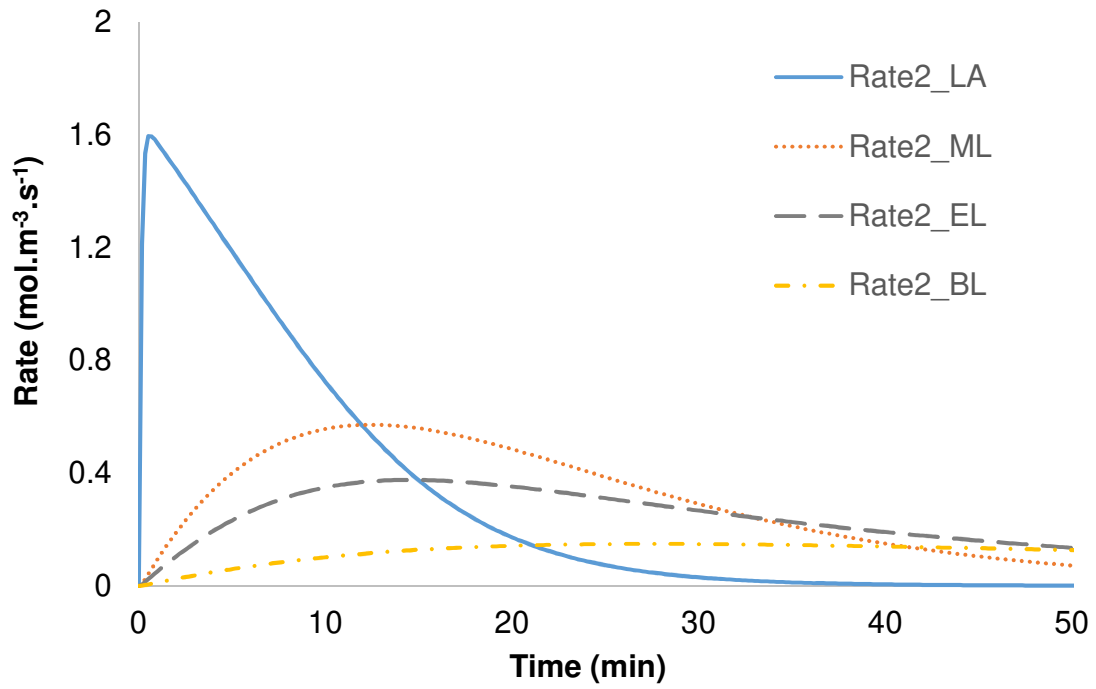

Fig. 16. Reaction rate 2 at 140°C and 20 bar of H₂: $[Substrate]_{initial} = 1000 \text{ mol.m}^{-3}$,
 $[GVL]_{initial} = 7685 - 8250 \text{ mol.m}^{-3}$ and $\omega_{cat.} = 11.67 \text{ kg.m}^{-3}$.

4. Conclusion

Hydrogenation of levulinic acid and methyl, ethyl, butyl esters using Ru/C as catalyst to γ -valerolactone (GVL) was studied. Experiments were performed at isobaric and isothermal conditions and GVL was used as solvent to avoid liquid-liquid reaction system.

A mass transfer investigation was done to evaluate the mass transfer coefficient ($k_L \cdot a$) for the transfer of hydrogen from the gas to the liquid phase. The influence of reaction temperature, solvent viscosity and density was taken into account to determine the value of $k_L \cdot a$. Besides, it was found that Henry's constant for hydrogen absorption in GVL follows a van't Hoff law. This absorption was found to be endothermic meaning that temperature increase leads to increase the amount of absorbed hydrogen.

A kinetic model, including mass transfer parameters, was developed by varying the reactant concentration, hydrogen pressure, reaction temperature and catalyst loading. The originality of this model was the use of Taft equation to take into account the steric and polar effects of the substituents (H-, CH₃-, CH₃-CH₂-, CH₃-CH₂-CH₂-CH₂-) for the hydrogenation and ring-closure step reactions. We have demonstrated that the Taft parameters $\rho^*(T)$ and $\delta(T)$ vary with temperature. It was found that $r_{\text{GVL from LA}} > r_{\text{GVL from ML}} > r_{\text{GVL from EL}} > r_{\text{GVL from BL}}$.

For this reaction system, the steric effect was found to be negligible for both reactions. Nevertheless, the polar effects were found to be important for the ring-closure ones. The rate of GVL production is faster by using LA, because the electron withdrawing effect of the group H- increases the kinetics of reaction 2. The reaction 2 is slower for the hydrogenation for the other alkyl because alkyl groups are electron-donating groups.

This study opens new possibility in chemical reaction engineering, by knowing the Taft parameters, it is possible to predict the rate constants with other substrates. The continuation of this work is to

test the Taft equation on other substrates and have a better understanding on the evolution of Taft parameters with temperature.

Notation

D_j	molecular diffusion coefficient of j [$\text{m}^2 \cdot \text{s}^{-1}$]
E_{a_i}	activation energy of reaction i [$\text{J} \cdot \text{mol}^{-1}$]
E_{s_i}	near-quantitative measure of the steric effect of a substituent i
H_e	Henry's coefficient [$\text{mol} \cdot \text{m}^{-3} \cdot \text{bar}^{-1}$]
ΔH_{sol}	dissolution enthalpy [$\text{J} \cdot \text{mol}^{-1}$]
k_i	Rate constant of reaction i
$k_{L,a}$	volumetric mass transfer coefficient [s^{-1}]
$(k_{L,a})_{\text{modified}}$	modified volumetric mass transfer coefficient [$(\frac{\text{Pa} \cdot \text{s}}{\text{K}})^{0.5} \cdot (\frac{\text{Pa} \cdot \text{s}}{\text{kg} \cdot \text{m}^{-3}})^{0.25} \cdot \text{s}^{-1}$]
r_j	rate of formation or disappearance of compound j [$\text{mol} \cdot \text{m}^{-3} \cdot \text{s}^{-1}$]
P	pressure [bar]
R_i	reaction rate i [$\text{mol} \cdot \text{m}^{-3} \cdot \text{s}^{-1}$]
R	gas constant [$\text{J} \cdot \text{K}^{-1} \cdot \text{mol}^{-1}$]
R^2	coefficient of explanation [%]
T	temperature [K]
V_{molar}	molar volume [$\text{cm}^3 \cdot \text{mol}^{-1}$]
w_i	weight percent
y_i	experimental observable
\bar{y}	mean value of the experimental observables
\hat{y}_i	observable simulated by the model

Greek letters

δ	sensitivity factor of a reaction series to steric effects
μ	liquid viscosity [Pa.s]
σ_i^*	near-quantitative measure of the polar effect of a substituent i
ξ	energy dissipation rate per unit mass [W.kg ⁻¹]
ρ	mass density [kg.m ⁻³]
ρ^*	sensitivity factor of a reaction series to polar effects
ψ	resonance effect between the substituent & the reaction center
ω	objective function
$\omega_{cat.}$	catalyst loading [kg.m ⁻³]
ϕ	association factor

Subscripts and superscripts

ave	average
Ref	reference
*	interfacial value

Abbreviations

BL	butyl levulinate
BHP	butyl 4-hydroxypentanoate
EL	ethyl levulinate

EHP	ethyl 4-hydroxypentanoate
HPA	4-hydroxypentanoic acid
LA	levulinic acid
ML	methyl levulinate
MHP	methyl 4-hydroxypentanoate
GVL	γ -valerolactone
ROH	co-product of the second reaction (water, methanol, ethanol or butanol)

Acknowledgments

This study has been done in the framework of Task 2: “Green process: 2nd generation of biomass” of AMED project. The authors thank the AMED project. The AMED project has been funded with the support from the European Union with the European Regional Development Fund (ERDF) and from the Regional Council of Normandie. The China Scholarship Council: Cooperation Program with the UTs and INSAs (France) is thanked by the authors. The authors thank the *Maîtrise des Risques et Environnementaux department*, and the Erasmus programme to make the research project of Mariasole Cipolletta possible.

References

- [1] The Mexican tortilla crisis of 2007: the impacts of grain-price increases on food-production chains Alder Keleman & Hugo García Rañó <https://doi.org/10.1080/09614524.2011.562487>
- [2] V. Casson Moreno, A.L. Garbetti, S. Leveneur, G. Antonioni, A consequences-based approach for the selection of relevant accident scenarios in emerging technologies, *Safety Science*. 112 (2019) 142–151. doi:10.1016/j.ssci.2018.10.024.
- [3] L. Yan, Q. Yao, Y. Fu, Conversion of levulinic acid and alkyl levulinates into biofuels and high-value chemicals, *Green Chem.* 19 (2017) 5527–5547. doi:10.1039/C7GC02503C.
- [4] B.T. Huang, S. Leveneur, T. Zamar, J.P. Mikkola, B. Taouk, Towards Production of γ -valerolactone via Hydrogenation of Aqueous Levulinic Acid, *International Journal of Chemical Reactor Engineering*. 13 (2015) 119–127. doi:10.1515/ijcre-2014-0077.
- [5] F.M.A. Geilen, B. Engendahl, A. Harwardt, W. Marquardt, J. Klankermayer, W. Leitner, Selective and Flexible Transformation of Biomass-Derived Platform Chemicals by a Multifunctional Catalytic System, *Angewandte Chemie International Edition*. 49 (2010) 5510–5514. doi:10.1002/anie.201002060.
- [6] J.M. Tukacs, D. Király, A. Strádi, G. Novodarszki, Z. Eke, G. Dibó, T. Kégl, L.T. Mika, Efficient catalytic hydrogenation of levulinic acid: a key step in biomass conversion, *Green Chem.* 14 (2012) 2057–2065. doi:10.1039/C2GC35503E.
- [7] J.M. Tukacs, M. Novák, G. Dibó, L.T. Mika, An improved catalytic system for the reduction of levulinic acid to γ -valerolactone, *Catal. Sci. Technol.* 4 (2014) 2908–2912. doi:10.1039/C4CY00719K.

- [8] J.M. Tukacs, B. Fridrich, G. Dibó, E. Székely, L.T. Mika, Direct asymmetric reduction of levulinic acid to gamma-valerolactone: synthesis of a chiral platform molecule, *Green Chem.* 17 (2015) 5189–5195. doi:10.1039/C5GC01099C.
- [9] W. Li, J.-H. Xie, H. Lin, Q.-L. Zhou, Highly efficient hydrogenation of biomass-derived levulinic acid to γ -valerolactone catalyzed by iridium pincer complexes, *Green Chem.* 14 (2012) 2388–2390. doi:10.1039/C2GC35650C.
- [10] J. Deng, Y. Wang, T. Pan, Q. Xu, Q.-X. Guo, Y. Fu, Conversion of Carbohydrate Biomass to γ -Valerolactone by using Water-Soluble and Reusable Iridium Complexes in Acidic Aqueous Media, *ChemSusChem.* 6 (2013) 1163–1167. doi:10.1002/cssc.201300245.
- [11] D. Ding, J. Xi, J. Wang, X. Liu, G. Lu, Y. Wang, Production of methyl levulinate from cellulose: selectivity and mechanism study, *Green Chem.* 17 (2015) 4037–4044. doi:10.1039/C5GC00440C.
- [12] H. Heeres, R. Handana, D. Chunai, C.B. Rasrendra, B. Girisuta, H.J. Heeres, Combined dehydration/(transfer)-hydrogenation of C6-sugars (D-glucose and D-fructose) to γ -valerolactone using ruthenium catalysts, *Green Chem.* 11 (2009) 1247–1255. doi:10.1039/B904693C.
- [13] X. Hu, C.-Z. Li, Levulinic esters from the acid-catalysed reactions of sugars and alcohols as part of a bio-refinery, *Green Chem.* 13 (2011) 1676–1679. doi:10.1039/C1GC15272F.
- [14] S. Kang, J. Fu, G. Zhang, From lignocellulosic biomass to levulinic acid: A review on acid-catalyzed hydrolysis, *Renewable and Sustainable Energy Reviews.* 94 (2018) 340–362. doi:10.1016/j.rser.2018.06.016.

- [15] R.A. Bourne, J.G. Stevens, J. Ke, M. Poliakoff, Maximising opportunities in supercritical chemistry: the continuous conversion of levulinic acid to γ -valerolactone in CO₂, *Chem. Commun.* 0 (2007) 4632–4634. doi:10.1039/B708754C.
- [16] M.G. Al-Shaal, M. Calin, I. Delidovich, R. Palkovits, Microwave-assisted reduction of levulinic acid with alcohols producing γ -valerolactone in the presence of a Ru/C catalyst, *Catalysis Communications*. 75 (2016) 65–68. doi:10.1016/j.catcom.2015.12.001.
- [17] X. Tang, H. Chen, L. Hu, W. Hao, Y. Sun, X. Zeng, L. Lin, S. Liu, Conversion of biomass to γ -valerolactone by catalytic transfer hydrogenation of ethyl levulinate over metal hydroxides, *Applied Catalysis B: Environmental*. 147 (2014) 827–834. doi:10.1016/j.apcatb.2013.10.021.
- [18] J. Wojciechowska, M. Jędrzejczyk, J. Grams, N. Keller, A.M. Ruppert, Enhanced Production of γ -Valerolactone with an Internal Source of Hydrogen on Ca-Modified TiO₂ Supported Ru Catalysts, *ChemSusChem*. 12 (2019) 639–650. doi:10.1002/cssc.201801974.
- [19] Y. Wang, L. Vernières-Hassimi, V. Casson-Moreno, J.-P. Hébert, S. Leveneur, Thermal Risk Assessment of Levulinic Acid Hydrogenation to γ -Valerolactone, *Org. Process Res. Dev.* 22 (2018) 1092–1100. doi:10.1021/acs.oprd.8b00122.
- [20] A.S. Piskun, H.H. van de Bovenkamp, C.B. Rasrendra, J.G.M. Winkelman, H.J. Heeres, Kinetic modeling of levulinic acid hydrogenation to γ -valerolactone in water using a carbon supported Ru catalyst, *Applied Catalysis A: General*. 525 (2016) 158–167. doi:10.1016/j.apcata.2016.06.033.

- [21] L. Negahdar, M.G. Al-Shaal, F.J. Holzhäuser, R. Palkovits, Kinetic analysis of the catalytic hydrogenation of alkyl levulinates to γ -valerolactone, *Chemical Engineering Science*. 158 (2017) 545–551. doi:10.1016/j.ces.2016.11.007.
- [22] Y.-Y. Bai, S. Su, S. Wang, B. Wang, R.-C. Sun, G. Song, L.-P. Xiao, Catalytic Conversion of Carbohydrates into 5-Ethoxymethylfurfural by a Magnetic Solid Acid Using γ -Valerolactone as a Co-Solvent, *Energy Technology*. 6 (2018) 1951–1958. doi:10.1002/ente.201800090.
- [23] M.A. Mellmer, D.M. Alonso, J.S. Luterbacher, J.M.R. Gallo, J.A. Dumesic, Effects of γ -valerolactone in hydrolysis of lignocellulosic biomass to monosaccharides, *Green Chem*. 16 (2014) 4659–4662. doi:10.1039/C4GC01768D.
- [24] J. Vojtko, P. Tomčík, A Method for Esterification Reaction Rate Prediction of Aliphatic Monocarboxylic Acids with Primary Alcohols in 1,4-Dioxane Based on Two Parametrical Taft Equation, *International Journal of Chemical Kinetics*. 46 (2014) 189–196. doi:10.1002/kin.20845.
- [25] S. Leveneur, Thermal Safety Assessment through the Concept of Structure–Reactivity: Application to Vegetable Oil Valorization, *Org. Process Res. Dev.* 21 (2017) 543–550. doi:10.1021/acs.oprd.6b00405.
- [26] J.-C. Charpentier, Mass-transfer rates in gas-liquid absorbers and reactors, in: G.R.C. Thomas, B. Drew John, W. Hoopes, Theodore Vermeulen (Eds.), *Advances in Chemical Engineering*, Academic Press, 1981, pp. 1–133.
- [27] N. Frikha, E. Schaer, J.-L. Houzelot, Methodology of multiphase reaction kinetics and hydrodynamics identification: Application to catalyzed nitrobenzene hydrogenation, *Chemical Engineering Journal*. 124 (2006) 19–28. doi:10.1016/j.cej.2006.08.012.

- [28] N. Gemo, P. Biasi, P. Canu, T.O. Salmi, Mass transfer and kinetics of H₂O₂ direct synthesis in a batch slurry reactor, *Chemical Engineering Journal*. 207–208 (2012) 539–551. doi:10.1016/j.cej.2012.07.015.
- [29] X. Cai, J.L. Zheng, J. Wärnå, T. Salmi, B. Taouk, S. Leveneur, Influence of gas-liquid mass transfer on kinetic modeling: Carbonation of epoxidized vegetable oils, *Chemical Engineering Journal*. 313 (2017) 1168–1183. doi:10.1016/j.cej.2016.11.012.
- [30] H. Haario, *MODEST-User's Guide*, Profmath Oy, Helsinki, 2001.
- [31] X. Cai, M. Matos, S. Leveneur, Structure–Reactivity: Comparison between the Carbonation of Epoxidized Vegetable Oils and the Corresponding Epoxidized Fatty Acid Methyl Ester, *Ind. Eng. Chem. Res.* 58 (2019) 1548–1560. doi:10.1021/acs.iecr.8b05510.
- [32] Y. Kawase, M. Moo-Young, Volumetric Mass Transfer Coefficients in Aerated Stirred Tank Reactors with Newtonian and Non-Newtonian Media, *Chem. Eng. Res. Des.* 66 (1988) 284–288.
- [33] C.R. Wilke, P. Chang, Correlation of diffusion coefficients in dilute solutions, *AIChE Journal*. 1 (1955) 264–270. doi:10.1002/aic.690010222.
- [34] X. Cai, K. Ait Aissa, L. Estel, S. Leveneur, Investigation of the Physicochemical Properties for Vegetable Oils and Their Epoxidized and Carbonated Derivatives, *J. Chem. Eng. Data*. 63 (2018) 1524–1533. doi:10.1021/acs.jced.7b01075.
- [35] A.S. Piskun, J.E. de Haan, E. Wilbers, H.H. van de Bovenkamp, Z. Tang, H.J. Heeres, Hydrogenation of Levulinic Acid to γ -Valerolactone in Water Using Millimeter Sized Supported Ru Catalysts in a Packed Bed Reactor, *ACS Sustainable Chem. Eng.* 4 (2016) 2939–2950. doi:10.1021/acssuschemeng.5b00774.

[36] E. Brunner, Solubility of hydrogen in 10 organic solvents at 298.15, 323.15, and 373.15 K, *J. Chem. Eng. Data.* 30 (1985) 269–273. doi:10.1021/je00041a010.

[37] J.V.H. d'Angelo, A.Z. Francesconi, Gas–Liquid Solubility of Hydrogen in n-Alcohols ($1 \leq n \leq 4$) at Pressures from 3.6 MPa to 10 MPa and Temperatures from 298.15 K to 525.15 K, *J. Chem. Eng. Data.* 46 (2001) 671–674. doi:10.1021/je000189u.

[38] S. Raeissi, C.J. Peters, Understanding temperature dependency of hydrogen solubility in ionic liquids, including experimental data in [bmim][Tf₂N], *AIChE Journal.* 58 (2012) 3553–3559. doi:10.1002/aic.13742.